

TGL
TUBE GEAR

Edition 8

PARTS CATALOGUE



All our products, conveniently listed.

This catalogue replaces all previous versions.

Disclaimer

The information compiled in this catalogue has been obtained from a number of various sources. While we have strived to produce an accurate catalogue this information has not been verified. No responsibility for loss occasioned to any person acting or arising from actions as a result of any material in this publication can be accepted by Tube Gear Ltd

Tube Gear Ltd reserve the right to change the information in this catalogue at any time without prior knowledge. Images are for illustrative purposes only and products may vary in finish or other detail without affecting functionality.

Sales are subject to the warranty and limitations applying to the product and relevant manufacturer/supplier. All products are subject to availability, price and Tube Gear Ltd current Terms & Conditions at the time of binding order

Our current terms and conditions are available upon request by contacting Tube Gear Ltd offices or from our web site www.tube-gear.com by clicking on the T&C's link.

Copyright

© 2024 The copyright in the photographic images, drawings and text contained in this catalogue is owned or used under licence by Tube Gear Ltd or the respective Manufacturers

Tube Gear Limited do not advise that any range of fittings or manufacturers brand are used in conjunction with any other range of fittings or manufacturers brand

A-Z / Index

Section 1 Push-in Air Brake

Section 2 Din & Metric Steel Compression Components

Section 3 Industrial Fittings - Push-in

Section 4 Industrial Fittings - Compression

Section 5 Brake Pipe Fittings

Section 6 Air Brake Tubing & Coils

Section 7 Hydraulic & Industrial Tubing

Section 8 General Equipment - Garage & Electrical

Section 9 General Equipment - Valves

Section 10 General Equipment - Chassis

Section 11 Assorted Box Part Number Breakdown

Section 12 Part Number to Page & Unit of Issue

TUBE GEAR LTD



Kent Sales, Accounts & Purchasing Office
Ground Floor Office 1, Courtyard V, Springhead Road Ent Park
Springhead Road, Northfleet, Kent, DA11 8HN

SALES

Tel: 0044 (0) 1474 321954

Customer Service / Sales: Option 1

Purchasing / Supplier Contact: Option 2

Accounts Payable: Option 3

Technical Support: Option 4

Email: orders@tube-gear.com

www.tube-gear.com



West Midlands Office & Distribution
Unit B, Mucklow Hill Trading Estate, Phase 2
Halesowen, West Midlands, B62 8DQ

SALES

Tel: 0044 (0)121 501 1171

Email: oesales@tube-gear.com

Tube Gear Ltd was started in 1982 and has always traded using its initial criteria of "quality products, competitive prices with a second to none service and delivery".

We have always placed quality as one of the key concerns to our business in such a safety critical market place.

We have an ever expanding range of air brake fittings, industrial fittings, industrial tubing, air brake tubing and general transport spares. The ranges are complete and comprehensive to cover any trailer builder or aftermarket requirements.

Our knowledgeable and specialist trained staff at all times ensure our service is tailored to suit any requirement and can assist with the most technical of enquires.

As well as manufacturing our own components we are also main stockists for all the key market suppliers including Norgren, Raufoss, VOSS, John Guest as well as WIRA for whom we are sole UK distributors.

Our Markets - Original Equipment

We believe that our in house engineering and technical design services are the keys to Tube Gear being the substantial supplier to most of the UK's top vehicle and trailer manufactures.

We were the first to design and implement fitting kits and kan-ban systems and are now a supplier who can truly offer a complete design and installation of the "modular valve system" covering most trailer applications.

The systems we design are to help reduce costs and improve efficiency and safety, most importantly the research and development is FREE to the customer.

Aftermarket

We currently have 450 distributors on our customer list which covers the whole of the UK and most major countries across the world. Our distributors have access to the Tube Gear blister packs and display racks as well as our proven sales booster the assorted box displays and Maxi-stor boxes.

We have an ethical view to our distribution policy and we highly value all our customers business and markets and wish to protect their future sales as well as our own.

As part of our ongoing development we purchased Vernon Developments Ltd in 2001. They specialise in the manufacture and supply of chassis and body building components.

We as always will try to "go that bit further" by producing a quality product at a competitive cost with the service and technical development needed in today's fast changing market place.

We look forward to hearing from you soon.

Visit us now at www.tube-gear.com

Tube Gear Ltd are certified to ISO 14001:2015 and ISO 9001:2015
please scan the QR Code for Certificates



TUBE GEAR LTD

A-Z

Description	Page	Description	Page
3 & 4 Way Connectors	5.6	Camozzi C1 Swivel Fittings	1.16 - 1.17
3/2 Button Spring Valves	9.4 - 9.5	Camozzi C Truck Range	1.13 - 1.15
3/2 Emergency Stop Valves	9.4 - 9.5	Chassis Clips	6.4
3/2 Foot Button Valve	9.9	Chassis Components	10.5 - 10.12
3/2 Lever Spring Valves	9.6	Chemical Barrel Syphon Pump	8.8
3/2 Pilot/Spring Valves	9.2 - 9.4	Chemical Pressure Sprayer	8.6
3/2 Push Pull Valves	9.6 - 9.7	Clevis Pins	10.10
3/2 Roller Lever Valves	9.7 - 9.8	Compact Anti-Kink Coils	6.2
3/2 Solenoid Spring Valves	9.9 - 9.11	Compression Fittings - Steel	2.2 - 2.7
5/2 Emergency Stop Valve	9.13	Copper Tube	7.2
5/2 Lever/Lever Valves	9.14 - 9.15	Cotter R Clip	8.3
5/2 Pilot Spring Valves	9.11 - 9.12	Coupling Boxes	10.7
5/2 Push/Pull Valves	9.12 - 9.13	Cupronickel Brake Pipe	7.2
5/2 Toggle/Toggle Valves	9.13	D	
5/3 Lever/Lever/Lever Valves	9.14 - 9.15	Diaphragms	10.10
A		DIN Steel - Fittings	2.2 - 2.7
Adblue & Chemical Nozzles & Pumps	8.8 - 8.9	Drain Taps	2.4
Air Brake and Suspension Test Kit	8.10	Drum Pump	8.7 - 8.8
Air Brake Tubing and Coils	6.2 - 6.7	Drum Taps	8.6
Air Coil Handles	6.3	Dry Brake Coupling	8.4
Air Coils	6.2 - 6.3	E	
Air Hose	6.4 - 6.7	Electric Pump Kit	8.7
Air Operated Greaser Kit	8.5	Electrical Pump Dispensing Kit	8.8
Air Reservoirs	10.2 - 10.4	Exhaust Filters	9.19
Assorted Storage Boxes	1.1A, 11.1 - 11.10	Exhaust Guards	9.20
Aromatic Greasing Systems	8.5	F	
Auto Chassis Lube Filler Pump	8.4	Filter Regulators	9.21
Automatic Shut Off Nozzle	8.7	Flaring Tool	5.9, 7.3
B		Flexi-spout Oil Measure	8.6
Blanking Plug	1.12, 1.15, 2.3	Fuel Hose	7.4
Bleed Screws	5.7	Funnels	8.6
Blow Guns	3.15	G	
Bolt-on Stay Fast Latch	10.5	Garage Equipment	8.6 - 8.9
Brake Cleaner & Chemical Pressure Sprayer	8.6	Grease Bucket Pump	8.4
Brake Pipe Nuts	5.2 - 5.5	Grease Control Gun	8.5
Brass Compression Fittings	4.2 - 4.6	Grease Equipment	8.2 - 8.5
Buffers	10.8 - 10.9	Grease Nipples	8.2 - 8.3
C		H	
C & CA Coupling Covers	2.19	Handbrake Compensator	10.12
C & CA Coupling Grips	2.17	Heater Hose	7.5
C & CA Coupling Tester	2.19	Hose Tails	2.8 - 2.9
C & CA Couplings	2.17 - 2.19	I	
C & CA Dummy Couplings	2.19	Industrial Air Hose	7.5
Cable	10.11	Industrial Fittings	3.2 - 4.8
Cable Grips	10.11	Industrial Fittings - Norgren	3.2 - 3.4
Cable Retainer Clear	10.6	In-line Filter	2.20
Cable Ties	6.5		

TUBE GEAR LTD

A-Z

Description	Page	Description	Page
L		T	
Lever Drum Pump	8.7	Test Points	1.9, 1.26, 1.27, 2.16
Linch Pin	8.3	Thread Adaptors	2.7
M		Thread Sealant	2.3
Main Ring Air Fittings	3.9	Trailer C Locks	2.19
Malleable Iron Fittings	4.7 - 4.8	Trailer Hand Brake	10.12
Manifolds	2.21	Trailer Park Valve	9.19
Metric Steel - Fittings	2.2 - 2.7	Tube Cutters	6.7
N		Tube Supports	2.5
Non-Return Valves	9.17 - 9.18	Tyre Inflation Components	3.15
Norgren Fleetfit - For Imperial Tube	1.32 - 1.33	U	
Norgren Fleetfit - For Metric Tube	1.28 - 1.31	Unicoils	6.2 - 6.3
Norgren Industrial Fittings	3.2 - 3.4	V	
Nylon Air Tube	6.6 - 6.7	Visi Winks	9.15 - 9.16
O		Voss Fittings - 230	1.34 - 1.36
O Clips	6.5	Voss Fittings - 232	1.37 - 1.38
P		W	
Palm Couplings	2.20	Wheel Nut	10.9
Pilot Blocking Valves	9.18	Winding Handles	10.11
Pipe Clips	6.5, 7.4	Wira - Fittings	1.18 - 1.27
Plastic PIF Fittings	3.5 - 3.9	Wira - Fittings	2.10 - 2.15
Plastic Sprayer Bottles	8.6	Workshop / Forecourt Coils	7.5 - 7.6
Port Extensions	2.8	Worm Drive Clips	6.5
Pressure Gauges	9.20	Worm Drive Screw Driver	6.5
Pressure Regulators	9.16 - 9.17	Y	
PTFE Tape	4.8	Yoke & Pin Assemblies	10.10
Punch & Die Sets	5.9		
PVC Tubing	7.4		
Q			
Quick Release Air Line Couplings	3.11 - 3.14		
Quick Release Coupler	8.3		
R			
Raufoss - Metric / Imperial	1.10 - 1.12		
Raufoss - New Line	1.2 - 1.9		
Rigid Nylon Tubing	7.4		
Rubber Air Hose	6.4		
S			
SAE Fittings	5.8		
Sealant - Thread	2.3		
Side Guard Legs	10.8		
Side Lever Grease Gun	8.4		
Silencers	9.19 - 9.20		
Spring Hooks & Chains	10.5		
Spring Loaded Door Retainer	10.6		

TUBE GEAR LTD

Product Display

Universal Packet Display System

This display system is intended to simplify the stocking and managing of the Tube Gear blister pack range. It is ideal for placing products in a shop front area to maximise the impulse buy potential of a highly consumable range of fittings.

When teamed with part numbered red backing cards, stock taking and reordering becomes a simple task and the clear plastic packets with colour coded cards keep the stock clean and make identification easy.

Part No. ZHOOK

Consists of one row of hooks that has 8 product prongs; these can hold up to 4 of the large size blister packs and up to 8 of the smaller sized packets.

They hook together vertically to form any length drop of rows, the top row being the only section that needs to be fixed to a permanent backing e.g. counter wall area or racking bins.



Stock Packages

Wall mounting racking does not come preloaded with stock.

Fast moving stock packages can be tailored to suit customer's requirements.

Please contact your local representative for details.



TUBE GEAR LTD

Assorted Boxes

Maxi-stor Assorted Box



Part No.	Description	See Page
MSK240	Plastic push in	3.5
MSK300	Brass olives	4.4
MSK330	Brass compression metric	4.4
MSK470	Voss 230 range	1.35
MSK475	Voss 232 range	1.37
MSK650	Norgren fleet fit push-in	1.31
MSK703	Wira push in range	1.21
MSK760	Thread adaptors	2.7
MSK764	Sealing rings	2.4
MSK770	Wira compression range	2.11
MSK802	Raufoss newline fittings	1.4
MSK805	Raufoss newline fittings	1.4
MSK811	Emergency Repair Kit	1.15
MSK812	Camozzi C1 Range	1.17
MSK813	Camozzi C Truck Range	1.15

Megabox Assorted Kit



Part No.	Description	See Page
MSK820	Raufoss Newline	1.4
MSK830	Camozzi	1.15

For a breakdown of all the parts listed in our assorted boxes see section 11

Standard Assorted Box



Part No.	Description	See Page
2000	O clips	6.5
2026	Coil end adaptors	6.3
2030A	Worm drive clips	6.5
2400	Plastic push in straights imperial	3.9
2420	Plastic push in straights metric	3.5
2430	Plastic push in straights & elbows	3.5
2490	Plastic push in reducers & stems	3.8
2720	Metric plastic plugs	3.7
3000	Imperial stepped olives	4.4
3010	Imperial barrel olives	4.4
3020	Metric stepped olives	4.2
3030	Metric barrel olives	4.2
3100	Tube supports	2.5
3200	Imperial straight compression	4.5
3300	Metric straight compression	4.2
4678A	Pro release tool assorted box	1.4
6500A	Brass push in straights	1.31
6500M	Brass push in straights	1.31
6500P	Brass push in straights	1.31
6600A	Brass push in straight studs	1.31
7000	Male brake pipe nuts	5.6
7030A	Wira end fittings	1.22
7100	Female brake pipe fittings	5.6
7500	Grease nipples	8.2
7589	M/F adaptors metric/imp	2.7
7590	M/F adaptors imp/metric	2.7
7635A	Aluminium seals	2.4
7638	Thrust and o rings	2.4
7639	Metric cutting rings	2.5
7657A	Copper seals	2.4
7669A	Bonded seals	2.4
CC7400A	Camozzi Release Tools	1.15
Z2430	Plastic push in unequal straights	3.7
Z4450	Plastic push in tees metric	3.5
Z4470	Plastic push in elbows metric	3.5
R99000000	Raufoss Tube Release Tools	1.4

Page 1.2 - 1.9

Raufoss New Line

The New Line Building Block System is a 2 step connection. The parts are pressed together by hand. The connections swivel and building blocks can be turned for positioning.

Page 1.10 - 1.12

Raufoss Metric

The Raufoss fitting programme is a unique and extremely simple method of 'piping up' truck and trailers. A system of 'building blocks' it consists of a limited number of components which very simply plug together.

Page 1.13 - 1.15

Camozzi C Truck

Camozzi series C push-in fittings have been designed for use in the braking system on the commercial vehicles and are certified to TUV standards

Page 1.16 - 1.17

Camozzi C1 Swivel

Camozzi series C1 swivel push-in fittings have been designed for use in the braking system on the commercial vehicles and are certified to TUV standards

Page 1.18 - 1.27

Wira

The Wira push-in fitting is designed to be quick and easy to use, extremely versatile and totally secure. Supplied as complete assemblies, considerably reducing labour costs by eliminating the need to build the connectors.

Page 1.28 - 1.33

Norgren

The Norgren FleetFit Push-In Fittings are a range of dedicated fittings designed to reduce the installation time to a minimum, whilst ensuring a secure seal on vehicle air braking and suspension system.

Page 1.34 - 1.36

Voss 230

The 230 product range splits into two main types, type NG 8 and type NG 12. Original equipment fitment on most Mercedes after 1980 and on most DAF's after 1995. Also fitted to MAN 2000 range of vehicles.

Page 1.37 - 1.38

Voss 232

The 232 product range splits into two main types, type NG 8 and type NG 12. Original equipment fitment on most Mercedes after 1980 and on most DAF's after 1995. Also fitted to MAN 2000 range of vehicles.

Tube Gear Limited do not advise that any range of fittings or manufacturers brand are used in conjunction with any other range of fittings or manufacturers brand

Disclaimer: Tube Gear Limited deals in the sale and supply of TUV approved Air Brake Fittings and Ancillary Parts/Components. It does not provide any legally binding technical advise. The customer is urged to take independent advise in regards of fitting the correct fitting to the correct application, in relation to approved braking system fittings.

Raufoss New Line Fittings

INSTRUCTION FOR TUBE RELEASE

Push the tube to the bottom of the coupling to move the grip ring out of locking position.



Check that the Release Tool is not damaged or blunt.
Apply Release Tool on to tube ensuring tight contact between Release Tool and tube



Push the Release Tool to stop with flange at the top of the coupling without using excessive force. (Silicone spray can be used to ease the injection of Release Tool).



While pushing the Release Tool towards the coupling pull the tube out (Rotating the tube may ease the release).
Remove the Release Tool



Ensure that the tube end is clean and undamaged. If not cut the tube end
Clean the inside of the push-in coupling (tube section), using compressed air, to remove possible contamination, ensure that no dirt goes inside the port
Push in the clean tube

It is recommended that a single push in coupling should be reused a maximum of 5 tube assemblies and releases in its lifetime.

Assembly of the New Line Building Block System

It is not permitted to mix the Newline Building Block Systems with similar systems produced by other manufacturers



The Swivel should be mounted with the recommended torque. Remove the protection cap after mounting, directly before assembling Building Block.

The New Line Building Block System is a 2 step connection. The parts are pressed together by hand. The connection swivel and building block can be turned for positioning.

When reaching the 1st (safety) position only, a controlled leakage will be discharged, this is slightly audible. Depending on the dimension and accessibility the connection can be re-pressed under pressure and is then sealed.

Important recommendations

Torque Settings

Thread	Recommended Torque ^{1,2}	Max Torque ²	Thread	Recommended Torque ^{1,2}	Max Torque ²
M10x1	15 Nm (11.1 lbf ft)	18 Nm (13.3 lbf ft)	M22x1.5	34 Nm (25.1 lbf ft)	40 Nm (29.5 lbf ft)
M12x1.5	20 Nm (14.8 lbf ft)	24 Nm (17.7 lbf ft)	M26x1.5	43 Nm (31.7 lbf ft)	50 Nm (36.9 lbf ft)
M14x1.5	24 Nm (17.7 lbf ft)	28 Nm (20.7 lbf ft)	1/8"	15 Nm (11.1 lbf ft)	18 Nm (13.3 lbf ft)
M16x1.5	30 Nm (22.1 lbf ft)	35 Nm (25.8 lbf ft)	1/4"	24 Nm (17.7 lbf ft)	28 Nm (20.7 lbf ft)
M18x1.5	30 Nm (22.1 lbf ft)	35 Nm (25.8 lbf ft)	3/8"	32 Nm (23.6 lbf ft)	38 Nm (28.0 lbf ft)

In the below cases use the Rotolock in combination with New Line Building Block

- Connection between truck and trailer (e.g. brake hose/Air coils)
- Between axle and chassis (e.g. brake hose)
- The orientation has to be fixed

Assembly of Rotolock

- 1/ Press Rotolock + Newline Building Block together
- 2/ Plug this assembly on top of the swivel (1st safety position).
- 3/ Define the orientation.
- 4/ Click the New Line Building Block into the 2nd/locked position.



Release of Raufoss New Line Building Block

To release the New Line Building Block use the circlip pliers (Part No 6921). Insert the pliers into the snap arms and expand the pliers. Pull out the coupling from the union. The Building Block is free from the union. The parts are reusable as long as no visible damage appears.



Raufoss New Line System

A new generation of couplings, based on composite materials in combination with leading coupling technology.

The system will provide significant improvement in key coupling areas, and enable Raufoss to take broader responsibility in pneumatic system building on commercial vehicles.

New composite materials reduce system cost, weight, article numbers and increases design flexibility.

Brass components secure structural integrity in highly stressed areas.

One global system, fulfilling different engineering philosophies within truck, bus, trailer, off-road applications



Tube Gear Limited do not advise that any range of fittings or manufacturers brand are used in conjunction with any other range of fittings or manufacturers brand

System Release Pliers Part No. 6921



Note: Port Sizes come in Small Regular & Large

Swivel Type	To Suit Tube Size	Cap Colour	Dimensions
Small	6 x 1mm - 8 x 1mm	White	15mm
Regular	6 x 1mm - 12 x 1.5mm	Green	17mm
Large	12 x 1.5mm - 14 x 2mm 15 x 1.5mm - 16 x 2mm	Blue	20mm



Colour caps for different sizes

Assorted Boxes



Maxi-Stor Boxes
Raufoss new line kits
Part No. MSK802
Part No. MSK805

Mega Box
Raufoss new line kit
Part No. MSK820



For a breakdown of all assorted boxes see section 11

Tube Release Tool



Tube Size	Part No.	Pack Part No.
6mm	4662	RA762
8mm	4663	RA763
10mm	4664	RA764
12mm	4665	RA765
15mm	4666	RA766
16mm	4667	RA767

Assorted Box Part No. 4668A

Professional Tube Release Tool



Tube Size	Part No.
6mm	R99060200
8mm	R99080200
10mm	R99100200
12mm	R99120200
15mm	R99150200
16mm	R99160200

Assorted Box Part No. R99000000

Male Stud Coupling



Thread	Tube	Part No.	Pack Part No.
M16 x 1.5	6 x 1	R01061600	RA702
M22 x 1.5	6 x 1	R01062200	RA704
M16 x 1.5	8 x 1	R01081600	RA708
M22 x 1.5	8 x 1	R01082200	RA709
M22 x 1.5	10 x 1	R01102201	RA727
M22 x 1.5	10 x 1.25	R01102202	RA714
M22 x 1.5	10 x 1.5	R01102203	RA728
M22 x 1.5	12 x 1.5	R01122200	RA718

Male Stud Coupling



Thread	Tube	Part No.	Pack Part No.
M10 x 1	6 x 1	R01061000	
M10 x 1	8 x 1	R01081000	RA705
M10 x 1	10 x 1	R01101001	
M10 x 1	10 x 1.5	R01101003	
M10 x 1	12 x 1.5	R01121000	
M12 x 1.5	6 x 1	R01061200	RA700
M12 x 1.5	8 x 1	R01081200	RA706
M12 x 1.5	10 x 1	R01101201	RA723
M12 x 1.5	10 x 1.25	R01101202	RA710
M12 x 1.5	10 x 1.5	R01101203	RA724
M12 x 1.5	12 x 1.5	R01121200	RA715
M12 x 1.5	16 x 2	R01161200	
M12 x 1.5	1/4	R01126350	
M14 x 1.5	6 x 1	R01061400	RA701
M14 x 1.5	8 x 1	R01081400	RA707
M14 x 1.5	10 x 1	R01101401	
M14 x 1.5	10 x 1.25	R01101402	
M14 x 1.5	10 x 1.5	R01101403	
M14 x 1.5	12 x 1.5	R01121400	
M14 x 1.5	15 x 1.5	R01151400	
M16 x 1.5	10 x 1	R01101601	RA725
M16 x 1.5	10 x 1.25	R01101602	RA712
M16 x 1.5	10 x 1.5	R01101603	RA726
M16 x 1.5	12 x 1.5	R01121600	RA716
M16 x 1.5	15 x 1.5	R01151600	
M16 x 1.5	16 x 2	R01161600	RA717
M16 x 1.5	1/4	R01635160	
M16 x 1.5	3/8	R01953160	
M16 x 1.5	1/2	R01127160	
M16 x 1.5	5/8	R01159160	
M22 x 1.5	15 x 1.5	R01152200	RA720
M22 x 1.5	16 x 2	R01162200	RA722
M26 x 1.5	15 x 1.5	R01152600	

Male Swivel Stud



Type	Thread Size	Hex	Part No.	Pack Part No.
Small	M12 x 1.5	18	R10011200	
Small	M16 x 1.5	22	R10011600	
Regular	M10 x 1	18	R10021000	RA772
Regular	M12 x 1.5	18	R10021200	RA773
Regular	M14 x 1.5	20	R10021400	RA774
Regular	M16 x 1.5	22	R10021600	RA775
Large	M16 x 1.5	22	R10031600	
Regular	M22 x 1.5	28	R10022200	RA777
Large	M22 x 1.5	28	R10032200	
Small	1/8NPT	16	R10013175	
Regular	1/8NPT	16	R10023175	
Small	1/4NPT	16	R10016350	
Regular	1/4NPT	18	R10026350	
Regular	3/8NPT	18	R10029530	
Large	3/8NPT	22	R10039530	
Regular	1/2NPT	22	R10021270	
Large	1/2NPT	22	R10031270	

Male Stud Connectors



Thread Size	Tube Size	Part No.
M10 x 1.5	4 x 1	R01041000
M12 x 1.5	4 x 1	R01041200

Stud Elbow Adaptors



Tube Size	Thread Size	Part No.
6 x 1	M10 x 1	R03020610
6 x 1	M12 x 1.5	R03020612
6 x 1	M16 x 1.5	R03020616
6 x 1	M22 x 1.5	R03020622
8 x 1	M10 x 1	R03020810
8 x 1	M12 x 1.5	R03020812
8 x 1	M14 x 1.5	R03020814
8 x 1	M16 x 1.5	R03020816
8 x 1	M22 x 1.5	R03020822
10 x 1	M10 x 1	R030210101
10 x 1.25	M10 x 1	R030210102
10 x 1.5	M10 x 1	R030210105
10 x 1	M12 x 1.5	R030210121
10 x 1.25	M12 x 1.5	R030210122
10 x 1.5	M12 x 1.5	R030210125
10 x 1	M14 x 1.5	R030210141
10 x 1.25	M14 x 1.5	R030210142
10 x 1.5	M14 x 1.5	R030210145
10 x 1	M16 x 1.5	R030210161
10 x 1.25	M16 x 1.5	R030210162
10 x 1.5	M16 x 1.5	R030210165
10 x 1	M22 x 1.5	R030210221
10 x 1.25	M22 x 1.5	R030210222
10 x 1.5	M22 x 1.5	R030210225
12 x 1.5	M10 x 1	R03021210
12 x 1.5	M12 x 1.5	R03021212
12 x 1.5	M16 x 1.5	R03021216
12 x 1.5	M22 x 1.5	R03021222
15 x 1.5	M22 x 1.5	R03021522
16 x 2	M16 x 1.5	R03021616
16 x 2	M22 x 1.5	R03021622

Bulk Head Coupling - Swivel



Type	Thread A	Thread B	Part No.
Regular	M16 x 1.5	M22 x 1.5	R17021622
Regular	M22 x 1.5	M22 x 1.5	R17022222

Bulk Head Coupling - Swivel



Type	Female Thread	Male Thread	Part No.
Regular	M16 x 1.5	M22 x 1.5	R14021622

Bulk Head Coupling - Swivel



Type	Male Thread	Part No.
Regular	M18 x 1.5	R15020018

Female Swivel Stud



Thread	Type	Part No.
M10 x 1.0	Regular	R66021000
M12 x 1.5	Regular	R66021200
M16 x 1.5	Regular	R66021600
M22 x 1.5	Regular	R66022200

Threadless Plug



Type	Part No.
Regular	R68020000

Threadless Coupling



Type	Tube OD	Part No.
Regular	4 x 1	R02020400

Threadless Coupling



Type	Tube	Part No.	Pack No.
Regular	6 x 1	R02020600	RA731
Small	8 x 1	R02010800	
Regular	8 x 1	R02020800	RA733
Regular	10 x 1	R02021001	
Regular	10 x 1.25	R02021002	RA734
Regular	10 x 1.5	R02021003	
Regular	12 x 1.5	R02021200	RA735
Large	12 x 1.5	R02031200	
Large	14 x 2	R02031400	
Large	15 x 1.5	R02031500	
Large	16 x 2	R02031600	

Internal 90 Degree Elbow



Type	Tube	Part No.	Pack No.
Small	6 x 1	R03010600	
Regular	6 x 1	R03020600	RA741
Small	8 x 1	R03010800	
Regular	8 x 1	R03020800	RA743
Regular	10 x 1	R03021001	
Regular	10 x 1.25	R03021002	RA744
Regular	10 x 1.5	R03021005	
Regular	12 x 1.5	R03021200	RA745
Large	15 x 1.5	R03031500	
Large	16 x 2	R03031600	

Tee Connectors



Tube Size	Part No.
6 x 1	R52000600
8 x 1	R52000800
10 x 1	R520010001
10 x 1.25	R520010002
10 x 1.5	R520010005
12 x 1.5	R52001200
15 x 1.5	R53001500
16 x 2	R53001600

Elbow Connectors



Tube Size	Part No.
6 x 1	R03000600
8 x 1	R03000800
10 x 1	R030010001
10 x 1.25	R030010002
10 x 1.5	R030010005
12 x 1.5	R03001200

Straight Connectors



Tube	Part No.	Pack No.
6 x 1	4566C	RA780
8 x 1	4567C	RA781
10 x 1	4568C	RA782
10 x 1.25	4569C	RA783
10 x 1.5	4570C	RA784
12 x 1.5	4571C	RA785
15 x 1.5	4572C	

Four Way Coupling



Type	Part No.
Regular	R92000000
Large	R93000000

Three Way Coupling



Type	Part No.
Regular	R72000000

F Type Coupling



Type	Part No.
Regular	R42000000
Large	R43000000

Cross Type Coupling



Type	Part No.
Regular	R82000000
Large	R83000000

Y Type Coupling



Type	Part No.
Small	R61000000
Regular	R62000000

In Line Adaptor - Female



Size 1	Size 2	Part No.
Regular	Regular	R12000000

T Coupling



Type	Part No.	Pack No.
Small	R51000000	
Regular	R52000000	RA754
Large	R53000000	

90 Degree Elbow



Type	Part No.	Pack No.
Regular	R32000000	RA750
Large	R33000000	

45 Degree Elbow



Type	Part No.	Pack No.
Small	R21000000	
Regular	R22000000	RA752

Threadless Adaptor - Male



Size 1	Size 2	Part No.	Pack No.
Regular	Regular	R65020200	RA756
Regular	Large	R65020300	

Threadless Reducer



Type M	Type F	Part No.
Large	Regular	R75020300

Threadless Test Point



Type	Part No.	Pack No.
Regular	R60020000	RA760

Rotolock



Type	Spanner Size	Part No.	Pack Part No.
Small	22mm	R64012200	
Regular	18mm	R64021800	
Regular	22mm	R64022200	RA795
Regular	28mm	R64022800	RA796
Large	28mm	R64032800	

Blanking Plug



Tube	Type	Part No.
6mm	Regular	R040106
8mm	Regular	R040108
12mm	Regular	R040112

Straight Connector

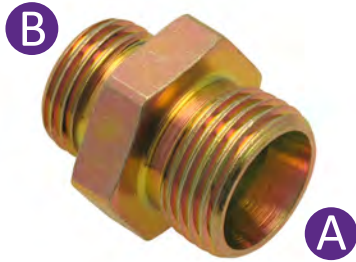

Thread A	Thread B	Cone	Part No
M18 x 1.5	M16 x 1.5	24 Deg	4633R

Locking Nut With O Ring



Thread Size	Part No
M14 x 1.5	4639R

Lock Nut Without O Ring



Thread Size	Part No
M22 x 1.5	4628

Straight Bulkhead Adaptor



Male Thread Size	Female Thread Size	Part No	Pkt No
M22 x 1.5	M16 x 1.5	4630	RA630

Straight Bulkhead Adaptor



Thread A	Thread B	Part No
M16 x 1.5	M16 x 1.5	4632

Lock Nut With O Ring



Thread Size	Part No
M12 x 1.5	4640
M16 x 1.5	4641
M22 x 1.5	4642

Straight Bulkhead Adaptor



Male Thread Size	Female Thread Size	Part No	Pkt No
M18 x 1.5	M16 x 1.5	4613	RA613

Straight Bulkhead Adaptor



Thread A	Thread B	Thread C	Part No	Pkt No
M22 x 1.5	M22 x 1.5	M16 x 1.5	4499	RA499
M16 x 1.5	M22 x 1.5	M16 x 1.5	4631	RA631
M22 x 1.5	M16 x 1.5	M10 x 1	4494	

Equal Tee Adaptor



Thread Size	Part No	Pkt No
M12 x 1.5	4593	RA593
M16 x 1.5	4594	RA594
M22 x 1.5	4595	RA595

Equal Tee Adaptor With Bracket



Thread Size	Part No	Pkt No
M16 x 1.5	4596	RA596

90 Degree Equal Elbow Adaptor



Thread Size	Part No	Pkt No
M12 x 1.5	4581	RA581
M16 x 1.5	4582	RA582
M22 x 1.5	4583	RA583

Branch Stud Tee



Thread Size	Part No
M16 x 1.5	4643

Side Stud Tee

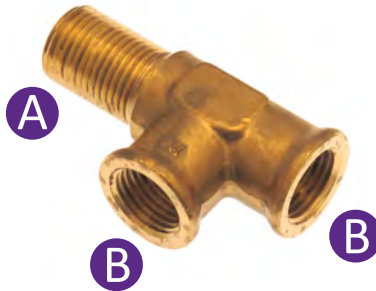

Thread A	Thread B	Part No
M16 x 1.5	M16 x 1.5	4651
M22 x 1.5	M16 x 1.5	4652

Side Stud Tee C/W Lock Nut



Thread A	Thread B	Part No
M16 x 1.5	M16 x 1.5	4661

90 Degree Elbow Adaptor



Female Thread Size	Male Thread Size	Part No	Pkt No
M12 x 1.5	M12 x 1.5	4584	RA584
M16 x 1.5	M16 x 1.5	4585	RA585
M16 x 1.5	M22 x 1.5	4586	RA586

90 Degree Elbow Adaptor Male to Female



Thread A	Thread B	Thread C	Part No	Pkt No
M16 x 1.5	M16 x 1.5	N/A	4587	RA587
M16 x 1.5	M22 x 1.5	M16 x 1.5	4588	RA588
M22 x 1.5	M22 x 1.5	M16 x 1.5	4670	

45 Degree Elbow Adaptor



Female Thread	Male Thread	Part No
M16 x 1.5	M16 x 1.5	4497
M22 x 1.5	M22 x 1.5	4498

Blanking Plug With O Ring



Thread Size	Part No
M12 x 1.5	4717
M16 x 1.5	4715
M22 x 1.5	4716

Female Socket



Thread Size	Part No
M16 x 1.5	4645
M22 x 1.5	4646

Camozzi Fittings

Camozzi series C-Truck push-in fittings have been designed for use in the braking system on the commercial vehicles and are certified to TUV standards. Tubes can be connected and disconnected quickly, without having to remove the fitting from the vehicle, All fittings are supplied pre-assembled and are therefore ready to use. The body, tube insert, collet and locking nut are made from brass and are therefore highly resistant to corrosion. A protective cover, made from a special rubber which is resistant to oils and petrol, keeps humidity and dirt away from the collet.

Each fitting can be used in extreme temperatures (-50°C to +100°C.) and even when there are extreme changes in temperature a secure tube connection is maintained due to the insert which is designed to keep the dimensions of the tube constant. A self sealing O-ring, also resistant to oils and petrol, is situated in a special groove in the thread, ensuring there is no damage during assembly. The working pressure is in accordance with the nylon tube used, with a maximum valve of 16 bar. C-Truck fittings, and the connecting tubes, are in compliance with the following standards: DIN 74324:1996, DIN EN ISO 9227:2006, DIN EN 60068-2-6:1996, GOST 4364-81 and GOST R 51190-98

Materials	Brass Body, collet and locking nuts and insert: zinc plated steel locking nut, technopolymer insert NBR O-ring seal on threads
Thread	Metric
Working Pressure	0 to 16 bar
Maximum Pressure	According to the nylon tube specification
Tube	Hytrel or Polyamide tubing according to DIN 73378, DIN 74324 or ISO 7628 tube dimensions 6x1, 8x1, 10x1, 10x1.25, 10x1.5, 12x1.5, 15x1.5, 16x2, 18x2
Fluid	Compressed Air
Temperature	-50 to + 100°C. (see tube specification)

Tube Gear Limited do not advise that any range of fittings or manufacturers brand are used in conjunction with any other range of fittings or manufacturers brand

Straight Coupling



Tube OD	Part No	Pkt No.
6 x 1mm	CC6502	CAM302
8 x 1mm	CC6504	CAM304
10 x 1mm	CC6506	CAM306
10x1.25mm	CC6506.25	CAM306.25
10 x 1.5mm	CC6506.5	CAM306.5
12 x 1.5mm	CC6508	CAM308
15 x 1.5mm	CC6511	CAM311
16 x 2mm	CC6512	
18 x 2mm	CC6509	

Elbow Coupling



Tube OD	Part No	Pkt No.
6 x 1mm	CC6533	CAM333
8 x 1mm	CC6535	CAM335
10 x 1mm	CC6537	CAM337
12 x 1.5mm	CC6539	CAM339

Branch Stud Tee



Tube OD	Thread Size	Part No
6x1mm	M10x1	CC22060610
6x1mm	M12x1.5	CC22060612
6x1mm	M16x1.5	CC22060616
8x1mm	M12x1.5	CC22080812
8x1mm	M16x1.5	CC22080816
8x1mm	M22x1.5	CC22080822
10x1mm	M16x1.5	CC6638
10x1.5mm	M16x1.5	CC6638.5
10x1mm	M22x1.5	CC6639
10x1.5mm	M22x1.5	CC6639.5

Male Stud 90 Degree Elbow



Tube OD	Thread Size	Part No	Pkt No.
6 x 1mm	M12 x 1.5	CC6602	CAM402
6 x 1mm	M16 x 1.5	CC6603	CAM403
8 x 1mm	M12 x 1.5	CC6604	CAM404
8 x 1mm	M14 x 1.5	CC6607	CAM407
8 x 1mm	M16 x 1.5	CC6605	CAM405
8 x 1mm	M22 x 1.5	CC6606	CAM406
10 x 1mm	M12 x 1.5	CC6610	CAM410
10 x 1mm	M16 x 1.5	CC6613	CAM413
10 x 1mm	M22 x 1.5	CC6614	CAM414
10 x 1.25mm	M12 x 1.5	CC6610.25	CAM410.25
10 x 1.25mm	M16 x 1.5	CC6613.25	CAM413.25
10 x 1.25mm	M22 x 1.5	CC6614.25	CAM414.25
10 x 1.5mm	M12 x 1.5	CC6610.5	CAM410.5
10 x 1.5mm	M16 x 1.5	CC6613.5	CAM413.5
10 x 1.5mm	M22 x 1.5	CC6614.5	CAM414.5
12 x 1.5mm	M16 x 1.5	CC6619	CAM419
12 x 1.5mm	M22 x 1.5	CC6620	CAM420
16 x 2mm	M16 x 1.5	CC6625	CAM425
16 x 2mm	M22 x 1.5	CC6626	CAM426

Male Stud



Tube OD	Thread Size	Part No	Pkt No.
6 x 1mm	M10 x 1	CC4502	CAM502
6 x 1mm	M12 x 1.5	CC4503	CAM503
6 x 1mm	M14 x 1.5	CC4504	CAM504
6 x 1mm	M16 x 1.5	CC4505	CAM505
6 x 1mm	M22 x 1.5	CC4506	CAM506
8 x 1mm	M10 x 1	CC4507	CAM507
8 x 1mm	M12 x 1.5	CC4508	CAM508
8 x 1mm	M14 x 1.5	CC4509	CAM509
8 x 1mm	M16 x 1.5	CC4510	CAM510
8 x 1mm	M22 x 1.5	CC4511	CAM511
10 x 1mm	M10 x 1	CC4512	CAM512
10 x 1mm	M12 x 1.5	CC4513	CAM513
10 x 1mm	M16 x 1.5	CC4515	CAM515
10 x 1mm	M22 x 1.5	CC4516	CAM516
10 x 1.25mm	M12 x 1.5	CC4517	CAM517
10 x 1.25mm	M16 x 1.5	CC4519	CAM519
10 x 1.25mm	M22 x 1.5	CC4520	CAM520
10 x 1.5mm	M12 x 1.5	CC4522	CAM522
10 x 1.5mm	M16 x 1.5	CC4524	CAM524
10 x 1.5mm	M22 x 1.5	CC4525	CAM525
12 x 1.5mm	M12 x 1.5	CC4527	CAM527
12 x 1.5mm	M14 x 1.5	CC4528	CAM528
12 x 1.5mm	M16 x 1.5	CC4529	CAM529
12 x 1.5mm	M22 x 1.5	CC4530	CAM530
15 x 1.5mm	M22 x 1.5	CC4533	CAM533
16 x 2mm	M16 x 1.5	CC4536	CAM536
16 x 2mm	M22 x 1.5	CC4537	CAM537

Side Run Tee



Tube OD	Thread Size	Part No
6 x 1mm	M10 x 1	CC23100606
6 x 1mm	M12 x 1.5	CC23120606
8 x 1mm	M12 x 1.5	CC23120808
8 x 1mm	M16 x 1.5	CC23160808
12 x 1.5mm	M16 x 1.5	CC23161212
15 x 1.5mm	M16 x 1.5	CC23161515

Cross Fitting



Thread	Part No.
M16 x 1.5	CC6850

Female Tee Connector



Thread Size	Part No.	Pkt No.
M22 x 1.5	CC4595	CAM595

Equal Tee Connector



Tube OD	Part No	Pkt No.
6 x 1mm	CC6517	CAM317
8 x 1mm	CC6519	CAM319
10 x 1mm	CC6521	CAM321
10 X 1.5mm	CC6521.5	CAM321.5
12 x 1.5mm	CC6523	CAM323

Release Tool



Tube OD	Part No	Pkt No.
6mm	CC7406	CAM7406
8mm	CC7408	CAM7408
10mm	CC7410	CAM7410
12mm	CC7412	CAM7412
15mm	CC7415	CAM7415
16mm	CC7416	CAM7416

Assorted Boxes

Emergency repair kit Part No. MSK811

C truck kit Part No. MSK813

Camozzi assorted kit Part No. MSK830

Release Tool Kit Part No. CC7400A

For a breakdown of all assorted boxes see section 11

Blanking Plug



Thread	Part No.
M12 x 1.5	7621SB
M16 x 1.5	7622SB
M22 x 1.5	7623SB

3 Way Block Connector



F Thread	M Thread	Part No.
M16 x 1.5	M16 x 1.5	CC6860
M16 x 1.5	M22 x 1.5	CC6861

Female Tee C/W Bracket



Thread	Part No.
M16 x 1.5	CC4596

Y Fitting



Tube Size	Thread	Part No.
8 x 1mm	M16 x 1.5	CC6830
12 x 1.5mm	M22 x 1.5	CC6831

Unequal Tee Connector



Tube OD A	Tube OD B	Part No.
12mm	8mm	CC6532
8mm	6mm	CC6529

F Fitting



Tube Size	Thread	Part No.
12 x 1.5mm	M22 x 1.5	CC6840

Assembly of Swivel Connectors

For Swivel Connectors, please install manually according to the following instructions, Attention: Swivel connectors should not be used in applications with relative movement (e.g. connections between truck & trailer or between axle and chassis)

1. Mount the stud onto the port, We recommend removing the cap immediately before you mount the female part to the stud in order to prevent dirt on or damage to the O rings.



2. Position the female part on the stud. If you want to use an anti-rotation lock, attach this to the female part before you connect to the stud.



3. Now press down the upper part completely. The assembly is now complete.

Note: This connection cannot be disassembled again.



4. The swivel connector is now completed and ready for the tube to be inserted.

The connector can be rotated to the necessary position (360° swivelling). If you have added a rotation lock and the connector is still swivelling, this is because you have not yet engaged the lock.



5. To engage the rotation lock, bring the upper part to a position that lets you press it down to interlock with the hexagon of the stud.

Then press the locking ring down. The connector is now fixed in position.

Attention: The lock is a positioning support for line routing. It is not meant to withstand excessive bending forces



Push in Air Brake Camozzi C1 Swivel Fittings

Swivel Elbow



Tube Size	Swivel	Part No	Pkt No.
6 x 1mm	C1	CC4573	CAM573
8 x 1mm	C1	CC4574	CAM574
10 x 1.25mm	C1	CC4575	CAM575
10 x 1.5mm	C1	CC4576	CAM576
12 x 1.5mm	C1	CC4577	CAM577

Straight Swivel Adaptor



Thread Size	Swivel	Part No	Pkt No.
M10 x 1.0	C1	CC4615	CAM615
M12 x 1.5	C1	CC4616	CAM616
M14 x 1.5	C1	CC4617	CAM617
M16 x 1.5	C1	CC4618	CAM618
M22 x 1.5	C1	CC4619	CAM619

Tee Adaptor - On Run Swivel



Thread Size	Swivel	Part No	Pkt No.
M12 x 1.5	C1	CC4591	CAM591
M16 x 1.5	C1	CC4592	CAM592

Tee Adaptor - Centre Swivel



Thread Size	Swivel	Part No	Pkt No.
M12 x 1.5	C1	CC4589	CAM589
M16 x 1.5	C1	CC4590	CAM590

Elbow 45 Degree



Thread Size	Swivel	Part No
M16 x 1.5	C1	CC4578

Elbow Adaptor 90 Degree Swivel



Thread Size	Swivel	Part No	Pkt No.
M12 x 1.5	C1	CC4579	CAM579
M16 x 1.5	C1	CC4580	CAM580

Anti Rotation Ring



Size	Part No.
22mm	CC7420

Release Tool



Tube OD	Part No	Pkt No.
6mm	CC7406	CAM7406
8mm	CC7408	CAM7408
10mm	CC7410	CAM7410
12mm	CC7412	CAM7412
15mm	CC7415	CAM7415
16mm	CC7416	CAM7416

Assorted Boxes - Release Tool Kit Part No. CC7400A / Camozzi C1 Kit Part No. MSK812

For a breakdown of all assorted boxes see section 11

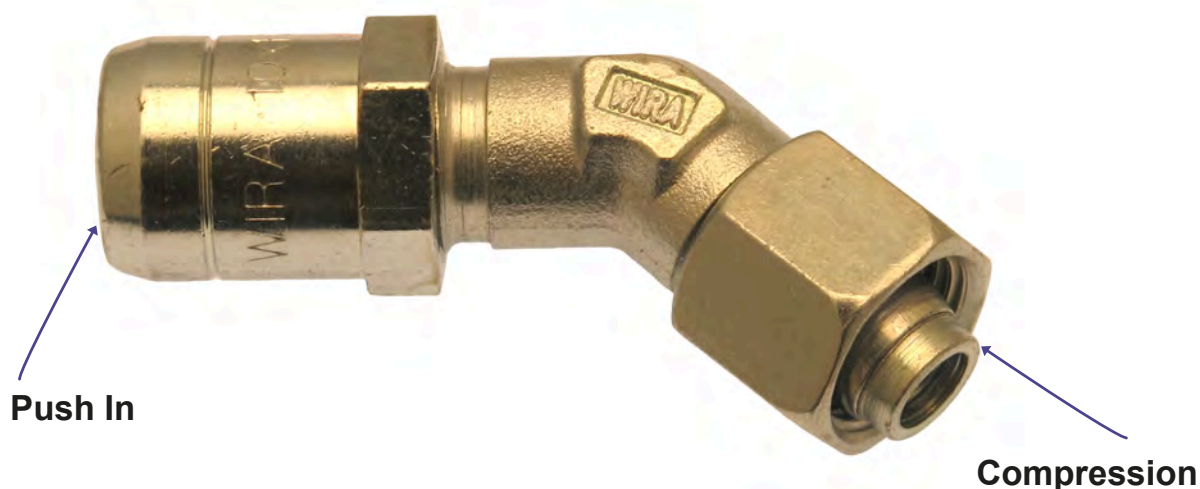

The WIRA push-in fitting is designed to be quick and easy to use, extremely versatile and totally secure. After undergoing strenuous tests, it is one of only a few push-in fittings to have gained the German TUV approval for vehicle braking systems.

EASE OF USE

Supplied by Tube Gear Ltd as complete assemblies, it considerably reduces labour costs by eliminating the need to build an elbow or tee-type connector as well as the time saved in just pushing the tube into the fitting. It can also be disconnected if required.

VERSATILITY

The availability of fifteen metric tube sizes from 6mm to 18mm and the fitting's compatibility with DIN standard W3861 compression form gives endless options of application.

SECURITY

With the tandem seal on the atmosphere side of the tube grip, it ensures that any score marks made during tube fitment cannot affect the seal capabilities. It also prevents any dirt getting into the fitting, thus prolonging its life. The tube grip has two ribs which, because of their depth limitation, cannot cut through the nylon tube but do provide total security of tube retention. Whilst the fitting cannot be released either accidentally or by vandals, it can be undone and re-connected very easily.

ASSEMBLY INSTRUCTIONS FOR PUSH-IN FITTINGS

Connecting the push-in fitting to the main body

The push-in fitting seals onto the body by way of an o-ring and should not be over tightened as this could damage the o-ring. The taper on the tube support acts only as a guide into the body and has no effect on the seal

Tube OD	Torque	Tube OD	Torque	Tube OD	Torque
6 mm	14 nm/10 lbsft	10 mm	22 nm/16 lbsft	15 mm	36 nm/26 lbsft
8 mm	17 nm/12 lbsft	11 mm	30 nm/22 lbsft	16 mm	40 nm/29 lbsft
9 mm	22 nm/16 lbsft	12 mm	30 nm/22 lbsft	18 mm	48 nm/35 lbsft

Connecting the tube to the push-in fitting

As the WIRA push-in fitting has an integral tube support it is essential to ensure that the inside and outside diameters of the nylon tube match those of the fitting.

Mark the depth of insertion of the tube with a suitable marker. This can be done by using the insertion table, as shown, or by placing the end of the tube against the back of the hexagon and marking the tube at the end of the fitting.

Tube OD	Insertion	Tube OD	Insertion	Tube OD	Insertion
6 mm	18.0mm	10 mm	19.5mm	15 mm	20.5mm
8 mm	18.0mm	11 mm	19.5mm	16 mm	20.5mm
9 mm	19.5mm	12 mm	20.5mm	18 mm	22.5mm

Cut the tube squarely ensuring there are no burrs on the inside or outside. Insert the tube into the connector until it comes to a stop against the main body of the coupling. The mark on the tube should be parallel with the end of the connection. Pull the tube to ensure it is locked in.

Disconnecting the push-in end fitting

Unscrew the end fitting from the body with the correct size spanner.

This does not damage either the tube or the components of the end fitting.

Dismantling the push-in fitting

Using the special needle (supplied free of charge) remove the o-ring at the base of the thread. Slide the nut back and remove the tube support. Cut the tube directly behind the tube grip so the grip can be pushed backwards off the tube.

Assembling the push-in fitting

After checking that none of the components are damaged, drop the tube grip into the nut with the taper facing the back of the nut. Place the tube support into the nut and replace the o-ring using the smooth edge of the special needle.

A puncture of the o-ring will not cause a sealing problem.

Tube Gear Limited do not advise that any range of fittings or manufacturers brand are used in conjunction with any other range of fittings or manufacturers brand

All the metric threads are parallel and need a seal when screwed into a port.
 The most popular seal being the combination of thrust & o-ring. Also, the thread in the tube nut is always directly related to the outside diameter of the tube enabling combination fittings to be made. eg. 10mm tube uses M16 x 1.5 thread in the tube nut.

Components / Materials

1. Body according to DIN W 3861 / Steel
2. Nut / Brass
3. Integral Tube Support / Brass
4. O-Ring / Special material
5. Tube Grip / Brass
6. Tandem O-Ring / Special material
7. Lock Nut / Steel
8. Thrust and O-Ring / Brass and Perbunan

Tube OD	Thread
6mm	M12 x 1.5
8mm	M14 x 1.5
9mm	M16 x 1.5
10mm	M16 x 1.5
12mm	M18 x 1.5
15mm	M22 x 1.5
16mm	M22 x 1.5
18mm	M26 x 1.5



Torque Settings

Hexagon Nuts At Integral Thread - All integral threads with Thrust and O ring
 Straight Studs - All integral threads with Thrust and O ring
 Hexagon Nuts At Bulkhead Thread - All integral threads with Thrust and O ring

Thread Size G	Tightening Torque Nm	Tolerance
M10X1	15	+/-10%
M12X1.5	20	+/-10%
M14X1.5	24	+/-10%
M16X1.5	29	+/-10%
M18X1.5	33	+/-10%
M22X1.5	40	+/-10%

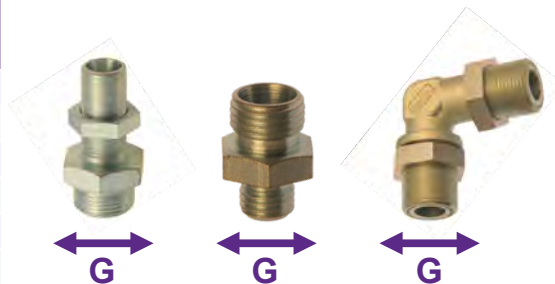

Thread Size G	Tightening Torque Nm	Tolerance
M12X1.5	14	+/-10%
M14X1.5	17	+/-10%
M16X1.5	20	+/-10%
M18X1.5	28	+/-10%
M22X1.5	38	+/-10%
M26X1.5	48	+/-10%

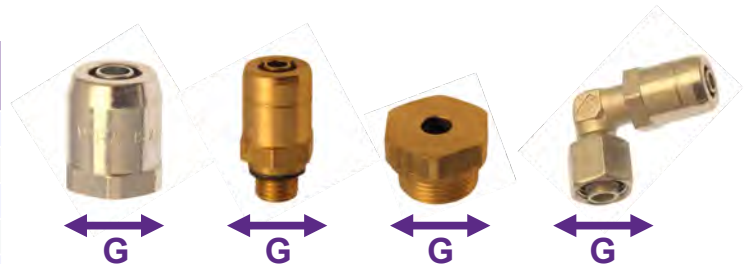

Straight Stud Adaptor - Metric



Tube Size	Thread Size	Part No
6 x 1mm	M10 x 1	7041
6 x 1mm	M12 x 1.5	7042
6 x 1mm	M14 x 1.5	7043
6 x 1mm	M16 x 1.5	7044
6 x 1mm	M22 x 1.5	7045
8 x 1mm	1/4 NPT	7046
8 x 1mm	M10 x 1	7047
9 x 1.5mm	M12 x 1.5	7052
9 x 1.5mm	M16 x 1.5	7053
9 x 1.5mm	M22 x 1.5	7054
10 x 1mm	M22 x 1.5	7062.1
10 x 1.25mm	1/4 NPT	7055
10 x 1.25mm	M10 x 1	7056
10 x 1.25mm	M12 x 1.5	7057
10 x 1.25mm	M14 x 1.5	7058
10 x 1.25mm	M16 x 1.5	7059
10 x 1.25mm	M18 x 1.5	7060
10 x 1.25mm	M22 x 1.5	7062
10 x 1.5mm	M12 x 1.5	7057.5
10 x 1.5mm	M14 x 1.5	7058.5
10 x 1.5mm	M16 x 1.5	7059.5
10 x 1.5mm	M22 x 1.5	7062.5
11 x 1.5mm	M16 x 1.5	7064
12 x 1.5mm	M12 x 1.5	7067
12 x 1.5mm	M14 x 1.5	7068
12 x 1.5mm	M16 x 1.5	7069
12 x 1.5mm	M18 x 1.5	7070
12 x 1.5mm	M22 x 1.5	7071
15 x 1.5mm	M16 x 1.5	7076
15 x 1.5mm	M22 x 1.5	7077
15 x 1.5mm	M26 x 1.5	7577
15 x 2mm	M16 x 1.5	7076.2
16 x 2mm	M22 x 1.5	7078

Straight Stud Adaptor - Metric



Tube Size	Thread Size	Part No
8 x 1mm	M12 x 1.5	7048
8 x 1mm	M14 x 1.5	7049

Straight Stud Adaptor - Metric



Tube Size	Thread Size	Part No
8 x 1mm	M16 x 1.5	7050
8 x 1mm	M22 x 1.5	7051

Brass Straight Stud Adaptor - Metric



Tube Size	Thread Size	Part No
8 x 1mm	M12 x 1.5	8048
8 x 1mm	M14 x 1.5	8049

Brass Straight Stud Adaptor - Metric



Tube Size	Thread Size	Part No
15 x 1.5mm	M22 x 1.5	8077
18 x 2mm	M22 x 1.5	8079

Brass Straight Stud Adaptor - Metric



Tube Size	Thread Size	Part No
8 x 1mm	M16 x 1.5	8050
8 x 1mm	M22 x 1.5	8051
12 x 1.5mm	M22 x 1.5	8071

Brass Straight Stud Adaptor - Metric



Tube Size	Thread Size	Part No
10 x 1.25mm	M12 x 1.5	8057
10 x 1.25mm	M16 x 1.5	8059
12 x 1.5mm	M16 x 1.5	8069

Assorted Box - Wira push in range Part No. MSK703

For a breakdown of all assorted boxes see section 11

Wira

Push In End Fitting



Tube Size	Thread Size	Part No.
* 6 x 1mm	M12 x 1.5	7030
* 8 x 1mm	M14 x 1.5	7031
* 8 x 1mm	M18 x 1.5	7028
8 x 1.5mm	M14 x 1.5	7031.5
9 x 1.5mm	M16 x 1.5	7032
10 x 1mm	M16 x 1.5	7033.1
* 10 x 1.25mm	M16 x 1.5	7033
10 x 1mm	M18 x 1.5	7029
10 x 1.5mm	M16 x 1.5	7033.5
* 11 x 1.5mm	M18 x 1.5	7034
* 12 x 1.5mm	M18 x 1.5	7035
* 15 x 1.5mm	M22 x 1.5	7037
15 x 2mm	M22 x 1.5	7037.2
* 16 x 2mm	M22 x 1.5	7038
* 18 x 2mm	M26 x 1.5	7039

* Denotes Standard Tube Sizes
Assorted Box Part No. 7030A
For a breakdown of all assorted
boxes see section 11

Straight Bulkhead Connector



Tube Size	Thread Size	Part No
10 x 1.25mm	M22 x 1.5	7131

Straight Bulkhead Connector



Tube Size	Thread Size	Part No
12 x 1.5mm	M18 x 1.5	7148SE

Straight Bulkhead Connector



Tube Size	Thread Size	Part No
6 x 1mm	M12 x 1.5	7143
8 x 1mm	M14 x 1.5	7144
10 x 1.25mm	M16 x 1.5	7146
12 x 1.5mm	M18 x 1.5	7148

Exhaust Silencer



Thread Size	Part No
M12 x 1.5	7993
M16 x 1.5	7995
1/4	7996
1/8	7997

Straight Bulkhead Connector



Tube Size	Thread Size	Part No
8 x 1mm	M22 x 1.5	7132
10 x 1mm	M22 x 1.5	7136.1
10 x 1.25mm	M16 x 1.5	7135
10 x 1.25mm	M18 x 1.5	7455
10 x 1.25mm	M22 x 1.5	7136
12 x 1.5mm	M16 x 1.5	7138
12 x 1.5mm	M22 x 1.5	7139

Straight Stem Reducer



Tube Size	Stem OD	Thread Size	Part No
6 x 1mm	8mm	M14 x 1.5	7325
6 x 1mm	10mm	M16 x 1.5	7326
8 x 1mm	10mm	M16 x 1.5	7327
8 x 1mm	12mm	M18 x 1.5	7329
10 x 1.25mm	12mm	M18 x 1.5	7331

Straight Connector



Tube Size	Part No.
6 x 1mm	7110
8 x 1mm	7112
9 x 1.5mm	7113
10 x 1mm	7114.1
10 x 1.25mm	7114
10 x 1.5mm	7114.5
11 x 1.5mm	7115
12 x 1.5mm	7116
15 x 1.5mm	7117
15 x 2mm	7117.2
16 x 2mm	7118
18 x 2mm	7119

Straight Un-equal Connector



Tube Size	Tube Size	Part No.
8 x 1mm	6 x 1mm	7120
10 x 1.25mm	6 x 1mm	7121
10 x 1.25mm	8 x 1mm	7122
12 x 1.5mm	6 x 1mm	7123
12 x 1.5mm	8 x 1mm	7124
12 x 1.5mm	10 x 1.25mm	7125

Straight Female Stud



Tube Size	Thread Size	Part No.
8 x 1mm	M22 x 1.5	7082
10 x 1.25mm	M22 x 1.5	7086
12 x 1.5mm	M22 x 1.5	7090

45 Degree Elbow



Tube Size	Thread Size	Part No.
10 x 1.25mm	M16 x 1.5	7174
12 x 1.5mm	M16 x 1.5	7264

45 Degree Elbow



Tube Size	Thread Size	Part No.
12 x 1.5mm	M18 x 1.5	7339

45 Degree Elbow



Thread A	Thread B	Part No.
M16 x 1.5	M18 x 1.5	7981T

Equal Bulkhead Elbow 90 Degree



Tube Size	Thread Size	Part No.
8 x 1mm	M14 x 1.5	7182
10 x 1.25mm	M16 x 1.5	7184
12 x 1.5mm	M18 x 1.5	7186

Bulkhead Elbow 90 Degree



Tube Size	Thread Size	Part No.
8 x 1mm	M14 x 1.5	7152
10 x 1.25mm	M16 x 1.5	7153
12 x 1.5mm	M18 x 1.5	7187

Wira

Elbow Stud 90 Degree



Tube Size	Thread Size	Part No
6 x 1mm	M10 x 1	7155
6 x 1mm	M12 x 1.5	7156
6 x 1mm	M14 x 1.5	7157
6 x 1mm	M16 x 1.5	7158
6 x 1mm	M22 x 1.5	7159
8 x 1mm	M12 x 1.5	7160
8 x 1mm	M14 x 1.5	7161
8 x 1mm	M16 x 1.5	7162
8 x 1mm	M22 x 1.5	7163
9 x 1.5mm	M12 x 1.5	7164
9 x 1.5mm	M16 x 1.5	7165
10 x 1mm	M16 x 1.5	7170.1
10 x 1.25mm	1/4 NPT	7167
10 x 1.25mm	M12 x 1.5	7168
10 x 1.25mm	M14 x 1.5	7169
10 x 1.25mm	M16 x 1.5	7170
10 x 1.25mm	M22 x 1.5	7171
10 x 1.5mm	M12 x 1.5	7168.5
10 x 1.5mm	M16 x 1.5	7170.5
11 x 1.5mm	M16 x 1.5	7172
11 x 1.5mm	M22 x 1.5	7173
12 x 1.5mm	M16 x 1.5	7175
12 x 1.5mm	M22 x 1.5	7176
15 x 1.5mm	M16 x 1.5	7177
15 x 1.5mm	M22 x 1.5	7178
15 x 2mm	M22 x 1.5	7178.2
16 x 2mm	M22 x 1.5	7179
18 x 2mm	M22 x 1.5	7180

Side Stud Tee



Tube Size	Thread Size	Part No.
10 x 1.25mm	M16 x 1.5	7263

Bulkhead Tee Connector



Tube Size	Thread Size	Part No.
10 x 1.25mm	M16 x 1.5	7268

Stud Cross



Tube Size	Thread Size	Part No
10 x 1.25mm	M12 x 1.5	7376
10 x 1.25mm	M22 x 1.5	7427

Side Stud Tee



Tube Size	Thread Size	Hose ID	Part No.
10 x 1.25mm	M16 x 1.5	13mm	7426

Tee Connector



Tube Size	Part No.
6 x 1mm	7275
8 x 1mm	7276
10 x 1.25mm	7278
12 x 1.5mm	7280
15 x 1.5mm	7281
16 x 2mm	7282
18 x 2mm	7283

Side Stem Tee



Tube Size	Stem OD	Thread Size	Part No.
10 x 1.25mm	10mm	M16 x 1.5	7439

Un-Equal Side Stud Tee



Tube A Size	Tube B Size	Thread Size	Part No.
12 x 1.5mm	8 x 1mm	M16 x 1.5	7258
12 x 1.5mm	8 x 1mm	M22 x 1.5	7259

Branch Stud Tee - Equal



Tube Size	Thread Size	Part No.	Brass Part No.
6 x 1mm	M12 x 1.5	7210	
6 x 1mm	M16 x 1.5	7211	
8 x 1mm	M12 x 1.5	7213	
8 x 1mm	M16 x 1.5	7214	
8 x 1mm	M22 x 1.5	7215	8215B
10 x 1.25mm	M12 x 1.5	7218	
10 x 1.25mm	M16 x 1.5	7220	
10 x 1.25mm	M22 x 1.5	7221	
12 x 1.5mm	M16 x 1.5	7224	
12 x 1.5mm	M22 x 1.5	7225	
15 x 1.5mm	M22 x 1.5	7226	

Side Stem Tee



Tube Size	Stem OD	Thread Size	Part No.
8 x 1mm	8mm	M14 x 1.5	7351
10 x 1.25mm	10mm	M16 x 1.5	7353
12 x 1.5mm	12mm	M18 x 1.5	7355

Branch Stem Tee Connector



Tube Size	Stem OD	Thread Size	Part No.
8 x 1mm	8mm	M14 x 1.5	7366
10 x 1.25mm	10mm	M16 x 1.5	7368
12 x 1.5mm	12mm	M18 x 1.5	7370

Side Stud Tee



Tube Size	Thread Size	Part No.
6 x 1mm	M12 x 1.5	7233
8 x 1mm	M16 x 1.5	7239
10 x 1.25mm	M12 x 1.5	7244
10 x 1.25mm	M14 x 1.5	7291
10 x 1.25mm	M16 x 1.5	7245
10 x 1.25mm	M22 x 1.5	7246
12 x 1.5mm	M16 x 1.5	7249
12 x 1.5mm	M22 x 1.5	7250

Stem Elbow 90 Degree



Tube Size	Stem OD	Thread Size	Part No.
6 x 1mm	6mm	M12 x 1.5	7340
8 x 1mm	6mm	M12 x 1.5	7342
8 x 1mm	8mm	M14 x 1.5	7341
10 x 1.25mm	10mm	M16 x 1.5	7343
12 x 1.5mm	12mm	M18 x 1.5	7345
15 x 1.5mm	15mm	M22 x 1.5	7347
18 x 2mm	18mm	M26 x 1.5	7349

Un-Equal Tee Connector



Tube A Size	Tube B Size	Tube C Size	Part No.
9 x 1.5mm	8 x 1mm	9 x 1.5mm	7284
10 x 1.25mm	6 x 1mm	10 x 1.25mm	7285
10 x 1.25mm	8 x 1mm	10 x 1.25mm	7286
12 x 1.5mm	8 x 1mm	12 x 1.5mm	7287
12 x 1.5mm	10 x 1.25mm	12 x 1.5mm	7288

Stem Cross Adaptor



Tube Size	Stem OD	Thread Size	Part No
10 x 1.25mm	10mm	M16 x 1.5	7375

Side Stud Tee Test Point



Tube Size	Thread Size	Part No
8 x 1mm	M16 x 1.5	7387
10 x 1.25mm	M16 x 1.5	7390
12 x 1.5mm	M16 x 1.5	7392
12 x 1.5mm	M22 x 1.5	7393

Side Stud Tee Test Point



Tube Size	Thread Size	Part No
8 x 1mm	M16 x 1.5	7380
8 x 1mm	M22 x 1.5	7381
10 x 1.25mm	M12 x 1.5	7382
10 x 1.25mm	M16 x 1.5	7383
10 x 1.25mm	M22 x 1.5	7384
12 x 1.5mm	M16 x 1.5	7385
12 x 1.5mm	M22 x 1.5	7386

Tee Test Point



Tube Size	Part No
8 x 1mm	7420
10 x 1.25mm	7422
12 x 1.5mm	7424

Branch Stud Tee Test Point



Tube Size	Thread Size	Part No
10 x 1.25mm	M12 x 1.5	7378
10 x 1.25mm	M16 x 1.5	7396
10 x 1.25mm	M22 x 1.5	7397
12 x 1.5mm	M16 x 1.5	7445
12 x 1.5mm	M22 x 1.5	7398

Test Point Bulkhead



Tube Size	Thread Size	Part No
6 x 1mm	M12 x 1.5	7441

Male Tee



Thread Size	Part No	Part No with T&O
M22 x 1.5	7887G	7887T

Hose Tail Tee



Hose ID	Thread Size	Part No	Part No with T&O
13 mm	M22 x 1.5	7828G	7828T

Bulkhead Elbow



Thread Size	Part No	C/W T&O
M22 x 1.5	7850G	7850T

Straight Bulkhead Adaptor



Thread A	Thread B	Part No	C/W T&O	Pkt No.
M16 x 1.5	M16 x 1.5	7896G	7896T	
M16 x 1.5	M22 x 1.5	7928G	7928T	
M22 x 1.5	M12 x 1.5	7961	7961T	
M22 x 1.5	M14 x 1.5	7740G	7740T	
M22 x 1.5	M16 x 1.5	7741G	7741T	
M22 x 1.5	M18 x 1.5	7760G		
M22 x 1.5	M22 x 1.5	7742G	7742T	MAB078
1/2 BSP	M22 x 1.5	7755G		MAB082

Bulkhead Connector



Thread A	Thread B	Thread C	Part No
M16 x 1.5	M16 x 1.5	M10 x 1	7430
M16 x 1.5	M22 x 1.5	M10 x 1	7494
M22 x 1.5	M16 x 1.5	M16 x 1.5	7431
M22 x 1.5	M22 x 1.5	M16 x 1.5	8742B
M22 x 1.5	M22 x 1.5	M16 x 1.5	7499



The Norgren FleetFit Push-In Fittings are a range of dedicated fittings designed to reduce the installation time to a minimum whilst ensuring a secure seal on vehicle air braking and suspension system.

Applications

Used by many truck manufacturers and in various applications

The Fleetfit range has been fitted as original equipment to vehicles throughout the world since 1982 and now have full TUV approval as well as conforming to the following standards:

DOT FMUSSI06, SAE J1131, DIN 74324

Technical Data

Operating Medium: Compressed Air

Maximum Working Pressure: 0 to 10 Bar

Working Temperature: -40°C to 100°C.

Tubing: DIN 74324, SAE J844

Tube Connection/Disconnection

Tube Gear Limited do not advise that any range of fittings or manufacturers brand are used in conjunction with any other range of fittings or manufacturers brand



Straight Connector



Tube OD	Part No.	Pkt No.
6mm	6502	PIF302
8mm	6504	PIF304
9mm	6505	PIF305
10mm	6506	PIF306
11mm	6507	PIF307
12mm	6508	PIF308
14mm	6510	PIF310
15mm	6511	PIF311
16mm	6512	PIF312

Straight Reducer Connector



Tube OD	Tube OD	Part No.
8mm	6mm	6513
10mm	6mm	6514
10mm	8mm	6515
12mm	10mm	6518

Unequal Tee Connector



Tube OD			Part No
A	B	C	
10mm	10mm	6mm	6528
12mm	12mm	6mm	6530
12mm	12mm	10mm	6524

Elbow Connector



Tube OD	Part No.	Pkt No.
6mm	6533	PIF333
8mm	6535	PIF335
10mm	6537	PIF337
12mm	6539	PIF339
15mm	6542	
16mm	6543	PIF343

Equal Tee Connector



Tube OD	Part No.	Pkt No.
6mm	6517	PIF317
8mm	6519	PIF319
9mm	6520	
10mm	6521	PIF321
11mm	6522	
12mm	6523	PIF323
15mm	6526	
16mm	6527	PIF327

Branch Stud Tee Adaptor



Tube OD	Thread Size	Part No	Pkt No
10mm	M16 x 1.5	6638	PIF438
10mm	M22 x 1.5	6639	PIF439
12mm	M16 x 1.5	6644	PIF444
12mm	M22 x 1.5	6645	PIF445

Bulkhead Stud Coupling



Tube OD	Thread Size	Part No	Pkt No
10mm	M22 x 1.5	6813	PIF613
12mm	M22 x 1.5	6816	PIF616

Side Stud Tee Adaptor



Thread Size	Part No
M16 x 1.5	6826
M22 x 1.5	6827

Branch Stud Tee Adaptor



Thread Size	Part No
M12 x 1.5	6821
M16 x 1.5	6822
M22 x 1.5	6823

Elbow Stud 90 Degree



Tube OD	Thread Size	Part No	Pkt No
6mm	M12 x 1.5	6602	PIF402
6mm	M16 x 1.5	6703	
6mm	M22 x 1.5	6609	
8mm	M12 x 1.5	6604	PIF404
8mm	M14 x 1.5	6607	
8mm	M16 x 1.5	6605	PIF405
8mm	M22 x 1.5	6606	PIF406
10mm	M10 x 1	6601	
10mm	M12 x 1.5	6610	PIF410
10mm	M14 x 1.5	6608	
10mm	M16 x 1.5	6613	PIF413
10mm	M22 x 1.5	6614	PIF414
12mm	M16 x 1.5	6619	PIF419
12mm	M22 x 1.5	6620	PIF420
16mm	M16 x 1.5	6625	PIF425
16mm	M22 x 1.5	6626	PIF426

Straight Stud



Tube OD	Thread Size	Part No.	Pkt No.
6mm	M10 x 1	6564	PIF364
6mm	M12 x 1.5	6565	PIF365
6mm	M14 x 1.5	6566	PIF366
6mm	M16 x 1.5	6567	PIF367
6mm	M22 x 1.5	6568	PIF368
8mm	M10 x 1	6569	PIF369
8mm	M12 x 1.5	6570	PIF370
8mm	M14 x 1.5	6571	PIF371
8mm	M16 x 1.5	6572	PIF372
8mm	M22 x 1.5	6573	PIF373
10mm	M10 x 1	6576	PIF376
10mm	M12 x 1.5	6577	PIF377
10mm	M14 x 1.5	6578	PIF378
10mm	M16 x 1.5	6579	PIF379
10mm	M22 x 1.5	6580	PIF380
12mm	M12 x 1.5	6584	PIF384
12mm	M14 x 1.5	6585	PIF385
12mm	M16 x 1.5	6586	PIF386
12mm	M22 x 1.5	6587	PIF387
15mm	M22 x 1.5	6594	PIF394
16mm	M16 x 1.5	6595	PIF395
16mm	M22 x 1.5	6596	PIF396

Elbow Stud



Tube OD	Thread Size	Part No.	Pkt No.
6mm	1/8 BSP	6786	PIF586
6mm	1/4 BSP	6790	PIF590
8mm	1/8 BSP	6787	PIF587
8mm	1/4 BSP	6791	PIF591
8mm	3/8 BSP	6797	
10mm	1/4 BSP	6792	PIF592
10mm	3/8 BSP	6799	PIF599
10mm	1/2 BSP	6805	PIF605
12mm	1/4 BSP	6794	
12mm	3/8 BSP	6801	PIF601
12mm	1/2 BSP	6807	

Elbow Stud 45 Degree



Tube OD	Thread Size	Part No
10mm	M16 x 1.5	6711
12mm	M16 x 1.5	6650

Swivel Elbow Stud 90 Degree



Tube OD	Thread Size	Part No
6mm	M16 x 1.5	6603
8mm	M16 x 1.5	6611

Straight Stud NPT Thread



Tube OD	Thread Size	Part No.
6mm	1/8 NPT	6755NPT
6mm	1/4 NPT	6759NPT
8mm	1/8 NPT	6756NPT
8mm	1/4 NPT	6760NPT
10mm	1/4 NPT	6762NPT
10mm	3/8 NPT	6764NPT
10mm	1/2 NPT	6767NPT
12mm	1/4 NPT	6763NPT
12mm	3/8 NPT	6766NPT
12mm	1/2 NPT	6768NPT
16mm	3/8 NPT	6769NPT
16mm	1/2 NPT	6765NPT

Straight Stud



Tube OD	Thread Size	Part No.	Pkt No.
6mm	1/8 BSP	6755	PIF555
6mm	1/4 BSP	6759	PIF559
8mm	1/8 BSP	6756	PIF556
8mm	1/4 BSP	6760	PIF560
10mm	1/8 BSP	6761	PIF561
10mm	1/4 BSP	6762	PIF562
10mm	3/8 BSP	6764	PIF564
10mm	1/2 BSP	6767	PIF567
12mm	1/4 BSP	6763	PIF563
12mm	3/8 BSP	6766	PIF566
12mm	1/2 BSP	6768	PIF568

Elbow Stud - NPT Thread



Tube OD	Thread Size	Part No.
6mm	1/8 NPT	6786NPT
6mm	1/4 NPT	6790NPT
8mm	1/4 NPT	6791NPT
8mm	3/8 NPT	6797NPT
10mm	1/4 NPT	6792NPT
10mm	3/8 NPT	6799NPT
12mm	1/4 NPT	6794NPT
12mm	3/8 NPT	6801NPT
12mm	1/2 NPT	6807NPT
16mm	3/8 NPT	6809NPT

Bulkhead Connector



Tube OD	Thread Size	Part No.
6mm	M15 x 1	6549
8mm	M18 x 1.5	6551
10mm	M20 x 1.5	6553
12mm	M24 x 1.5	6555

Maxi-stor Box



Description	Part No.
Norgren fleet fit push-in	MSK650

For a breakdown of all assorted boxes see section 11

Standard Assorted Box

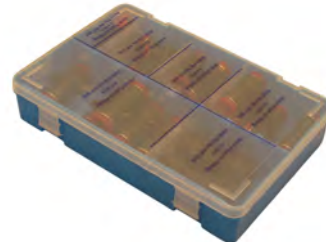

Description	Part No.
Brass push in straights	6500A
Brass push in straights	6500M
Brass push in straights	6500P
Brass push in straight studs	6600A

Norgren Fleetfit Fittings - For Imperial Tube

Elbow Stud



Tube OD	Thread Size	Part No.	Pkt No.
1/4	1/8 BSP	6720	PIF520
1/4	1/4 BSP	6723	PIF523
3/8	1/4 BSP	6726	PIF526
3/8	3/8 BSP	6729	PIF529
3/8	1/2 BSP	6730	
1/2	1/4 BSP	6727	PIF527
1/2	3/8 BSP	6728	
1/2	1/2 BSP	6731	PIF531

Elbow Stud NPT



Tube OD	Thread Size	Part No.
1/4	1/8 NPT	6720NPT
1/4	1/4 NPT	6723NPT
3/8	1/4 NPT	6726NPT
3/8	3/8 NPT	6729NPT
1/2	1/4 NPT	6727NPT
1/2	3/8 NPT	6728NPT
1/2	1/2 NPT	6731NPT
5/8	3/8 NPT	6733NPT

Straight Stud NPT



Tube OD	Thread Size	Part No.
1/4	1/8 NPT	6701NPT
1/4	1/4 NPT	6705NPT
3/8	1/4 NPT	6707NPT
3/8	3/8 NPT	6712NPT
3/8	1/2 NPT	6714NPT
1/2	1/4 NPT	6708NPT
1/2	3/8 NPT	6713NPT
1/2	1/2 NPT	6715NPT
5/8	1/2 NPT	6716NPT

Straight Stud



Tube OD	Thread Size	Part No.	Pkt No.
1/4	1/8 BSP	6701	PIF501
1/4	1/4 BSP	6705	PIF505
3/8	1/8 BSP	6706	
3/8	1/4 BSP	6707	PIF507
3/8	3/8 BSP	6712	PIF512
3/8	1/2 BSP	6714	
1/2	1/4 BSP	6708	
1/2	3/8 BSP	6713	
1/2	1/2 BSP	6715	

Straight Connector



Tube OD	Part No.	Pkt No.
1/4	6665	PIF465
3/8	6667	PIF467
1/2	6668	
5/8	6669	

Equal Tee Connector



Tube OD	Part No.
1/4	6675
3/8	6677
1/2	6678

Elbow Connector



Tube OD	Part No.
1/4	6684
3/8	6686
1/2	6687

Straight Stud



Tube OD	Thread Size	Part No.	Pkt No.
1/4	M10 x 1	6770	
1/4	M12 x 1.5	6771	
1/4	M16 x 1.5	6772	PIF572
3/8	M16 x 1.5	6773	PIF573
3/8	M22 x 1.5	6774	
1/2	M16 x 1.5	6775	PIF575
1/2	M22 x 1.5	6776	
5/8	M16 x 1.5	6777	

Straight Bulkhead Connector



Tube OD	Thread Size	Part No.
3/8	M20 x 1.5	6694
1/2	M24 x 1.5	6695

Straight Connector

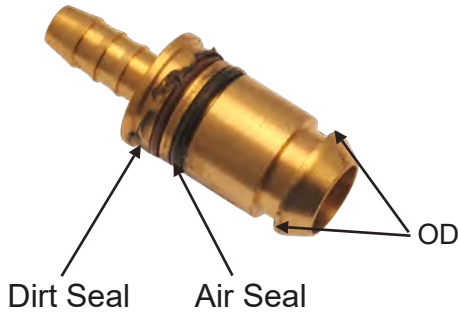

Male Nut



Clip



Rubber Seal



The 230 system is used with the following tube sizes 6 x 1, 8 x 1, 12 x 1.5 & 16 x 2.

Main Features of Identification

This product range splits into two main types, type NG 8 and type NG 12. To identify the different types measure ID or OD and refer to table below:-

Type	OD	ID
NG8	9.4mm	9.4mm
NG12	14.9mm	14.9mm

Original equipment fitment on most Mercedes after 1980 and on most DAF's after 1995. Also fitted to MAN 2000 range of vehicles.

Port Adaptor - Short Thread with O Ring



Thread Size	Type	Part No	Pkt No
M16 x 1.5	NG8	4706	VOS706
M22 x 1.5	NG12	4714	VOS714

Straight Connector



Tube Size	Type	Part No
8 x 1	NG 8	4772

Assembly Unit



Tube Size	Thread Size	Part No
6 x 1	M10 x 1	4778

Port Adaptor - Long Thread with O Ring



Thread Size	Type	Part No	Pkt No
M16 x 1.5	NG12	4712	VOS712

Tee Adaptor



Tube Size	Type	Part No
12 x 1.5	NG12	4776

Tee Adaptor



Tube Size	Type	Part No
12 x 1.5	NG12	4753

Straight Connector



Tube Size	Type	Part No	Pkt No
6 x 1	NG8	4740	
8 x 1	NG8	4741	
6 x 1	NG12	4742	
8 x 1	NG12	4743	
12 x 1.5	NG12	4744	VOS744

Elbow



Tube Size	Type	Part No	Pkt No
6 x 1	NG8	4746	
8 x 1	NG8	4747	VOS747
6 x 1	NG12	4748	
8 x 1	NG12	4749	VOS749
12 x 1.5	NG12	4750	VOS750
16 x 2	NG12	4751	

Male Nut



Thread	Type	Part No	Pkt No
M16 x 1.5	NG8	4702	VOS702
M22 x 1.5	NG12	4703	VOS703

Repair Kit



Type	Part No	Pkt No
NG8	4720	VOS720
NG12	4721	VOS721

Clip



Type	Part No
NG8	4700
NG12	4701

Spring Element



Type	Part No
NG8	4704
NG12	4705

Maxi-stor Box



Description	Part No
Contains all popular 230 components	MSK470

For a breakdown of all assorted boxes see section 11

Assembly Tool Gripping Pliers



Description	Part No
For the assembly of 230 and 232 fittings	4992

Push in Air Brake

Voss 230



Part No.	Type	Can be used to make
4939	0233264200	0233264249
		0233314249
		5232820249
		5232820270
		5232820500
		5232820570



Part No.	Type	Can be used to make
4940	0233304200	0233304249
		0233324249
		0233334200
		5232820449
		5232820470
		5232820749



Part No.	Type	Can be used to make
4942	0228744271	5232811000
		5232811070



Part No.	Type	Can be used to make
4941	7000117400 replaces 0830494200	0233124200
		0230494200
		5232820300

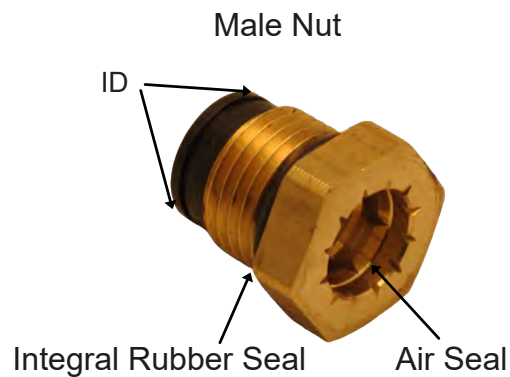
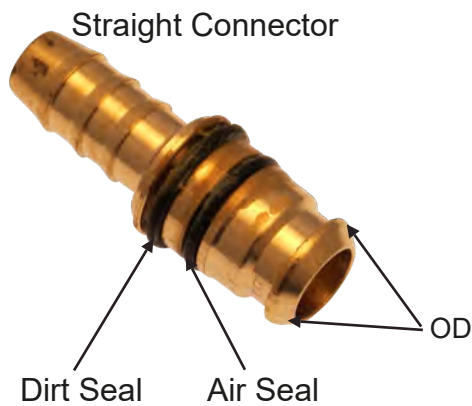

The 232 system is used with the following tube sizes 6 x 1, 8 x 1, 12 x 1.5 & 16 x 2.

Main Features of Identification

This product range splits into two main types, type NG 8 and type NG 12. To identify the different types measure ID or OD and refer to table below:-

Type	OD	ID
NG8	9.1mm	9.1mm
NG12	14.6mm	14.6mm

Original equipment fitment on most Mercedes after 1980 and on most DAF's after 1995. Also fitted to MAN 2000 range of vehicles.

Maxi-stor Box



Description	Part No
Contains all popular 232 components	MSK475

For a breakdown of all assorted boxes see section 11

Assembly Tool Gripping Pliers



Description	Part No
For the assembly of 230 and 232 fittings	4992

Straight Connector



Tube Size	Type	Part No
8 x 1	NG 8	4780

Tee Adaptor



Tube Size	Type	Part No
12 x 1.5	NG 12	4771

Dirt Seal O Ring



Type	Size	Part No
NG8	7.5 x 2	4730
NG12	12 x 2	4731

Air Seal O Ring



Type	Size	Part No
NG8	7 x 1.5	4725
NG12	12 x 1.6	4726

Straight Connector



Tube Size	Type	Part No	Pkt No
6 x 1	NG8	4754	
8 x 1	NG8	4755	VOS755
6 x 1	NG12	4756	
8 x 1	NG12	4757	VOS757
12 x 1.5	NG12	4758	VOS758

Male Nut



Thread Size	Type	Part No	Pkt No
M16 x 1.5	NG8	4759	VOS759
M22 x 1.5	NG12	4760	VOS760

Straight Connector



Thread Size	Type	Part No	Pkt No
M16 x 1.5	NG8	4768	
M16 x 1.5	NG12	4769	VOS769
M22 x 1.5	NG12	4770	VOS770

These ports adaptors are used to convert standard ported air brake equipment to be used with 232 range Voss fittings. They are supplied complete ready to accept the male connector

Elbow



Tube Size	Type	Part No	Pkt No
6 x 1	NG8	4761	VOS761
8 x 1	NG8	4762	VOS762
6 x 1	NG12	4763	VOS763
8 x 1	NG12	4764	VOS764
12 x 1.5	NG12	4765	VOS765
16 x 2	NG12	4766	VOS766

Page 2.2 - 2.5

Components

Tube Gear range of components to compliment Tube Gears range of Wira Fittings

Page 2.8

Port Extensions

These port extensions are designed to allow the nylon brake pipe to be indirectly connected to the spring brake chamber. On many SAF axle applications using the WIRA extensions, allows the brake chamber ports to be extended past the cross member.

Page 2.10 - 2.15

Wira Fittings

The Tube Gear range of steel compression fittings are designed specifically for vehicle pneumatic systems, including air-brake suspension, they have been used as standard fittings in the UK since 1980

Page 2.17 - 2.19

C & CA Couplings

C Couplings are designed to eliminate the problems of mismatched components with a one piece construction that cannot be dismantled, Improved airflow with an increased Valve Lift, Improved life span with increased Surface Protection, Colour Coded for safety

Page 2.21

Manifolds

Tube Gears Range of Brass and Plastic Multi-Ported Manifolds

Page 2.6 - 2.7

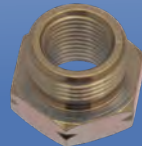
Adaptors

Tube Gear's extensive range of Thread Adaptors for Metric and Imperial Threads

Page 2.8 - 2.9

Hose Tails

Tube gears range of hose tails for use with trailer airbrake hoses.

Page 2.16

Test Points

We have a large range of test points in metric and imperial sizes, ideal for a range of different applications, like our air tank range in section 10

Page 2.20

Palm Couplings

Palm couplings are available in both red and yellow / supply and emergency options, light weight and self sealing versions in metric and imperial sizes

ASSEMBLY INSTRUCTIONS FOR COUPLINGS AND NYLON TUBING

1. Cut the tube squarely and lightly push the tube support into the tube until its shoulder is flat against the end
2. Slide the nut and cutting ring over the tube and push the tube-end firmly against the seat face in the body
3. Screw nut on until it's finger tight and using a spanner tighten the nut another 1 1/2 turns
4. Release the nut and check the cutting ring has penetrated the outer wall of the tube and created a visible collar
5. Re-assemble the fitting as normal using a spanner

Tube OD	Thread
6mm	M12 x 1.5
8mm	M14 x 1.5
9mm	M16 x 1.5
10mm	M16 x 1.5
12mm	M18 x 1.5
15mm	M22 x 1.5
16mm	M22 x 1.5
18mm	M26 x 1.5

**CAUTION : DO NOT OVERTIGHTEN AS THIS CAN
DAMAGE THE TUBE**

USEFUL INFORMATION

The Tube Gear range of steel compression fittings are designed specifically for vehicle pneumatic systems, including air-brake suspension, where they have been used as the standard fitting in the UK since about 1980. Commonly known as the DIN standard 2353 range, all of the fittings conform to their relevant DIN standard in terms of material, shape and burst pressure and are supplied assembled with a single bite-ring conforming to DIN 3861 (The double bite-ring is designed for use on hydraulic steel tube).

Corrosion protection of Wira steel fittings is in accordance with VDA 233-101 Zn-p-v-Si. The coating is Cr free and compliant with ELV (End of Life Vehicles) Regulations

Components

Blanking Plug

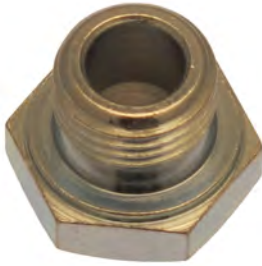

Thread Size	Part No	Part No with T&O	Pkt No
M10 x 1	7620	7620T	8620
M12 x 1.5	7621	7621T	8621
M14 x 1.5	7624	7624T	
M16 x 1.5	7622	7622T	8622
M18 x 1.5	7625	7625T	
M22 x 1.5	7623	7623T	8623

7620T is available with copper washer part no. 7620C

Blanking Plug Hex Socket Head



Thread Size	Part No
M12 x 1.5	7621ST
M16 x 1.5	7622ST
M22 x 1.5	7623ST

Lock Nut



Thread	Part No	Pkt No
M12 x 1.5	7671G	8671
M14 x 1.5	7672G	8672
M16 x 1.5	7673G	8673
M18 x 1.5	7674G	8674
M22 x 1.5	7675G	8675
M26 x 1.5	7676G	

Chrome Plated Brass Shut Off Tap



Thread Size	Part No
1/4 BSP	0137
3/8 BSP	0138
1/2 BSP	0132
1/2 BSP	0132G
3/4 BSP	0139
1 1/4 BSP	0141

Part No. 0132G Gas Approved With Yellow Handle

Tube Nut



Tube OD	Part No	Pkt No
6mm	7680G	8680
8mm	7681G	8681
10mm	7682G	8682
12mm	7683G	8683
15mm	7684G	
16mm	7685G	8685
18mm	7686G	

Remote Drain Tap



Thread Size	Part No	Part No with T&O	Pkt No
M22 x 1.5	7628	7628T	8628
M22 x 1.5		7629T	

7629T comes with 6ft cable

Drain Tap



Thread Size	Part No
1/4 BSP	0135
3/8 BSP	0142
1/2 BSP	0143

Thread Sealant



Part No.	Description
0302	Thread Sealant

This handy concertina bottle contains 50ml of liquid sealant and is designed to be used to replace the use of PTFE tape etc. The liquid produces an instant flexible seal on threads and joints and can be used to fill a maximum gap of 0.15mm.

Drain Taps & Sealing Rings

Chrome Drain Tap Male - Female



Type	Part No
1/4 BSP	0134

Chrome Drain Tap Female - Female



Type	Part No
1/8 BSP	0144

Butterfly Drain Tap



Type	Part No
1/4 BSP	0136

Thrust & O Rings



Thread Size	Thrust Ring Part No.	O Ring Part No.	Thrust & O Ring Pkt No.
M10	7640	7646	8640
M12	7641	7647	8641
M14	7642	7648	8642
M16	7643	7649	8643
M18	7644	7650	8644
M22	7645	7651	8645
M26	7592	7593	

Assorted Box Part No. 7638

O Rings



ID	OD	Material	Part No.
1/2	3/4	Nitrile	4727
9.5mm	12.5mm	Nitrile	7661
21.6mm	23mm	Nitrile	7662

Assorted Box of sealing rings Part No. MSK764
C/W Aluminium, Copper Bonded & Thrust & O Rings
For a breakdown of all assorted boxes
see section 11

Copper Sealing Ring



Thread Size	Part No.	Pkt No.
M10	7652	8652
M12	7653	8653
M14	7654	8654
M16	7655	8655
M18	7656	8656
M22	7657	8657

Assorted Box Part No. 7657A

Aluminium Sealing Ring



Thread Size	Part No.	Pkt No.
M10	7630	
M12	7631	
M14	7632	8632
M16	7633	8633
M18	7634	8634
M22	7635	8635
M26	7636	

Assorted Box Part No. 7635A

Bonded Sealing Ring



Thread Size	Part No.	Pkt No.
M10	7664	8664
M12	7665	8665
M14	7666	8666
M16	7667	8667
M18	7668	8668
M22	7669	8669
1/4"	Z7663	
3/8"	Z7664	
1/2"	Z7665	
3/4"	Z7666	

Assorted Box Part No. 7669A

Components

Tube Supports



Tube OD	Tube ID	Part No	Pkt No
6mm	4mm	5151	3151
8mm	6mm	5152	3152
9mm	6mm	5152	3152
10mm	7mm	5153	3153
10mm	7.5mm	5160	3160
10mm	8mm	5154	3154
12mm	8mm	5154	3154
12mm	9mm	5155	3155
13mm	9mm	5155	3155
14mm	10mm	5156	3156
15mm	11mm	5157	3157
15mm	12mm	5158	3158
16mm	12mm	5158	3158
18mm	14mm	5159	3159

Tube supports must always be used with nylon tubing 6mm OD and over

Assorted Box Part No. 3100

For a breakdown of all assorted boxes see section 11

Cutting Ring



Tube OD	Part No	Pkt No
4mm	7584	
6mm	7690	8690
8mm	7691	8691
10mm	7692	8692
12mm	7693	8693
15mm	7694	8694
16mm	7695	8695
18mm	7696	8696

Assorted Box Part No. 7639

For a breakdown of all assorted boxes see section 11

This configuration of fitting assembly is normally used on metal tubing for hydraulic purposes.

When used with nylon tubing it can be replaced with fittings that have an integral cone face.

Fibre Seal



Size ID X OD	Part No	Pkt No
12 x 19	7659	8659
14 x 18	7660	

Cone Ring



Tube OD	Part No
15mm	7708
16mm	7709

Long Tube Nut



Tube OD	Part No
15mm	7688G
13mm (Hose ID)	7687G

Adaptors

Female Steel Adaptors



Female Thread	Female Thread	Part No	Pkt No
M12 x 1.5	M12 X 1.5	7587	
M16 x 1.5	M12 x 1.5	7701G	
M16 x 1.5	M16 x 1.5	7610G	8610
M18 x 1.5	M22 x 1.5	7591	
M22 x 1.5	3/8 BSP	7703	
M22 x 1.5	1/2 BSP	7608	8608
M22 x 1.5	M16 x 1.5	7702	
M22 x 1.5	M22 x 1.5	7609G	8609
M14 x 1.5	M14 x 1.5	7586	

Male Steel Adaptors



Thread A	Thread B	Part No	C/W T&O	Pkt No
M12 x 1.5	M12 x 1.5	7860G	7860T	
M12 x 1.5	M14 x 1.5	7861G	7861T	
M12 x 1.5	M16 x 1.5	7862G	7862T	MAB095
M12 x 1.5	M18 x 1.5	7863G		
M12 x 1.5	M22 x 1.5	7864G		MAB097
M14 x 1.5	M14 x 1.5	7865G		
M14 x 1.5	M16 x 1.5	7866G	7866T	
M16 x 1.5	M14 x 1.5	7866D		
M14 x 1.5	M22 x 1.5	7867G		MAB100
M16 x 1.5	M10 x 1		7986T	
M16 x 1.5	M16 x 1.5	7868G	7868T	MAB101
M16 x 1.5	M18 x 1.5		7951T	
M16 x 1.5	M26 x 1.5	7627	7627T	
1/4 BSPP	M16 x 1.5	7987G	7987T	
M18 x 1.5	M18 x 1.5	7870G		MAB103
M18 x 1.5	M22 x 1.5		7871T	MAB104
M22 x 1.5	M16 x 1.5	7869G	7869T	MAB102
M22 x 1.5	M22 x 1.5	7872G	7872T	MAB105
M22 x 1.5	M26 x 1.5	7873G	7873T	
1/8 NPT	M12 x 1.5	7874G		
1/4 NPT	M12 x 1.5	7875G		
1/4 NPT	M14 x 1.5	7876G		
1/4 NPT	M16 x 1.5	7877G	7877T	MAB109
3/8 NPT	M16 x 1.5	7878G		MAB110
3/8 BSPP	M18 x 1.5	7989G		
1/2 NPT	M22 x 1.5	7879G	7879T	MAB111

Malleable Iron Reducing Bush



Female Thread	Male Thread	Part No	Pkt No
1/8 BSP	1/4 BSP	0314	MAL001
1/4 BSP	3/8 BSP	0346	MAL002
1/4 BSP	1/2 BSP	0347	MAL003
1/4 BSP	3/4 BSP	0349	
3/8 BSP	1/2 BSP	0367	MAL004
3/8 BSP	3/4 BSP	0369	
1/2 BSP	3/4 BSP	0379	MAL006
1/2 BSP	1 BSP	0380	

Male Brass Adaptor



Thread A	Thread B	Part No
M10 x 1	M10 x 1	4635

Adaptors

Male to Female Steel Adaptors



Male Thread	Female Thread	Part No	C/W T&O	Pkt No
1/4 BSP	M12 x 1.5	7596		
1/4 BSP	M16 x 1.5	7611		8611
1/4 BSP	M22 x 1.5	7612		8612
1/4 BSP	3/8 BSP	7599		8599
3/8 BSP	M16 x 1.5	7615		8615
3/8 BSP	M22 x 1.5	7619		8619
1/2 BSP	M16 x 1.5	7607		8607
1/2 BSP	M18 x 1.5	7598		8598
1/2 BSP	M22 x 1.5	7613		8613
M12 x 1.5	1/4 BSP	7588		
M12 x 1.5	M16 x 1.5	7594	7594T	8594
M12 x 1.5	M22 x 1.5	7704		
M14 x 1.5	M16 x 1.5	7595	7595T	
M14 x 1.5	M22 x 1.5	7705G	7705T	
M16 x 1.5	1/4 BSP	7606	7606T	8606
M16 x 1.5	1/4 NPT	7606NPT		
M16 x 1.5	3/8 BSP	7616	7616T	8616
M16 x 1.5	3/8 NPT	7616NPT		
M16 x 1.5	1/2 BSP	7618	7618T	8618
M16 x 1.5	M16 x 1.5	7600		8600
M16 x 1.5	M22 x 1.5	7617	7617T	8617
M22 x 1.5	1/2 BSP	7614	7614T	8614

Brass Reducing Bush



Female Thread	Male Thread	Part No	Pkt No
1/8 BSP	1/4 BSP	6214	4214
1/4 BSP	3/8 BSP	6246	4246
1/4 BSP	1/2 BSP	6247	4247
3/8 BSP	1/2 BSP	6267	4267
1/2 BSP	3/4 BSP	6279	4279

Brass Threaded Adaptors c/w Integral O Ring



Male Thread	Female Thread	Part No	Pkt No
M16 x 1.5	M12 x 1.5	4604	RA604
M22 x 1.5	M16 x 1.5	4606	RA606
M16 x 1.5	1/8 NPTF	4607	
M16 x 1.5	1/4 NPTF	4608	RA608
M16 x 1.5	3/8 NPTF	4609	
1/4 NPT	M12 x 1.5	4610	RA610
1/4 NPT	M16 x 1.5	4611	RA611
3/8 NPT	M16 x 1.5	4612	

Male to Female Steel Adaptors

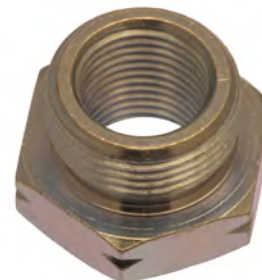

Male Thread	Female Thread	Part No	C/W T&O	Pkt No
M16 x 1.5	M10 x 1	7700	7700T	
M22 x 1.5	1/8 BSP	7601		8601
M22 x 1.5	1/4 BSP	7602	7602T	8602
M22 x 1.5	3/8 BSP	7603	7603T	8603
M22 x 1.5	M16 x 1.5	7604	7604T	8604
M22 x 1.5	M12 x 1.5	7605	7605T	8605
M26 x 1.5	M22 x 1.5	7585	7585T	

Assorted Boxes



Assorted Boxes
 Male to Female Adaptors
 Metric / Imperial
 Part No. 7589
 Female to Male Adaptors
 Metric / Imperial
 Part No. 7590
 Maxi-stor Box Part No. MSK760

For a breakdown of all assorted boxes see section 11

Port Extensions & ISO Cylinders

These port extensions are designed to allow the nylon brake pipe to be indirectly connected to the spring brake / brake chamber. On many of the 'newer' SAF axle applications there is a suspension cross brace that will not allow direct access to the brake chamber ports. Using the WIRA extensions, allows the brake chamber ports to be extended past the cross member.

Aluminium Port Adaptor with Unequal Legs



Port Size	Thread Size	Part No.
M16	M16	7578

Aluminium Port Adaptor with Equal Legs



Port Size	Thread Size	Part No.
M16	M16	7579

Aluminium Port Adaptor with Offset Legs



Port Size	Thread Size	Part No.
M16	M16	7576

length 148mm (both legs)
For Knorr-Bremse brake chamber BS7309

Hose Tails

Threaded Tee Hose Tail



Hose ID	Thread	Part No	C/W T&O
13mm	M22 x 1.5	7828G	7828T

Spigot Adaptor



Hose ID	Thread	Part No
10mm	M22 x 1.5	7990G

Hose Tails

Fixed Hose Tail



Hose ID	Thread Size	Part No	C/W T&O	Pkt No
11mm	M16 x 1.5	7772G	7772T	
11mm	M22 x 1.5	7773	7773T	
13mm	1/4 NPT	7931		
13mm	M16 x 1.5	7774	7774T	MAB114
13mm	M22 x 1.5	7775G	7775T	MAB115
3/8	M16 x 1.5	7894	7894T	MAB116
3/8	1/4 NPT	1710		

Stem Hose Tail



Hose ID	Tube OD	Part No
3/8	10mm	7943G
13mm	10mm	7882G
13mm	12mm	7859G
13mm	15mm	7952G

Swivel Hose Tail



Hose ID	Thread Size	Tube OD	Part No	Pkt No
3/8	M16 x 1.5	10mm	7858G	
11mm	M16 x 1.5	10mm	7857G	
13mm	M16 x 1.5	10mm	7770G	MAB119
13mm	M18 x 1.5	12mm	7771G	

Flat Ended Hose Tail



Hose ID	Part No
13mm	7779G

Use with Hose Nut 7687G

Swivel Hose Tail



Hose ID	Thread	Part No	C/W T&O	Pkt No
3/8	1/4 NPT	1709		HT024
3/8	M16 x 1.5	7926	7926T	HT026
13mm	M16 x 1.5	7895	7895T	HT028
13mm	M22 x 1.5	7898		

Stem Reducer



Stem OD	Tube OD	Part No
8mm	6mm	7911G
10mm	6mm	7912G
10mm	8mm	7913G
12mm	6mm	7914G
12mm	8mm	7915G
12mm	10mm	7916G

WIRA Fittings

Straight Stud



Tube OD	Thread	Part No	C/W T&O	Pkt No
6mm	M10 x 1	7732G		MAB032
6mm	M12 x 1.5	7711G	7711T	MAB033
6mm	M16 x 1.5	7707G	7707T	
8mm	1/4 NPT	7944G		
8mm	M10 x 1	7729G	7729T	MAB034
8mm	M12 x 1.5	7713G	7713T	MAB035
8mm	M14 x 1.5	7714G	7714T	MAB036
8mm	M16 x 1.5	7715G	7715T	MAB037
8mm	M22 x 1.5	7716G	7716T	MAB038
10mm	1/4 NPT	7677G		MAB044
10mm	3/8 NPT	7670G		
10mm	M10 x 1	7712G	7712T	MAB045
10mm	M12 x 1.5	7717G	7717T	MAB046
10mm	M14 x 1.5	7718G	7718T	MAB047
10mm	M16 x 1.5	7719G	7719T	MAB048
10mm	M22 x 1.5	7720G	7720T	MAB049
12mm	1/4 NPT	7678G		MAB055
12mm	3/8 NPT	7679G		
12mm	M12 x 1.5	7721G		MAB056
12mm	M14 x 1.5	7886G		MAB057
12mm	M16 x 1.5	7722G	7722T	MAB058
12mm	M18 x 1.5	7706G		
12mm	M22 x 1.5	7723G	7723T	MAB059
15mm	M16 x 1.5	7726G	7726T	
15mm	M22 x 1.5	7727G	7727T	MAB070
16mm	M22 x 1.5	7731G	7731T	MAB071
18mm	M22 x 1.5	7728G	7728T	MAB072
22mm	M22 x 1.5	7760VT		

Straight Connector



Tube OD	Part No	Pkt No
6mm	7733G	MAB001
8mm	7734G	MAB002
10mm	7735G	MAB004
12mm	7736G	MAB006
15mm	7737G	MAB009
16mm	7738G	MAB010
18mm	7739G	MAB011

Unequal Straight Connector



Tube	Tube	Part No
22mm	18mm	7730G

Straight Stem Stud



Thread	Stem OD	Part No
M12 x 1.5	8mm	7923G
1/4 NPT	10mm	7949G
M22 x 1.5	12mm	7921G
M22 x 1.5	15mm	7922G

Straight Bulkhead Adaptor



Thread A	Thread B	Part No	C/W T&O	Pkt No
M16 x 1.5	M16 x 1.5	7896G	7896T	
M16 x 1.5	M22 x 1.5	7928G	7928T	
M22 x 1.5	M12 x 1.5	7961	7961T	
M22 x 1.5	M14 x 1.5	7740G	7740T	
M22 x 1.5	M16 x 1.5	7741G	7741T	
M22 x 1.5	M22 x 1.5	7742G	7742T	MAB078
1/2 BSP	M22 x 1.5	7755G		MAB082
M22 x 1.5	M18 x 1.5	7760G		

Bulkhead Connector



Short Thread	Long Thread	Part No
M22 x 1.5	M22 x 1.5	8742B

Straight Bulkhead Connector



Tube OD	Part No
6mm	7748G
8mm	7749G
10mm	7750G
12mm	7751G
15mm	7752G
16mm	7753G
18mm	7754G

Straight Bulkhead Stud



Tube OD	Thread	Part No	C/W T&O	Pkt No
8mm	M16 x 1.5		7978T	
8mm	M22 x 1.5	7756G	7756T	MAB084
10mm	M16 x 1.5	7743G	7743T	MAB085
10mm	M22 x 1.5	7744G	7744T	MAB086
12mm	M22 x 1.5	7745G	7745T	MAB087
15mm	M22 x 1.5	7746G	7746T	

Straight Female Stud



Tube OD	Thread	Part No
6mm	M22 x 1.5	7757G
8mm	M22 x 1.5	7759G
10mm	M22 x 1.5	7761G
12mm	M22 x 1.5	7763G
15mm	M22 x 1.5	7765G

Maxi-stor Assorted Box



Wira compression range
Part No. MSK770

For a breakdown of all assorted boxes see section 11

WIRA Fittings

Elbow Stud



Tube OD	Thread	Part No	C/W T&O	Pkt No
8mm	M12 x 1.5	7780G	7780T	MAB123
8mm	M14 x 1.5	7940G		
8mm	M16 x 1.5	7899G		MAB124
8mm	M22 x 1.5	7798G		
10mm	1/4 NPT	7807G		MAB126
10mm	3/8 NPT	7855G		
10mm	M12 x 1.5	7781G	7781T	MAB127
10mm	M14 x 1.5	7782G	7782T	MAB128
10mm	M16 x 1.5	7783G	7783T	MAB129
10mm	M22 x 1.5	7784G	7784T	MAB130
12mm	3/8 NPT	7795G		
12mm	M16 x 1.5	7789G	7789T	MAB131
12mm	M18 x 1.5	7942G		
12mm	M22 x 1.5	7785G	7785T	MAB132
15mm	M22 x 1.5	7786G	7786T	MAB133
16mm	M22 x 1.5	7788G	7788T	
18mm	M22 x 1.5	7787G	7787T	

Elbow Bulkhead Connector



Tube OD	Part No
6mm	7790G
8mm	7791G
10mm	7792G
12mm	7793G
15mm	7794G

Elbow Connector



Tube OD	Part No	Pkt No
6mm	7800G	MAB013
8mm	7801G	MAB014
10mm	7802G	MAB016
12mm	7803G	MAB018
15mm	7804G	
16mm	7805G	
18mm	7806G	MAB021

Stem Elbow Adaptor



Stem OD	Tube OD	Part No	Pkt No
6mm	6mm	7917G	
8mm	8mm	7883G	MAB135
10mm	10mm	7799G	MAB136
12mm	12mm	7893G	MAB137
15mm	15mm	7900G	

Male - Male Elbow Adaptor



Thread A	Thread B	Part No	C/W T&O
M22 x 1.5	M22 x 1.5	7850G	7850T
M16 x 1.5	M22 x 1.5		7997T

WIRA Fittings

45 Degree Elbow



Thread	Tube OD	Part No	C/W T&O
M16 x 1.5	12mm	7979G	7979T

45 Degree Elbow



Thread	Tube OD	Part No
M16 x 1.5	10mm	7980T
M16 x 1.5	12mm	7981T

45 Degree Stem Elbow



Thread Female	Thread Male	Part No
M16 x 1.5	M16 x 1.5	7982G
M18 x 1.5	M18 x 1.5	7983G

Male - Female Elbow 90 Degree



Thread A	Thread B	Part	C/W T&O	Pkt No
M16 x 1.5	M16 x 1.5	7808G	7808T	MAB144
M22 x 1.5	M22 x 1.5	7809G	7809T	MAB145

Hose Tail Tee



Hose ID	Thread	Part No	C/W T&O
13mm	M22 x 1.5	7828G	7828T

Branch Stem Tee



Tube OD	Stem OD	Thread Size	Part No	Pkt No
6mm	6mm	M12 x 1.5	7909G	
8mm	8mm	M14 x 1.5	7891G	MAB151
10mm	10mm	M16 x 1.5	7853G	MAB152
12mm	12mm	M18 x 1.5	7885G	

Tee Connector



Tube OD	Part No	Pkt No
6mm	7810G	MAB022
8mm	7811G	MAB023
10mm	7812G	MAB025
12mm	7813G	MAB026
15mm	7814G	
16mm	7815G	
18mm	7816G	

WIRA Fittings

Reducing Tee Connector



Tube OD.A	Tube OD.B	Tube OD.C	Part No
12mm	10mm	12mm	7903G
12mm	8mm	12mm	7904G

Side Stud Tee



Thread	Tube OD	Part No	C/W T&O
M12 x 1.5	8mm	7934G	
M12 x 1.5	10mm		7953T
M16 x 1.5	10mm	7929G	7929T
M16 x 1.5	12mm		7960T
M22 x 1.5	10mm	7933G	

Side Stem Tee



Stem OD	Tube OD	Part No	Pkt No
6mm	6mm	7907G	
8mm	8mm	7890G	MAB147
10mm	10mm	7854G	MAB148
12mm	8mm	7941G	
12mm	12mm	7884G	MAB149

Branch Stud Tee



Tube OD	Tube OD	Thread	Part No	C/W T&O
8mm	8mm	M12 x 1.5	7848G	
10mm	10mm	M12 x 1.5	7829G	7829T
10mm	10mm	M16 x 1.5	7881G	7881T
10mm	10mm	M22 x 1.5	7817G	
12mm	12mm	M16 x 1.5	7947G	
12mm	12mm	M22 x 1.5	7818G	
15mm	15mm	M22 x 1.5	7819G	

Female Tee



Thread Size	Part No	Pkt No
M16 x 1.5	7889G	MAB156

Stud Cross



Tube OD	Thread	Part No
10mm	M22 x 1.5	7977T

Tee Bulkhead Connector



Tube OD	Part No
10mm	7822G

Male Tee Adaptor



Thread	Part No	C/W T&O
M22 x 1.5	7887G	7887T

Elbow Stud Hose Tail



Thread	Tube ID	Part No
M16 x 1.5	13mm	7897G

Tee Bulkhead Connector



Thread	Part No
M22 x 1.5	7849G

Test Points

Female Test Point



Thread	Part No	Pkt No
M12 x 1.5	7830	
M14 x 1.5	7962	
M16 x 1.5	7831	MAB173
M18 x 1.5	7963	
M22 x 1.5	7832	

Male Test Point



Thread	Part No	C/W T&O	Pkt No
1/4 NPT	7833		MAB157
M12 x 1.5	7834	7834T	MAB158
M14 x 1.5		7974T	
M16 x 1.5		7835T	MAB159
M22 x 1.5		7836T	MAB160

Test point Adaptor



Thread	Hose ID	Part No	Pkt No
M16 x 1.5	3/16	8000	MAB170
M16 x 1.5	1/4	8000.4	MAB172
M16 x 1.5	3/8	8000.6	MAB171

Side Stud Tee Test Point



Tube OD	Thread	Part No	C/W T&O	Pkt No
10mm	M12 x 1.5	7847G		
10mm	M16 x 1.5	7843G	7843T	MAB164
10mm	M22 x 1.5	7842G		MAB165
12mm	M16 x 1.5	7948G	7948T	
13mm Hose	M16 x 1.5	7918G	7918T	

Tee Test Point



Tube OD	Part No
10mm	7838G
12mm	7839G

The New C Coupling Standard BS AU138b - 2000 supersedes BS AU138a - 1980

and is designed to

- 1 Eliminate the problems of mismatched components with a one piece construction that cannot be dismantled
- 2 Improve airflow with an increased Valve Lift
- 3 Improve life span with increased Surface Protection
- 4 Colour Coded for safety
- 5 Metric threads to avoid sealing problems of taper threads

Tractor Emergency Line Coupling



Thread	Part No.
M16 x 1.5	0161R
M22 x 1.5	0156R

Trailer Service Line Coupling



Thread	Part No.
M22 x 1.5	0152R

Trailer Emergency Line Coupling



Thread	Part No.
M22 x 1.5	0151R

Tractor Service Line Coupling



Thread	Part No.
M16 x 1.5	0160R
M22 x 1.5	0155R

Trailer Service Line Coupling



Thread	Part No.
M16 x 1.5	0172B
M22 x 1.5	0152B

Trailer Emergency Line Coupling



Thread	Part No.
M16 x 1.5	0171B



Coupling Grips

Colour	Part No.
Red & Yellow (Pair)	0166

C Coupling handles are colour coded, made of rubber and provide additional grip when fitting mating coupling. Illustration shows coupling with handle on.

Couplings

Emergency Line

Self Sealing Valve



Thread	Part No.
1/2 BSP	0106
M22 x 1.5	0106M

Female C Coupling



Thread	Part No.
1/2 BSP	0102
M22 x 1.5	0102M

Male C Coupling



Thread	Part No.
1/2 BSP	0101
M22 x 1.5	0101M

Auxiliary Line

Self Sealing Valve



Thread	Part No.
1/2 BSP	0106
M22 x 1.5	0106M

Female CA Coupling



Thread	Part No.
1/2 BSP	0104
M22 x 1.5	0104M

Male CA Coupling



Thread	Part No.
1/2 BSP	0103
M22 x 1.5	0103M

Service Line

Self Sealing Valve



Thread	Part No.
1/2 BSP	0105
M22 x 1.5	0105M

Male C Coupling



Thread	Part No.
1/2 BSP	0101
M22 x 1.5	0101M

Female C Coupling



Thread	Part No.
1/2 BSP	0102
M22 x 1.5	0102M

Valve Lifter



Thread	Part No.
1/2 BSP	0107
M22 x 1.5	0107M

Description	Thread	Part No.
Female C Coupling with Valve Lifter	1/2 BSP	0110
Female C Coupling with Valve Lifter	M22 x 1.5	0110M



Coupling Cover

Description	Suits	Part No
Red	0151R	0157
Yellow	0152R	0158
Cable	0157 & 0158	0159

Dummy Couplings

Dummy Coupling Female



Part No.

0118

Dummy Coupling Male



Description

Part No

Without Chain

0117

With Chain

0117C

Dummy Coupling With Bolt



Part No.

0117WB

These couplings are made to a similar pattern to the standard BS AU138a/b couplings and are designed to provide secure parking locations for the tractor couplings. To ensure the air coils remain undamaged while parked, the overall length of the dummy couplings has been kept to a minimum. The couplings incorporate the same locking mechanism as the standard couplings and are plated to the same specifications.

Coupling Tester



The coupling tester is used to verify correct manufacturing and fitting of the female service line coupling ensuring the correct amount of valve lift.

Description

Part No

Coupling Tester

0115

Angled Bulkhead Fitting



This fitting allows the coupling to be angled for convenience.

M Thread

F Thread

Part No.

M22 x 1.5

M16 x 1.5

0120

Trailer C Locks



Description

Part No

Standard lock

0119R

Standard lock with same key

0119RS

VOR lock

0119VOR

VOR lock with same key

0119VORS

Spare Key

0119SK

The trailer C-lock has been designed to be compact (length when unlocked - 98mm, locked length - 110mm, dia - 38mm), rugged and simple to operate. When locked onto the trailer male c-coupling it prevents coupling up to, or removal of, the male coupling. To fit the coupling, simply remove the key and push the lock onto the male, sliding the outer sleeve forward until it clicks. To remove the lock, insert the key and turn. Many key combinations available.

Palm Couplings

Self Sealing Palm Couplings



Thread	Colour	Part No
M16 x 1.5	Yellow	0126
M16 x 1.5	Red	0127

Operating Palm Couplings



Thread	Colour	Part No
M22 x 1.5	Yellow	0128
M22 x 1.5	Red	0129
1/2 BSP	Yellow	0130
1/2 BSP	Red	0131

Replacement Rubber Part No. 0123

Universal Palm Couplings



Replacement Rubber
Part No. 0123

Thread	Part No
1/2 BSP	0121
M22 x 1.5	0122

In-line Filter



Thread	Part No
M22 x 1.5	0125

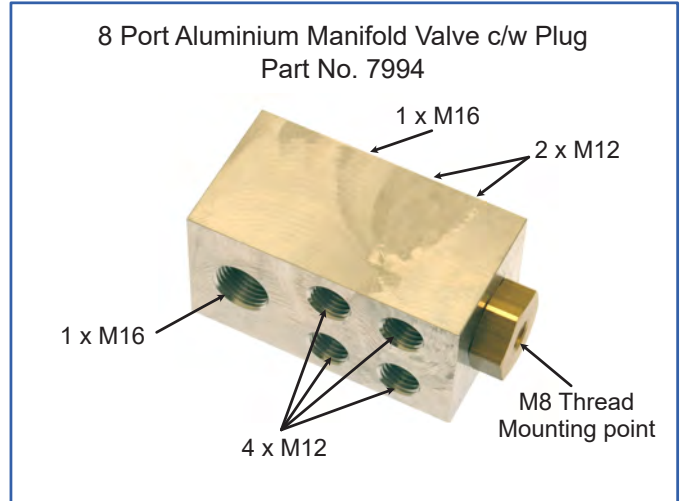
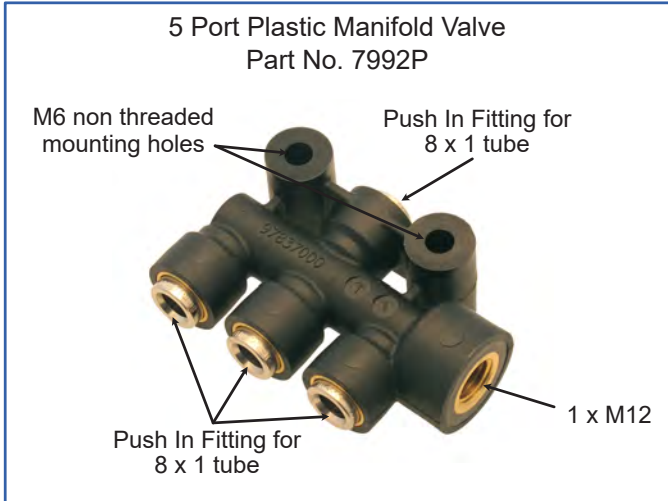

Page 3.2 - 3.3

Push In - Metric

This range of nickel plated brass push in fittings provides a secure joint without the use of any tools, making them quick and easy to fit. They can be used on nylon, plastic, calibrated copper or Bundy Tubes to carry air, water, and other fluids in industrial applications.

Page 3.4

Push In - Imperial

This range of nickel plated brass push in fittings provides a secure joint without the use of any tools, making them quick and easy to fit. They can be used on nylon, plastic, calibrated copper or Bundy Tubes to carry air, water, and other fluids in industrial applications.

Page 3.5 - 3.8

Plastic Push In Metric

This range of plastic push-in fittings provide a secure joint without the use of any tools making them quick and easy to fit. They can be used on nylon, plastic, calibrated copper or Bundy Tubes to carry air, water and many other liquids, except acids but not suitable for fuel.

Page 3.9 - 3.10

Plastic Push In Imperial

This range of plastic push-in fittings provide a secure joint without the use of any tools making them quick and easy to fit. They can be used on nylon, plastic, calibrated copper or Bundy Tubes to carry air, water and many other liquids, except acids but not suitable for fuel.

Page 3.11 - 3.14

QR Air Line Couplings

Tube Gear as an Extensive range of Quick Release Airline Couplings with a wide range of Working pressures and flow rates

Page 3.15

Blow Guns

This range of low noise safety blowguns meet the OSHA standard; models featuring automatic pressure reduction and air curtains, this range of ergonomically designed air blowguns and air powered vacuum cleaners are ideal for the workshop.

Page 3.15

Tyre Inflation Products

Our range of tyre inflation products are designed and manufactured using the highest quality materials, clear and easy to read to ensure accuracy in the garage, workshop and service bays

METRIC PUSH IN FITTINGS

This range of nickel plated brass push in fittings provides a secure joint without the use of any tools, making them quick and easy to fit. They can be used on nylon, plastic, calibrated copper or Bundy Tubes to carry air, water, and other fluids in industrial applications. Maximum working pressure 18 bar. Temperature range -30°C to + 80°C.

Straight Connector



Tube OD	Part No	Pkt No
4mm	2801	PIF300
5mm	2802	PIF301
6mm	2803	PIF803
8mm	2804	PIF804
10mm	2805	PIF805
12mm	2806	PIF806
14mm	2807	

Equal Tee Connector



Tube OD	Part No	Pkt No
4mm	2810	PIF315
5mm	2811	
6mm	2812	
8mm	2813	PIF813
10mm	2814	PIF814

Straight Stud Connector



Tube OD	Thread BSP	Part No	Part No
4mm	1/8	2830	PIF557
4mm	1/4	2831	
5mm	1/8	2832	
5mm	1/4	2833	
6mm	1/8	2834	PIF834
6mm	1/4	2835	PIF835
8mm	1/8	2836	PIF836
8mm	1/4	2837	PIF837
8mm	3/8	2838	
8mm	1/2	2839	
10mm	1/8	2840	PIF840
10mm	1/4	2841	PIF841
10mm	3/8	2842	
10mm	1/2	2843	
12mm	1/4	2844	

Swivel Branch Tee



Tube OD	Thread BSP	Part No
4mm	1/8	2885
5mm	1/8	2887
6mm	1/8	2889
6mm	1/4	2890
8mm	1/8	2891
8mm	1/4	2892
10mm	1/4	2894

Swivel Stud Elbow



Tube OD	Thread BSP	Part No	Part No
4mm	1/8	2849	PIF584
4mm	1/4	2850	PIF588
5mm	1/8	2851	PIF585
5mm	1/4	2852	PIF852
6mm	1/8	2853	PIF853
6mm	1/4	2854	PIF854
6mm	3/8	2855	PIF855
8mm	1/8	2856	PIF856
8mm	1/4	2857	PIF857
8mm	3/8	2858	PIF858
8mm	1/2	2859	
10mm	1/8	2860	PIF860
10mm	1/4	2861	PIF861
10mm	3/8	2862	
10mm	1/2	2863	

Elbow Connector



Tube OD	Part No	Pkt No
4mm	2820	PIF331
5mm	2821	
6mm	2822	
8mm	2823	
10mm	2824	

Bulkhead Connector



Tube OD	Thread	Part No
4mm	M10 x 1	2825
6mm	M14 x 1	2827
8mm	M16 x 1	2828
10mm	M20 x 1	2829

Swivel Side Stud Tee



Tube OD	Thread BSP	Part No
6mm	1/8 BSP	2873
6mm	1/4 BSP	2874
8mm	1/8 BSP	2875

Stem Reducer



Tube OD	Stem OD	Part No
4mm	6mm	2990
4mm	8mm	2991
4mm	10mm	2992
6mm	8mm	2993
6mm	10mm	2994
8mm	10mm	2995
8mm	12mm	2996
10mm	12mm	2997

Stud Elbow



Tube OD	Thread BSP	Part No
8mm	1/2 BSP	6803

Straight Stud



Tube OD	Thread BSP	Part No	Pkt No
5/32	1/8 BSP	2931	
3/16	1/8 BSP	2932	
3/16	1/4 BSP	2935	PIF504
1/4	1/8 BSP	2933	
1/4	1/4 BSP	2936	
5/16	1/8 BSP	2934	
5/16	1/4 BSP	2937	
3/8	1/4 BSP	2938	

Swivel Stud Elbow



Tube OD	Thread	Part No	Pkt No
5/32	1/8 BSP	2950	
5/16	1/8 BSP	2953	
5/16	1/4 BSP	2956	
1/4	1/8 BSP	2952	
1/4	1/4 BSP	2955	
3/16	1/8 NPT	2951NPT	
3/16	1/8 BSP	2951	PIF519
3/16	1/4 NPT	2954NPT	
3/16	1/4 BSP	2954	
3/8	1/4 BSP	2957	
3/8	3/8 BSP	2958	
3/8	1/2 BSP	2960	

Straight Connector



Tube OD	Part No
5/32	2901
3/16	2902
1/4	2903
5/16	2904
3/8	2905
1/2	2906

Elbow Connector



Tube OD	Part No
5/32	2921

Swivel Branch Stud Tee



Tube OD	Thread BSP	Part No
3/8	3/8	2988

Equal Tee Connector



Tube OD	Part No
3/16	2912
1/4	2913

This range of plastic push-in fittings provide a secure joint without the use of any tools making them quick and easy to fit. They can be used on nylon, plastic, calibrated copper or Bundy Tubes to carry air, water and many other liquids, except acids **but not suitable for fuel**. We recommend the use of tube supports with nylon or plastic tubing.

We do not advise the use of plastic push-in fittings on vehicle brake lines.

Maximum working pressure 10 bar. Minimum burst pressure 25 bar. Temp: 0 to +60°C.

Equal Tee Connector



Tube OD	Part No	Pkt No
4mm	4451	PIF021
5mm	4452	PIF022
6mm	4453	PIF023
8mm	4454	PIF024
10mm	4455	PIF026
12mm	4456	PIF028
16mm	4458	

Assorted Box Part No. Z4450

Straight Connector



Tube OD	Part No	Pkt No
4mm	4410	PIF001
5mm	4411	PIF002
6mm	4412	PIF003
8mm	4413	PIF004
10mm	4415	PIF006
12mm	4416	PIF008
16mm	4419	

Assorted Box Part No. 2420
For a breakdown of all assorted boxes see section 11

Swivel Elbow



Tube OD	Thread BSPT	Part No	Pkt No
4mm	1/8 BSPT	4461	PIF186
6mm	1/8 BSPT	4462	
6mm	1/4 BSPT	4463	
8mm	1/8 BSPT	4469	
8mm	1/4 BSPT	4470	PIF194
10mm	1/4 BSPT	4464	
10mm	3/8 BSPT	4465	
12mm	3/8 BSPT	4467	
10mm	1/2 BSPT	4466	
12mm	1/2 BSPT	4468	

Elbow Connector



Tube OD	Part No	Pkt No
4mm	4471	PIF011
6mm	4473	PIF013
8mm	4474	PIF014
10mm	4475	PIF016
12mm	4476	PIF018
16mm	4478	

Assorted Box Part No. Z4470

Y Connector



Tube OD	Part No	Pkt No
6mm	4481	PIF197
8mm	4482	PIF198
10mm	2819	PIF199

Straight Stud



Tube OD	Thread	Part No
8mm	1/4 BSPP	4459

Straight Stud



Tube OD	Thread BSPT	Part No	Pkt No
4mm	1/8 BSPT	4441	PIF031
6mm	1/8 BSPT	4442	
8mm	1/8 BSPT	4449	
6mm	1/4 BSPT	4443	PIF033
8mm	1/4 BSPT	4450	PIF034
10mm	1/4 BSPT	4444	PIF036
10mm	3/8 BSPT	4445	
12mm	3/8 BSPT	4447	
10mm	1/2 BSPT	4446	
12mm	1/2 BSPT	4448	

Assorted Boxes

Metric push in Part No. MSK240
Plastic push in straights & elbows
Part No. 2430

For a breakdown of all assorted boxes see section 11

This range of plastic push-in fittings provide a secure joint without the use of any tools making them quick and easy to fit. They can be used on nylon, plastic, calibrated copper or Bundy Tubes to carry air, water and many other liquids, except acids **but not suitable for fuel**. We recommend the use of tube supports with nylon or plastic tubing.

We do not advise the use of plastic push-in fittings on vehicle brake lines.

Maximum working pressure 10 bar. Minimum burst pressure 25 bar. Temp: -20 to +70°C.

Straight Connector



Tube OD	Part No	Pkt No
4mm	2411	
5mm	2412	
6mm	2413	
8mm	2414	
10mm	2415	
12mm	2416	
15mm	2417	PIF010
18mm	2418	
22mm	2419	
28mm	2410	

Equal Tee Connector



Tube OD	Part No	Pkt No
4mm	2451	
5mm	2452	
6mm	2453	
8mm	2454	
10mm	2455	
12mm	2456	
15mm	2457	PIF030
18mm	2458	
22mm	2459	
28mm	2460	

Elbow Connector



Tube OD	Part No	Pkt No
5mm	2472	PIF012
6mm	2473	
8mm	2474	
10mm	2475	
12mm	2476	
15mm	2477	PIF020
18mm	2478	
22mm	2479	
28mm	2480	

Straight Stud



Tube OD	Thread	Part No
4mm	1/8 BSPT	2601
6mm	1/4 BSPT	2606
8mm	1/4 BSPT	2608
10mm	1/4 BSPT	2610
10mm	3/8 BSPT	2611
12mm	3/8 BSPT	2612

Stem Elbow



Tube OD	Part No
4mm	2541
6mm	2543
8mm	2544
10mm	2545
12mm	2546

Stem Stud



Tube OD	Thread	Part No
5mm	1/8 BSPT	2523
6mm	1/4 BSPT	2526
8mm	1/4 BSPT	2528
10mm	1/4 BSPT	2530

Reduce Tee Connector



Tube A OD	Tube B OD	Tube C OD	Part No.
22mm	22mm	15mm	2448

Bulkhead Connector



Tube OD	Part No
6mm	2713
8mm	2714
10mm	2715

End Stop



Tube OD	Part No
10mm	2792
12mm	2793

Stem Reducer



Tube OD	Stem	Part No	Pkt No
4mm	6mm	2492	PIF130
5mm	6mm	2493	
6mm	8mm	2495	PIF132
8mm	10mm	2497	PIF134
8mm	12mm	2498	PIF136
10mm	12mm	2499	PIF138
12mm	15mm	2487	

Plug



Tube OD	Part No	Pkt No
4mm	2731	
6mm	2733	PIF201
8mm	2734	
10mm	2735	PIF203
12mm	2736	PIF204
15mm	2737	

Assorted Box Part No. 2720
For a breakdown of all assorted boxes see section 11

Reducer Straight Connector



Tube OD	Tube OD	Part No	Pkt No
6mm	4mm	2431	PIF148
8mm	6mm	2433	PIF147
10mm	6mm	2434	PIF149
10mm	8mm	2435	PIF150
10mm	12mm	2432	

Assorted Box Part No. Z2430
For a breakdown of all assorted boxes see section 11

Stem Y Connector



Tube OD	Part No
8mm	2808
10mm	2809

Plugs



Tube OD	Colour	Part No
8mm	White	4734
6mm	Acetal	6408
8mm	Acetal	6409
10mm	Acetal	6410

Swivel Elbow



Tube OD	Thread	Part No	Pkt No
4mm	1/8 BSPT	2661	PIF186
5mm	1/8 BSPT	2663	
6mm	1/8 BSPT	2664	
6mm	1/4 BSPT	2666	
8mm	1/8 BSPT	2667	
8mm	1/4 BSPT	2668	
10mm	1/4 BSPT	2670	

Collet Release Tool



Description	Part No
Release Tool	2399

Assorted Box



Description	Part No
Plastic push in reducers	2490

For a breakdown of all assorted boxes see section 11

Elbow Connector



Tube OD	Part No
1/4	4437
3/8	4439
1/2	4440

Straight Connector



Tube OD	Part No	Pkt No
5/32	4421	PIF057
3/16	4422	PIF058
1/4	4423	PIF059
5/16	4424	
3/8	4425	PIF061
1/2	4426	PIF062

Assorted Box Part No. 2400
For a breakdown of all assorted boxes see section 11

Equal Tee Connector



Tube OD	Part No	Pkt No
5/32	4428	
3/16	4429	
1/4	4430	PIF073
3/8	4432	PIF075
1/2	4433	PIF076

Main Ring Air Fittings

Brass Straight Stud



Tube OD	Thread BSPT	Part No
22mm	3/4	2594

Brass Wingback Elbow



Tube OD	Thread BSPP	Part No
22mm	3/4	2597

Brass Stem Stud



Tube OD	Thread BSPT	Part No
15mm	1/2	2436

Tube Gear Blister Packs

Most parts can be ordered in packets that are designed for use with wall mounted display stands, this makes selling and reordering easier with each packet part numbered



This range of plastic push-in fittings provide a secure joint without the use of any tools making them quick and easy to fit. They can be used on nylon, plastic, calibrated copper or Bundy Tubes to carry air, water and many other liquids, except acids **but not suitable for fuel**. We recommend the use of tube supports with nylon or plastic tubing.

We do not advise the use of plastic push-in fittings on vehicle brake lines.

Maximum working pressure 10 bar. Minimum burst pressure 25 bar. Temp: 0 to +60°C.

Swivel Elbow



Tube OD	Thread BSPT	Part No
1/4	1/8	2642

Elbow Connector



Tube OD	Part No
1/2	2466

Plug



Tube OD	Part No
5/16	2724

Straight Connector



Tube OD	Part No
5/32	2401
3/16	2402
1/4	2403
5/16	2404
3/8	2405
1/2	2406

Straight Stud



Tube OD	Thread BSPT	Part No
3/16	1/8 BSPT	2583
1/4	1/8 BSPT	2584
1/4	1/4 BSPT	2585
3/8	3/8 BSPT	2590
1/2	3/8 BSPT	2591

Standard Air Flow Coupling Male



Thread Size	Part No
1/4 BSP	0915
3/8 BSP	0916
1/2 BSP	0917

Standard Air Flow Coupling Female



Thread Size	Part No
1/4 BSP	0918
3/8 BSP	0919
1/2 BSP	0911

Standard Air Flow Coupling Hose Tail



Hose ID	Part No
3/8	0923

35-42 CFM flow rate @ 7Bar single action release for ease in fixed applications

Slimline Vertex Coupling Female



Thread Size	Part No
1/4 BSP	0920
3/8 BSP	0956
1/2 BSP	0957

Slimline Vertex Coupling Male



Thread Size	Part No
1/4 BSP	0921
3/8 BSP	0958
1/2 BSP	0959

Multi-Fit Coupling Male



Thread Size	Part No
3/8 BSP	0951

35-42 CFM flow rate @ 7Bar. Ideal for use with trailing hoses because of its double action release

These couplings are compatible with bayonet forms CEJN 320. RECTUS 25. ARO210. ISO B12. SNAPON

Bayonet To Hose Connector



Hose ID	Part No
1/4	0929
5/16	0930
3/8	0931

Bayonet Fitting Male



Thread Size	Part No
1/4 BSP	0925
3/8 BSP	0926
1/2 BSP	0927

Bayonet Fitting Female



Thread Size	Part No
1/4 BSP	0928
3/8 BSP	0954
1/2 BSP	0955

Quick Release Air Line Couplings

High Flow Couplings Male



Thread Size	Part No
1/4 BSP	0901
3/8 BSP	0902
1/2 BSP	0903

High Flow Couplings Female



Thread Size	Part No
1/4 BSP	0904
3/8 BSP	0905

Bayonet Hose Connector



Hose ID	Part No
3/8	0913
1/2	0914

High Flow Couplings Male



Thread Size	Part No
1/4 BSP	0907
3/8 BSP	0908
1/2 BSP	0909

High Flow Couplings Female



Thread Size	Part No
1/4 BSP	0910

HIGH FLOW COUPLINGS 78CFM flow rate @ 7 bar compatible with CEJN 320.RECTUS 25.

Key Product: Benefits Two stage self-venting release, Creates a safe compressed air environment, Safe and simple to use, Best practice for compressed air users, Enhances workshop safety - prevents hose whip, Patent design, Conforms to ISO 4414:1998 and EN 983:1996

Safe Flow Couplings Male



Thread Size	Part No
3/8 BSP	0961

Safe Flow Couplings Female



Thread Size	Part No
1/4 BSP	0962
3/8 BSP	0963

60 CFM FLOW RATE @ 7BAR

Couplings Male



Thread Size	Part No
1/4 BSP	0980
3/8 BSP	0981
1/2 BSP	0982

Couplings Female



Thread Size	Part No
1/4 BSP	0983
3/8 BSP	0984
1/2 BSP	0985

Male Adaptor



Thread Size	Part No
1/4 BSP	0986
3/8 BSP	0987

Female Adaptor



Thread Size	Part No
1/4 BSP	0988
3/8 BSP	0989

Male Safety Adaptor



Thread Size	Part No
3/8 BSP	0993

Hose Tail



Hose ID	Part No
3/8	0991
1/2	0992

For a full range of Metric & Imperial Air Brake Hose see section 6

Imperial Hose

This braided rubber hose is manufactured to the air brake standard SAE J1402, has a burst pressure of 62 bar and a working pressure of 15.5 bar



Metric Hose

Manufactured to DIN 74310 standard this hose has a burst pressure of 54 bar and working pressure of 18 bar

100 Series Quick Release Air Line Couplings

120 CFM FLOW RATE @ 7BAR

Couplings Male



Thread Size	Part No
3/8 BSP	0932
1/2 BSP	0933

Couplings Female



Thread Size	Part No
3/8 BSP	0934
1/2 BSP	0935

Couplings Male



Thread Size	Part No
3/8 BSP	0936
1/2 BSP	0937

Couplings Female



Thread Size	Part No
3/8 BSP	0938

Hose Coupling Male



Tube ID	Part No
3/8	0939
1/2	0940

Hose Connector



Hose ID	Part No
1/4	HT003
5/16	HT005
3/8	HT007
1/2	HT009

Hose Tail Female



Thread Size	Hose ID	Part No
1/8 BSP	6mm	0943

Y Connector



Thread Size	Part No
1/4 BSP	0922
3/8 BSP	0924

Hose Tail Male



Thread	Hose ID	Part No	Pack No	Thread	Hose ID	Part No	Pack No
1/8 BSP	6mm	0941		1/4 BSP	1/2	0947	HT015
1/8 BSP	10mm	0942		3/8 BSP	1/4	0964	HT016
1/4 BSP	3/16	0890		3/8 BSP	5/16	0965	HT017
1/4 BSP	1/4	0944	HT012	3/8 BSP	3/8	0966	HT018
1/4 NPT	1/4	0891		3/8 BSP	1/2	0967	HT019
1/4 BSP	5/16	0945	HT013	1/2 BSP	3/8	0976	HT020
1/4 BSP	3/8	0946	HT014	1/2 BSP	1/2	0977	HT021

Palm Held Blow Gun



Thread Size	Part No	Nozzle
1/4 BSP	6920	Conical

Economy Blow Gun



Thread Size	Part No	Nozzle
1/4 BSP	6928	Conical

Single Clip On



Hose ID	Part No
1/4	6934

Pistol Grip Blow Gun



Thread	Part No	Nozzle
1/4 BSP	6929	Conical & Safety

Plastic Blow Gun



Thread Size	Part No	Nozzle
1/4 BSP	6926	Safety

Economy Blow Gun



Thread	Part No	Nozzle
1/4 BSP	6922	Conical & Safety

Twin Clip On Inflator (Open Ended)



Thread Size	Part No
1/4 BSP	6932

Air Line Gauge With Twin Clip On Inflator (6ft Hose)



Thread Size	Part No
1/4 BSP	6930

Twin Hold On Inflator (Open Ended)



Thread Size	Part No
1/4 BSP	6931

Page 4.2 - 4.3 Brass Compression Metric

Wide range of Metric Brass Compression Fitting Inc Straights, Tees, Elbows and Studs

Page 4.4 - 4.6 Brass Compression Imperial

Wide range of Imperial Brass Compression Fitting Inc Straights, Tees, Elbows and Studs

Page 4.7 - 4.8 Malleable Iron Fittings

Tube Gear Wide Range of Malleable Iron Fittings

Page 4.8**Thread Seal Tape**

Thread Seal Tape for used to seal tapered threads.

Tube Support



Tube OD	Tube ID	Part No	Pkt No
6mm	4mm	5151	3151
8mm	6mm	5152	3152
9mm	6mm	5152	3152
10mm	7mm	5153	3153
10mm	7.5mm	5160	3160
10mm	8mm	5154	3154
12mm	8mm	5154	3154
12mm	9mm	5155	3155
13mm	9mm	5155	3155
14mm	10mm	5156	3156
15mm	11mm	5157	3157
15mm	12mm	5158	3158
16mm	12mm	5158	3158
18mm	14mm	5159	3159

Assorted Box Part No. 3100

Straight Connector



Tube OD	Part No	Pkt No
4mm	5311	3311
5mm	5305	3305
6mm	5322	3322
8mm	5333	3333
9mm	5309	3309
10mm	5344	3344
11mm	5301	
12mm	5355	3355
13mm	5366	3366
14mm	5377	3377
15mm	5388	3388
16mm	5399	3399

Assorted Box Part No. 3300

Unequal Connector



Tube OD	Tube OD	Part No	Pkt No
6mm	8mm	5323	3323
8mm	10mm	5334	3334
10mm	12mm	5345	3345

Tube Nut



Tube OD	Part No
8mm	5123
12mm	5125

Stepped Olive



Tube OD	Part No	Pkt No
4mm	5021	3021
5mm	5095	3095
6mm	5022	3022
8mm	5023	3023
9mm	5099	3099
10mm	5024	3024
11mm	5091	
12mm	5025	3025
13mm	5026	
14mm	5027	3027
15mm	5028	3028
16mm	5029	3029

Assorted Box Part No. 3020

Barrel Olive



Tube OD	Part No	Pkt No
4mm	5031	3031
6mm	5032	3032
8mm	5033	3033
10mm	5034	3034
12mm	5035	3035
13mm	5036	3036
14mm	5037	
15mm	5038	3038
16mm	5039	3039

Assorted Box Part No. 3030

Wade Ferrule



Tube OD	Part No
6mm	5050
8mm	5051
10mm	5052
12mm	5053

Assorted Boxes

For a breakdown of all assorted boxes see section 11

Tee Connector



Tube OD	Part No	Pkt No
4mm	5511	
5mm	5505	
6mm	5522	3522
8mm	5533	3533
9mm	5509	
10mm	5544	3544
12mm	5555	

Elbow Connector



Tube OD	Part No	Pkt No
6mm	5722	
8mm	5733	3733
9mm	5709	
10mm	5744	
12mm	5755	

Stud Elbow



Tube OD	BSPT Thread	Part No	Pack No
4mm	1/8 BSPT	6111	
6mm	1/8 BSPT	6112	
6mm	1/4 BSPT	6142	
8mm	1/4 BSPT	6143	
10mm	1/4 BSPT	6144	4144
12mm	1/4 BSPT	6145	
10mm	1/2 BSPT	6174	
12mm	1/2 BSPT	6175	
15mm	1/2 BSPT	6178	

Straight Stud



Tube OD	BSPT Thread	Part No	Pack No
4mm	1/8 BSPT	5911	
6mm	1/8 BSPT	5912	3912
8mm	1/8 BSPT	5913	3913
6mm	1/4 BSPT	5942	3942
8mm	1/4 BSPT	5943	3943
10mm	1/4 BSPT	5944	3944
12mm	1/4 BSPT	5945	3945
10mm	3/8 BSPT	5964	
12mm	3/8 BSPT	5965	
10mm	1/2 BSPT	5974	
15mm	1/2 BSPT	5978	
16mm	1/2 BSPT	5979	

Tee Connector



Tube OD	Part No
1/8	5411
5/32	5422
3/16	5433
1/4	5444
5/16	5455
3/8	5466
1/2	5477

Stepped Olive



Tube OD	Part No	Pkt No
1/8	5001	3001
5/32	5002	
3/16	5003	3003
1/4	5004	3004
5/16	5005	3005
3/8	5006	3006
1/2	5007	3007
5/8	5008	3008

Assorted Box Part No. 3000

Barrel Olive



Tube OD	Part No	Pkt No
1/8	5011	3011
5/32	5012	3012
3/16	5013	3013
1/4	5014	3014
5/16	5015	3015
3/8	5016	3016
1/2	5017	3017
5/8	5018	
3/4	5019	

Assorted Box Part No. 3010

Tube Nut



Tube OD	Part No
3/16	5103
1/4	5104

Tube Support



Tube Size	Part No	Pkt No
5/16 x 0.212	5164	3164
1/2 x 0.375	5162	3162

Wade Ferrule



Tube OD	Part No
3/8	5046

Assorted Boxes



Brass olives Part No. MSK300

Brass compression metric Part No. MSK330

For a breakdown of all assorted boxes see section 11

Industrial Fittings Brass Compression - Imperial

Stud Elbow



Tube OD	BSPT Thread	Part No	Pkt No
5/32	1/8	6012	
3/16	1/8	6013	4013
1/4	1/8	6014	
5/16	1/8	6015	
1/4	1/4	6044	
5/16	1/4	6045	4045
3/8	1/4	6046	4046
1/2	1/4	6047	
3/8	3/8	6066	
1/2	3/8	6067	
3/8	1/2	6076	
1/2	1/2	6077	
5/8	1/2	6078	

Straight Stud



Tube OD	BSPT Thread	Part No	Pkt No
1/8	1/8	5811	
3/16	1/8	5813	3813
1/4	1/8	5814	
5/16	1/8	5815	
3/16	1/4	5843	
1/4	1/4	5844	3844
5/16	1/4	5845	3845
3/8	1/4	5846	
1/2	1/4	5847	3847
1/4	3/8	5864	
3/8	3/8	5866	3866
3/8	1/2	5876	3876
1/2	1/2	5877	3877
5/8	1/2	5878	

Straight Connector



Tube OD	Part No	Pkt No
1/8	5211	3211
5/32	5222	3222
3/16	5233	3233
1/4	5244	3244
5/16	5255	3255
3/8	5266	3266
1/2	5277	3277
5/8	5288	

Assorted Box Part No. 3200
For a breakdown of all assorted boxes see section 11

Unequal Straight Connector



OD A	OD B	Part No
3/16	1/4	5234
3/16	5/16	5235
1/4	3/8	5246
1/4	1/2	5247
5/16	3/8	5256
5/16	1/2	5257

Elbow Connector



Tube OD	Part No
1/8	5611
3/16	5633
1/4	5644
5/16	5655
3/8	5666
1/2	5677
5/8	5688

Reducing Bush



Female BSPT	Male BSPT	Part No	Pkt No
1/8	1/4	6214	4214
1/4	3/8	6246	4246
1/4	1/2	6247	4247
3/8	1/2	6267	4267
1/2	3/4	6279	4279

Tapered Blanking Plug



BSPT Thread	Part No	Pkt No
1/8	6401	
1/4	6404	4404
3/8	6406	4406
1/2	6407	4407

Female Stud Coupling



Tube OD	Female BSPT	Part No
5/16	1/4	6345

Adaptor



Female BSPP	Male BSPT	Part No
1/8	1/4	6215

Female Tee



Thread Size	Part No	Pkt No
1/8 BSP	0381	
1/4 BSP	0384	MAL024
3/8 BSP	0386	
1/2 BSP	0387	MAL026
3/4 BSP	0389	

Female Socket



Thread Size	Part No	Pkt No
1/8 BSP	0411	MAL007
1/4 BSP	0444	MAL008
3/8 BSP	0466	MAL009
1/2 BSP	0477	MAL010
3/4 BSP	0499	

Plug



Thread Size	Part No	Pkt No
1/8 BSP	0801	MAL017
1/4 BSP	0804	MAL018
3/8 BSP	0806	MAL019
1/2 BSP	0807	MAL020
3/4 BSP	0809	

Hexagon Nipple



Thread Size	Part No	Pkt No
1/8 BSP	0511	MAL012
1/4 BSP	0544	MAL013
3/8 BSP	0566	MAL014
1/2 BSP	0577	MAL015
3/4 BSP	0599	

Male to Female Elbow 90 Degree



Thread Size	Part No	Pkt No
1/8 BSP	0711	
1/4 BSP	0744	
3/8 BSP	0766	MAL033
1/2 BSP	0777	MAL034
3/4 BSP	0799	

Reducing Bush



Female Thread	Male Thread	Part No	Pkt No
1/8 BSP	1/4 BSP	0314	MAL001
1/4 BSP	3/8 BSP	0346	MAL002
1/4 BSP	1/2 BSP	0347	MAL003
1/4 BSP	3/4 BSP	0349	
3/8 BSP	1/2 BSP	0367	MAL004
3/8 BSP	3/4 BSP	0369	
1/2 BSP	3/4 BSP	0379	MAL006
1/2 BSP	1 BSP	0380	

Female Elbow 90 Degree



Thread Size	Part No	Pkt No
1/4 BSP	0644	MAL028
1/2 BSP	0677	MAL030
3/4 BSP	0699	

Reducing Socket



Thread	Thread	Part No
1/4 BSP	3/8 BSP	0446
1/4 BSP	1/2 BSP	0447
3/8 BSP	1/2 BSP	0467
1/4 BSP	3/4 BSP	0449

Malleable Iron Fittings

Reducing Nipple



Thread A	Thread B	Part No	Pkt No
1/4 BSP	3/8 BSP	0546	
1/4 BSP	1/2 BSP	0547	MAL042
3/8 BSP	1/2 BSP	0567	MAL043
1/2 BSP	3/4 BSP	0579	

Male & Female 45 Deg Elbow



Thread Size	Part No
1/2 BSP	0777.45

PTFE Tape



Pack Size	Part No
1	0300

For a full range of valves see section nine

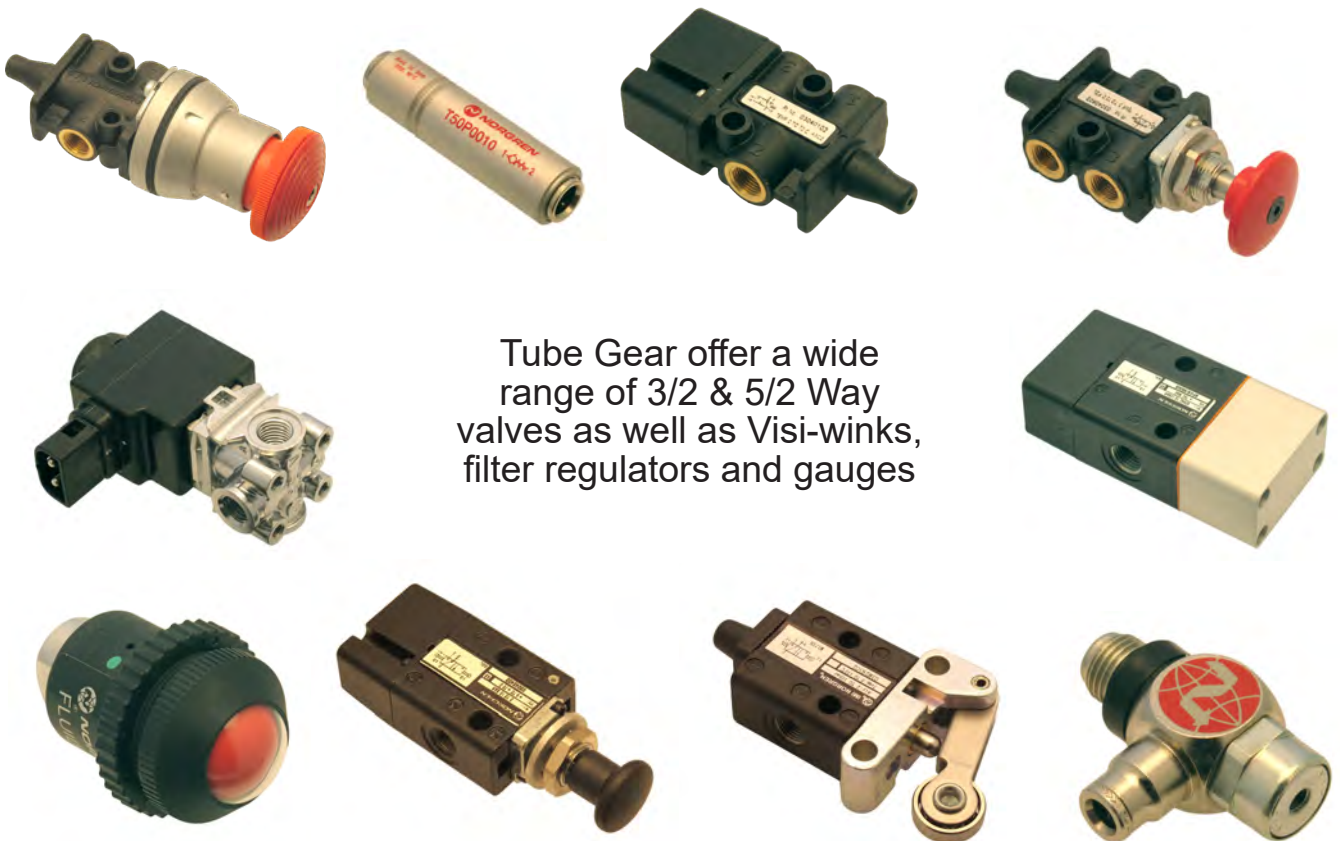

Tube Gear offer a wide range of 3/2 & 5/2 Way valves as well as Visi-winks, filter regulators and gauges

Page 5.2 - 5.5

M/F Brake Pipe Nuts

Tube Gears Wide Range of Steel Brake Pipe Nuts Available with either male or female threads. Suitable for metric and imperial brake pipe

Page 5.7

Bleed Screws

Tube Gears Range of Bleed Screws

Page 5.9

Flaring Tool

The flaring tool can either be mounted in a conventional bench-vice or on its own purpose built base plate.

Page 5.6

3 & 4 Way Connectors

Used for joining multiple brake pipes together

Page 5.8

SAE Fittings

SAE are a type of flare fitting machined with a 37-degree flare seating surface. JIC (Joint Industry Council) fittings are widely used in fuel delivery and fluid power applications, especially where high pressure (up to 10,000 psi) is involved.

Male/Female Brake Pipe Nuts

3/16" Pipe Nuts



Male Pipe Nut
3/16 4.75mm Tube Size

Thread Size	Part No	Pkt No
3/8 x 24 TPI	8001	7001

Application: Most British cars up to 1973
Commercials up to 2 Ton



Male Pipe Nut
3/16 4.75mm Tube Size

Thread Size	Part No	Pkt No
3/8 x 20 TPI	8002	7002

Application: Morris Minor



Male Pipe Nut
3/16 4.75mm Tube Size

Thread Size	Part No	Pkt No
3/8 x 24 TPI TTE Short	8020	7020

Application: Volvo



Male Pipe Nut
3/16 4.75mm Tube Size

Thread Size	Part No	Pkt No
3/8 x 24 TPI TTE Long	8022	7022

Longer Version of 8020



Male Pipe Nut
3/16 4.75mm Tube Size

Thread Size	Part No	Pkt No
7/16 x 24 TPI	8015	7015



Male Pipe Nut
3/16 4.75mm Tube Size

Thread Size	Part No	Pkt No
7/16 x 20 TPI	8019	7019

Application: Fits certain petrol pipe applications & commercial 2-6 ton



Male Pipe Nut
3/16 4.75mm Tube Size

Thread Size	Part No	Pkt No
10 x 1.25mm Long	8003	7003

Application: Fiat 60 on



Male Pipe Nut
3/16 4.75mm Tube Size

Thread Size	Part No	Pkt No
10 x 1.25mm Short	8004	7004

Application: Mazda, Fiat, Datsun 600N 60 on



Male Pipe Nut
3/16 4.75mm Tube Size

Thread Size	Part No	Pkt No
10 x 1.25mm TTE	8023	7023

Application: Honda



Male Pipe Nut
3/16 4.75mm Tube Size

Thread Size	Part No	Pkt No
10 x 1mm Long	8005	7005

Application: Vauxhall

Brake Pipe Fittings

Male/Female Brake Pipe Nuts



Male Pipe Nut
3/16 4.75mm Tube Size

Thread Size	Part No	Pkt No
10 x 1mm TTE Long	8006	7006

Longer Version of 8008



Male Pipe Nut
3/16 4.75mm Tube Size

Thread Size	Part No	Pkt No
10 x 1mm Short	8007	7007

Application: Most British cars 1973 on



Male Pipe Nut
3/16 4.75mm Tube Size

Thread Size	Part No	Pkt No
10 x 1mm TTE	8008	7008

Application: Datsun



Male Pipe Nut
3/16 4.75mm Tube Size

Thread Size	Part No	Pkt No
12 x 1mm	8009	7009

Application: Mk3 Cortina



Female Pipe Nut
3/16 4.75mm Tube Size

Thread Size	Part No	Pkt No
3/8 x 24 TPI	8101	7101

Application: Most British cars up to 1973 Commercials up to 2 Ton



Female Pipe Nut
3/16 4.75mm Tube Size

Thread Size	Part No	Pkt No
10 x 1mm	8102	7102

Application: Most British and European Cars 1973 on



Female Pipe Nut
3/16 4.75mm Tube Size

Thread Size	Part No	Pkt No
12 x 1mm	8107	7107

Application: Fiesta

1/4" Pipe Nuts



Male Pipe Nut
1/4 6mm Tube Size

Thread Size	Part No	Pkt No
7/16 x 20 TPI	8010	7010

Application: Commercials 2-6 ton petrol pipe 60 on



Male Pipe Nut
1/4 6mm Tube Size

Thread Size	Part No	Pkt No
1/2 x 20 TPI	8016	7016

Male/Female Brake Pipe Nuts



Male Pipe Nut
1/4 6mm Tube Size

Thread Size	Part No	Pkt No
1/2 x 20 TPI Short	8021	7021



Male Pipe Nut
1/4 6mm Tube Size

Thread Size	Part No	Pkt No
12 x 1mm	8018	7018



Male Pipe Nut
1/4 6mm Tube Size

Thread Size	Part No	Pkt No
12 x 1mm	8025	7025

Application: Ford Cargo



Male Pipe Nut
1/4 6mm Tube Size

Thread Size	Part No	Pkt No
14 x 1.5mm	8028	



Female Pipe Nut
1/4 6mm Tube Size

Thread Size	Part No	Pkt No
7/16 x 20 TPI	8103	7103

Application: Some petrol pipes



Female Pipe Nut
1/4 6mm Tube Size

Thread Size	Part No	Pkt No
12 x 1mm	8108	7108

Application: Cargo

5/16" Pipe Nuts



Male Pipe Nut
5/16 8mm Tube Size

Thread Size	Part No	Pkt No
1/2 x 20 TPI Short	8012	7012

Application: Power Steering



Male Pipe Nut
5/16 8mm Tube Size

Thread Size	Part No	Pkt No
1/2 x 20 TPI	8011	7011

Application: Commercials 60 On



Male Pipe Nut
5/16 8mm Tube Size

Thread Size	Part No	Pkt No
1/2 x 20 TPI	8024	7024

Application: Petrol Pipe



Male Pipe Nut
5/16 8mm Tube Size

Thread Size	Part No	Pkt No
14 x 1.5mm	8026	7026

Brake Pipe Fittings

Male/Female Brake Pipe Nuts



Female Pipe Nut
5/16 8mm Tube Size

Thread Size	Part No	Pkt No
1/2 x 20 TPI	8104	7104

Application: Commercials 60 On

3/8" Pipe Nuts



Male Pipe Nut
3/8 Tube Size

Thread Size	Part No	Pkt No
5/8 x 18 TPI	8013	7013

Application: Commercials 60 On



Female Pipe Nut
3/8 Tube Size

Thread Size	Part No	Pkt No
5/8 x 18 TPI	8105	7105

Application: Commercials 60 On

10mm Pipe Nuts



Male Pipe Nut
10mm Tube Size

Thread Size	Part No	Pkt No
M16 x 1.5mm	8027	

Application: Late Commercials

1/2" Pipe Nuts



Male Pipe Nut
1/2 12.7mm Tube Size

Thread Size	Part No	Pkt No
3/4 x 16 TPI	8014	

Application: Commercials 60 On



Female Pipe Nut
1/2 12.7mm Tube Size

Thread Size	Part No	Pkt No
3/4 x 16 TPI	8106	7106

Application: Commercials 60 On

3 & 4 Way Connectors



3 Way Connector

Thread Size	Application	Part No	Pkt No
3/8 x 24 TPI	Certain cars with the use of 3 x 8001 - will join 3/16 tube	8303	7303
10 x 1mm	Certain cars with the use of 3 male nuts with 10 x 1mm thread - will join 3/16 tube	8305	7305
12 x 1mm		8308	



4 Way Connector

Thread Size	Application	Part No	Pkt No
3/8 x 24 TPI	Certain cars with the use of 4 x 8001 - will join 3/16 tube	8304	7304
10 x 1mm	Certain cars with the use of 4 male nuts with 10 x 1mm thread - will join 3/16 tube	8306	



Male Connector

Thread Size	Part No	Pkt No
10 x 1mm	8200	7200
Application: Certain cars & with use of 2 x 8102 - will join 3/16" tube.		



Male Connector

Thread Size	Part No	Pkt No
3/8 x 24 TPI	8201	
Application: Certain cars & with use of 2 x 8101 - will join 3/16" tube.		



Female Connector

Thread Size	Part No	Pkt No
10 x 1mm	8302	7302
Application: Certain cars & with use of 2 male nuts 10 x 1mm joins tube		



Female Connector

Thread Size	Part No	Pkt No
3/8 x 24 TPI	8301	7301
Application: fits 1100/1300 & with use of 2 x 8001 - will join 3/16" tube		



Female Connector

Thread Size	Part No	Pkt No
12 x 1mm	8307	7307

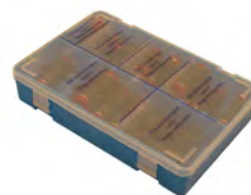

Assorted Boxes

Thread Size	Part No
Male Fittings	7000
Female Fittings	7100

For a breakdown of all assorted boxes see section 11

Bleed Screw



Thread Size	Part No	Pkt No
1/4 x 28 TPI Length 1 1/8	8406	7406

Application: Early Mini front All Mini & 1100 rear Replaces Lockhead 92598

Bleed Screw



Thread Size	Part No	Pkt No
3/8 x 24 TPI Length 1 1/4	8401	7401

Application: Most British cars & commercials up to 2 ton. Lockhead brake drums only replaces Girling 64472444, Lockhead 286696

Bleed Screw



Thread Size	Part No	Pkt No
3/8 x 24 TPI Length 1 3/4	8408	7408

Application: Fits most Girling disc brakes Longer version of 8401

Bleed Screw



Thread Size	Part No	Pkt No
7/16 x 20 TPI Length 1 7/16	8407	7407

Application: Fits most commercials 2-4 ton, replaces Lockhead 12272, Girling 64475409

Bleed Screw



Thread Size	Part No	Pkt No
10 x 1mm Length 1 3/16	8402	7402

Application: Transit front Girling disc & drum, Cortina Mk3, Granada, Allegro. Replaces Lockhead 34486229, Girling 64478635

Bleed Screw



Thread Size	Part No	Pkt No
10 x 1mm Length 1 7/16	8403	7403

Application: Lockhead brakes longer version of 8402 replaces Lockhead 3486-268

Bleed Screw



Thread Size	Part No	Pkt No
10 x 1mm Short	8411	7411

Bleed Screw



Thread Size	Part No	Pkt No
8 x 1.25mm	8405	7405

Application: Fiat, Datsun

Bleed Screw



Thread Size	Part No	Pkt No
7 x 1mm	8404	7404

Application: Most ATE systems, VW, Fiat etc replaces ATE 3.3518-4200

Bleed Screw



Thread Size	Part No	Pkt No
6 x 1mm Long	8410	

Application: Transit 1969 on. On rear drum with single wheel

Bleed Screw



Thread Size	Part No	Pkt No
6 x 1mm Short	8409	7409

Application: Transit 1969 on. All single rear wheel models with Ford cylinders replaces Lockhead 3486-228

SAE Fittings

Straight Connector



Tube OD	Part No
1/2	9277
5/8	9288

Tee Connector



Tube OD	Part No
5/16	9355
3/8	9366

For Cupro Nickel & Copper Brake Pipe see section seven



Soft Copper Tube

This copper pipe has a wall thickness of 0.71mm and can be flared using the Tube Gear Flaring Tool. It is a very supple tube supplied in 25ft coils for use on hydraulics within the maximum working pressures shown next to the part number.



Cupro Nickel Brake Pipe

Manufactured to international standards BS EN 12449. This seamless tube is guaranteed for the life of the vehicle.

The composition of 90% copper and 10% nickel makes the tube more reliable to flare and easier to manipulate when fitting.

Flaring Tool & Accessories



Description	Content	Part No.
Flaring Tool 5 Piece	4.75mm, 3/16, 1/4, 5/16, 3/8	6901
Flaring Tool 5 Piece	4.75mm, 6mm, 8mm, 10mm, 12mm	6901M

The tool can either be mounted in a Conventional bench-vice or on its own purpose built base plate.

Brake tubing is held in split dies which are secured by an over-head locking screw, mounted on a swing clamp.

The mandrill is then positioned in its retainer and advanced into the flaring position by manual operation of the cam lever.

Punch & Die Set

Tube OD	Part No.
3/16	6901.1
5/16	6901.3
6mm	6901.7



Page 6.2

Anti Kink Coils

Manufactured by one of the largest suppliers to most OE truck manufacturers, designed with the UK fleet specifically in mind due to their excellent long term performance and cost benefits.

Page 6.4

Air Brake Hose

This Rubber Air Brake is manufactured to the Airbrake Standard SAE J1402 for Imperial sizes and DIN 74310 for Metric sizes

Page 6.6 - 6.7

Nylon Tubing

All Tube Gear Nylon is Manufactured and printed to the latest Air Brake Standards and is suitable for use with Air, Water, Diesel and many other chemicals.

Page 6.2 - 6.3

Unicoils

These coils have a swivel thread on both ends and with the use of a range of Adaptors, can be used to make a number of different applications for MAN, DAF, Iveco, Scania, Renault & Volvo Trucks.

Page 6.4 - 6.5

Pipe Components

We have a full range of chasis clips, pipe clips, cable ties, worm drive clips & O clips, available in a full range of sizes to complement our air brake & nylon tubing

Page - 6.7

Tube Cutters

Tube Gear supply high quality plastic and steel tube cutters, these cutters are good up to 22mm nylon tubing.

Compact Coil & Unicoils

Compact Anti-Kink Coils

As well as the security of these coils being manufactured by one of the largest suppliers to most OE truck manufacturers, these have been designed with the UK fleet specifically in mind. Many of the larger UK supermarket fleets are now specifying these coils to be supplied above all others due to their excellent long term performance and cost benefits.

These coils have a 40mm ID coil diameter with a 4m working length. They meet DIN standards 74323 and 74324 with a burst pressure that exceeds 57 bar at 23°C and a safety factor of 3 at 70°C. These coils have the strength of Polyamide with the flexibility of Polyurethane and are benchmarked as best in their class.



Thread A	Thread B	Colour	Working Length	Turns	Part No.
M18 x 1.5	M18 x 1.5	Black Tube with Yellow Tail	4 Metre	32 Turn	2127
M18 x 1.5	M18 x 1.5	Black Tube with Red Tail	4 Metre	32 Turn	2128

Unicoils

These coils are manufactured out of Super Polyurethane instead of Polyamid. Polyamid 11-12, a special compound of polyurethane has large advantages: Very good recovery from kinking Longer working Lengths, High tensile elasticity, Better resistance against oil, petrol, ozone and UV, High flexibility at low temperatures, Very good abrasion and rupture resistance (no fracture at the connections) Within a temperature range of -40°C up to 70°C, our material has the characteristics of rubber. Working pressure 10 BAR, bursting pressure 42 BAR at 20°C. Tested by TÜV Germany according to: ISO 7375/2 198, ISO 7628/2 1998, DIN 73378/02 '96, DIN 74310-2/12 '93, DIN 74323/04 '91 and DIN 74324/02 '96



Coil Diameter 50mm ID X 75mm OD

Thread A	Thread B	Colour	Working Length	Part No.
M18x1.5 Fem	M18x1.5 Fem	Black tube With Red Tail	3 Metre	2116
M18x1.5 Fem	M18x1.5 Fem	Black Tube With Yellow Tail	3 Metre	2117
M22x1.5	M22x1.5	Black tube With Red Tail	3 Metre	2113
M22x1.5	M22x1.5	Black Tube With Yellow Tail	3 Metre	2114
M18x1.5 Fem	M18x1.5 Fem	Black Tube With Yellow Tail	4 Metre	2137
M18x1.5 Fem	M18x1.5 Fem	Black tube With Red Tail	4 Metre	2138
M18x1.5 Fem	M18x1.5 Fem	Black Tube With Yellow Tail	4.5 Metre	2118
M18x1.5 Fem	M18x1.5 Fem	Black tube With Red Tail	4.5 Metre	2119
M22x1.5	M22x1.5	Black tube With Red Tail	4.5 Metre	2133
M22x1.5	M22x1.5	Black Tube With Yellow Tail	4.5 Metre	2134

Unicoils

Coil End Adaptor



Thread A	Thread B	Part No
M18 x 1.5	1/4 NPT	2019

Coil End Adaptor



Thread A	Thread B	Part No
M18 x 1.5	1/2 BSP	2021

Coil End Adaptor



Thread A	Thread B	Part No
M18 x 1.5	M22 x 1.5	2022

Coil End Adaptor



Thread A	Thread B	Part No
M18 x 1.5	M16 x 1.5	2023

Coil End Adaptor (34mm Long)



Thread A	Thread B	Part No
M18 x 1.5	M18 x 1.5	2024

Coil End Adaptor (34mm Long)



Thread A	Thread B	Part No
M18 x 1.5	M16 x 1.5	2025

Assorted Box of End Fittings - Part No. 2026
For a breakdown of all assorted boxes see section 11

Air Coil Handles

These handles are ergonomically designed to assist with grip when connecting and disconnecting Air Coils especially in poor conditions.



Female Thread	Male Thread	Colour	Part No.
M16 x 1.5	M16 x 1.5	Red & Yellow Handles (Pair)	2029

Rubber Air Hose

Imperial Air Brake Hose

This braided rubber hose is manufactured to the air brake standard SAE J1402, has a burst pressure of 62 bar and a working pressure of 15.5 bar



Hose ID	10 Metre Coil	15 Metre Coil	20 Metre Coil	50 Metre Coil	O Clip	Worm Drive
3/8	1696		1706	1706.50	2010	2033
1/2	1697		1707	1707.50	2012	2035
5/8		1708				2036

Metric Air Brake Hose

Manufactured to DIN 74310 standard this hose has a burst pressure of 54 bar and working pressure of 18 bar



Hose ID	Hose OD	10 Metre Coil	50 Metre Coil	O Clip	Worm Drive
13mm	25mm	1713	1713.50	2014	2035

Chassis Clips



Suits Tube OD	Beam Thickness	Part No.
6 - 7mm	2 - 4mm	2070
7 - 9mm	2 - 4mm	2071
10 - 11mm	2 - 4mm	2072
12 - 14mm	2 - 4mm	2073
6 - 7mm	4 - 7mm	2075
7 - 9mm	4 - 7mm	2076
10 - 11mm	4 - 7mm	2077
12 - 14mm	4 - 7mm	2078
15 - 18mm	4 - 7mm	2079

Pipe Clips



Suits Tube OD	Fixing Screw	Part No.
6mm	M6	2050
8mm	M6	2051
10mm	M6	2052
12mm	M6	2053
15mm	M6	2054
16mm	M6	2055
18mm	M6	2056
25mm	M6	2059
32mm	M6	2057

Strap Width 16mm

Cable Ties



Length	Width	Part No.
100mm	2.5mm	2060
140mm	3.6mm	2061
200mm	4.8mm	2062
300mm	4.8mm	2063
370mm	4.8mm	2064
430mm	4.8mm	2065
370mm	7.8mm	2066

Sold In Packs Of 100

Worm Drive Clips



Tube OD mm	Tube OD Inch	Band Width	Reference	Part No.
8 - 12mm	5/16 - 1/2	9mm	OOO	2031
10 - 16mm	3/8 - 5/8	9mm	MOO	2032
12 - 22mm	1/2 - 7/8	9mm	OO/O	2033
16 - 27mm	5/8 - 1 1/16	9mm	O	2034
16 - 27mm	5/8 - 1 1/16	12mm	OX	2035
20 - 32mm	3/4 - 1 1/4	12mm	1A	2036
25 - 40mm	1 - 1 5/8	12mm	1/1X	2038
32 - 50mm	1 1/4 - 2	12mm	2A	2039
40 - 60mm	1 5/8 - 2 3/8	12mm	2/2X	2041
50 - 70mm	2 - 2 3/4	12mm	3	2042
60 - 80mm	2 3/8 - 3 1/8	12mm	3X	2043
70 - 90mm	2 3/4 - 3 1/4	12mm	4	2044
80 - 100mm	3 1/8 - 4	12mm	4X	2045
100 - 120mm	4 - 4 3/4	12mm	5	2046
120 - 140mm	4 3/4 - 5 1/2	12mm	6X	2047
140 - 160mm	5 1/2 - 6 1/4	12mm	7	2049

Assorted Box Part No. 2030A

For a breakdown of all assorted boxes see section 11

O Clips



Hose OD mm	Hose OD Inch	Part No.
5 - 7mm	1/4	2002
7 - 9mm	5/16	2003
9 - 11mm	3/8	2004
10 - 12mm	7/16	2005
11 - 13mm	1/2	2006
13 - 15mm	9/16	2007
15 - 18mm	5/8	2009
17 - 20mm	3/4	2010
20 - 23mm	7/8	2012
23 - 27mm	1	2014

Assorted Box Part No. 2000

Includes O Clip Pincers Part No. 6902

For a breakdown of all assorted boxes see section 11

Worm Drive Screw Driver



Part No. 2030

O Clip Pincers



Part No. 6902

Metric nylon

All Tube Gear Nylon is Manufactured and printed to the latest Air Brake Standards and is suitable for use with Air, Water, Diesel and many other chemicals.

The burst and working pressures shown are applicable at 23°C. We recommend using a tube support on tube sizes of 6mm O.D. and above where it's not an integral part of the fitting being used.



15 Metre Coils

Tube OD	Tube ID	Black Part No	Red Part No	Yellow Part No	Blue Part No	Green Part No	Burst Pressure (Bar)	Working Pressure (Bar)
4mm	2mm	1211					136	45
6mm	4mm	1221	1223		1225	1226	82	27
8mm	6mm	1231	1233	1234	1235		57	19
10mm	7mm	1241H	1243H	1244H			68	22
10mm	7.5mm	1241M	1243M	1244M	1245M		57	19
10mm	8mm	1241	1243	1244	1245		45	15
12mm	9mm	1251	1253	1254	1255		57	19
14mm	10mm	1271					63	21
15mm	12mm	1281					45	15
16mm	12mm	1301					57	19
18mm	14mm	1291					65	21

30 Metre Coils

Tube OD	Tube ID	Black Part No	Red Part No	Yellow Part No	Blue Part No	Green Part No	Orange Part No	Burst Pressure (Bar)	Working Pressure (Bar)
4mm	2mm	1311						136	45
6mm	4mm	1321	1323	1324	1325	1326		82	27
8mm	6mm	1331	1333	1334	1335	1336		57	19
10mm	7mm	1341H	1343H	1344H		1346H		68	22
10mm	7.5mm	1341M	1343M	1344M	1345M	1346M	1347M	57	19
10mm	8mm	1341	1343	1344	1345	1346		45	15
12mm	9mm	1351	1353	1354	1355			57	19
14mm	10mm	1371						63	21
15mm	12mm	1381						45	15
16mm	12mm	1401	1403					57	19
18mm	14mm	1391						65	21

Available in 500 metres using a .500 extension, i.e. 1321.500 is a 500 drum of 6mm x 4mm black nylon
 Available in 300 metre lengths. Available in 200 metres. Available in 100 and 200 metres.

This flexible nylon tubing is manufactured from heat and light stabilised nylon 11 + 12 and is suitable for use with air, water, diesel and many other chemicals. The burst and working pressures shown are applicable at 23°C.

We recommend using a tube support on tube sizes of 1/4" O.D. and above where it's not an integral part of the fitting being used.



30 Metre Coils

Tube OD	Tube ID	Black Part No	Red Part No	Yellow Part No	Burst Pressure (Bar)	Working Pressure (Bar)
1/4	0.170	1141			102	25
5/16	0.212	1151			102	25
3/8	0.265	1161	1163	1164	88	22
1/2	0.375	1171			75	19

Plastic Tube Cutters



Description	Part No.
Cutters - cutting up to 13mm 1/2 Tube	6910
Spare Blade	6911
Tube Cutter Packet	PIF106

Metal Tube Cutters



Description	Part No.
Cutters - will cut up to 22mm Tube	6914
Spare Blade	6915

Page 7.2

Cupronickel Brake Pipe

Manufactured to international standards BS EN 12449. This seamless tube is guaranteed for the life of the vehicle. The composition of 90% copper and 10% nickel makes the tube more reliable to flare and easier to manipulate when fitting.

Page 7.2

Copper Brake Pipe

This copper pipe has a wall thickness of 0.91mm and can be flared using the Tube Gear Flaring Tool. It is a very supple tube supplied in 25ft coils for use on hydraulics.

Page 7.3

Flaring Tools

The tool can either be mounted in a conventional bench-vice or on its own purpose built base plate.

Page 7.4

PVC Tubing

This clear tubing is reinforced with polyester fibre braid and offers exceptional chemical and physical properties. It is flexible and lightweight as well as being resistant to most acids and alkalis

Page 7.4

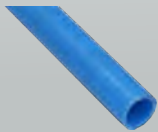
Rigid Nylon Tube

For use in air ring mains this blue unplasticised nylon 12 pipe is available in packs of 5 x 3 metre lengths.

Page 7.5

Rubber Hose

We have a range of rubber fuel hose, manufactured to SAE J30 R6 designed to carry fuels such as petrol and diesel. Heater hose reinforced suitable for vehicle water systems. Industrial Air Hose resistant to wear and

Page 7.5 - 7.6

Work Shop Coils

These air coils are made to the highest standard, they provide ease of use when attached to tools, helps protect tool ends and leaves the work area clear of entanglements and trip hazards. A range of hose sizes, working lengths and colours are available.

Cupronickel & Copper Brake Pipe

Cupronickel Brake Pipe

Manufactured to international standards BS EN 12449. This seamless tube is guaranteed for the life of the vehicle.

The composition of 90% copper and 10% nickel makes the tube more reliable to flare and easier to manipulate when fitting.



Size OD	MWP (Bar)	Wall Thickness	Coil Length (ft)	Part No.
3/16	214	0.71mm	25	1500
1/4	155	0.71mm	25	1501
5/16	120	0.71mm	25	1502
3/8	100	0.71mm	25	1503
1/2	75	0.71mm	25	1504
6mm	150	0.71mm	25	1501M
8mm	120	0.71mm	25	1502M
10mm	90	0.71mm	25	1503M
12mm	75	0.71mm	25	1504M

Soft Copper Tube

This copper pipe has a wall thickness of 0.71mm and can be flared using the Tube Gear Flaring Tool. It is a very supple tube supplied in 25ft coils for use on hydraulics within the maximum working pressures shown next to the part number.



Size	MWP (Bar)	Wall Thickness	Coil Length (ft)	Part No.
3/16	258	0.71mm	25	1510
1/4	184	0.71mm	25	1511
5/16	143	0.71mm	25	1512
3/8	117	0.71mm	25	1513
4mm	258	0.71mm	25	1510M
6mm	197	0.71mm	25	1511M
8mm	143	0.71mm	25	1512M
10mm	117	0.71mm	25	1513M
12mm	110	0.71mm	25	1514M

Hydraulic

Flaring Tools & Accessories

Flaring Tool & Accessories

Description	Content	Part No.
Flaring Tool 5 Piece	4.75mm, 3/16, 1/4, 5/16, 3/8	6901
Flaring Tool 5 Piece	4.75mm, 6mm, 8mm, 10mm, 12mm	6901M

The tool can either be mounted in a conventional bench-vice or on its own purpose built base plate.

Brake tubing is held in split dies which are secured by an over-head locking screw, mounted on a swing clamp.

The mandrill is then positioned in its retainer and advanced into the flaring position by manual operation of the cam lever.



Punch & Die Sets

Tube OD	Part No.
3/16	6901.1
5/16	6901.3
6mm	6901.7



PVC, Rigid & Rubber Tubing

Clear Braided PVC Tubing 30 Metre Coils



Tube ID	Part No	Max Working Pressure (Bar)	O Clip	Wormdrive Clip
3/16	1913	20	2004	2031
1/4	1914	17	2006	2031
5/16	1915	13	2007	2032
3/8	1916	10	2009	2032
1/2	1917	9	2010	2033
5/8	1918	8	2014	2035
3/4	1919	7		2036
1	1920	5		2038

This clear tubing is reinforced with polyester fibre braid and offers exceptional chemical and physical properties. It is flexible and lightweight as well as being resistant to most acids and alkalis

Clear PVC Tubing 30 Metre Coils



Tube ID	Wall Thickness	Part No	O Clip	Wormdrive Clip
3/16	1/16	1933	2003	
1/4	1/16	1934	2004	
5/16	1/16	1935	2006	2031
3/8	1/8	1946	2009	2032
3/4	1/8	1949		

Windscreen washer tube 4mm ID 6mm OD. Part No. 1951

This exceptionally clear PVC tubing has a wide range of applications for low pressure work. It is resistant to oils, grease and solvents. Supplied in 30 metre coils.

Rubber Fuel Hose 15 Metre Coils



Tube ID	Part No.	O Clip	Wormdrive Clip
3/16	1853	2006	2031
1/4	1854	2007	2031
5/16	1855	2007	2032
3/8	1856	2009	2032

Manufactured to SAE J30 R6, this hose is specifically designed to carry fuels such as petrol and diesel.

Rigid Nylon Tubing



Size (mm)	Part No
22 x 18	1408

For use in air ring mains this blue unplasticised nylon 12 pipe is available in packs of 5 x 3 metre lengths

Pipe Clips



Size (mm)	Part No
15	2727
22	2728

Sold in packs of 10

Heater Hose 10 Metre Coils



Tube ID	Part No	O Clip	Wormdrive Clip
1/2	1807	2012	2033
5/8	1808	2014	2035
3/4	1809		2036
1	1810		2038

This reinforced rubber hose has a maximum working pressure of 10 bar and is suitable for vehicle water systems.

Industrial Hose 15 Metre Coils



Tube ID	Part No	O Clip	Wormdrive Clip
1/4	1814	2007	2032
5/16	1815	2007	2032
3/8	1816	2009	2032
1/2	1817	2012	2035

This double braided rubber hose has a maximum working pressure of 15 bar and is resistant to wear and greasy floors making it ideal for workshop use.

Workshop / Forecourt Coils

These air coils are made to the highest standards using 8mm x 1mm nylon tube. The 1/4" BSP female end fittings have anti-kink springs locked on by a plastic collar. The burst pressure is 51 bar and the working pressure is 13 bar.



Working Length	Thread	Part No.
25ft	1/4 BSP Male	2351
50ft	1/4 BSP Female	2352

Workshop / Forecourt Coils

PU Coiled Air Hose Assemblies overcome the limitations of nylon, such as kinking, abrasion and resistance to oils and increases the effective working temperature range. The use of PU allows use in any direction with the elimination of hose kinks aiding air flow. It also provides ease of use when attached to tools, helps protect tool ends and leaves the work area clear of entanglements and trip hazards. A range of hose sizes, working lengths and colour is available.

- Polyurethane (PU) material
- Nickel plated 360° swivel fittings
- 200m straight ends with spring guard
- Hose recoils to a fraction of it's working length
- Range of hose sizes, working lengths and a choice of colour



Part No.	Hose ID	Hose OD	Hose Length	Hose Fittings	Hose Colour
2340	6.5mm	10mm	7.5m	1/4 BSP Swivel	Red
2341	6.5mm	10mm	7.5m	1/4 BSP Swivel	Blue

Page 8.2 - 8.3

Grease Nipples

We have straight, angled and extended grease nipples both standard and button connections, metric and imperial threads to cover 99% of the UK vehicle market. We also supply them in a universal assorted box range.

Page 8.6 - 8.9

Garage Equipment

We have a wide range of garage equipment, from spray bottles, drum taps, manual and electrical drum pumps and delivery systems for all types of oils and lubricants including Adblue.

Page 8.11

Tube Cutters

Tube cutters are available in both metal and plastic versions, ideal for cutting our range of nylon tubing.

Page 8.4 - 8.5

Grease Equipment

To complement our grease nipple range we also have a range of grease nipple connectors and delivery systems, both manual and automatic for grease tubes and barrels.

Page 8.10

Test Kits

This air brake and suspension test kit, comes with a 20 bar glycerine air pressure gauge 0-20 bar, 2 metres of hose c/w test point adaptors, 2 coupling testers and a small wire brush.

Page 8.11

Flaring Tool

We have a large range of test points in metric and imperial sizes, ideal for a range of different applications, like our air tank range in section 10.

Grease Nipples

Straight Grease Nipple



Thread	Part No	Pkt No
1/8 BSP	8501	7501
1/4 BSF	8502	7502
5/16 BSF	8503	7503
1/4 UNF	8504	7504
1/4 BSP	8506	7506
6mm x 1	8507	7507
8mm x 1	8508	7508
8mm x 1.25	8509	7509
10mm x 1	8510	7510
10mm x 1.5	8511	7511

45 Deg Grease Nipple



Thread	Part No	Pkt No
1/8 BSP	8520	7520
1/4 BSF	8521	
5/16 BSF	8529	
1/4 UNF	8522	
1/4 BSP	8523	
6mm x 1	8524	
8mm x 1	8525	7525
8mm x 1.25	8526	7526
10mm x 1	8527	7527
10mm x 1.5	8528	7528

90 Deg Grease Nipple



Thread	Part No	Pkt No
1/8 BSP	8512	7512
1/4 BSF	8513	
5/16 BSP	8514	
1/4 UNF	8515	
1/4 BSP	8516	
6mm x 1	8517	7517
8mm x 1.25	8518	
10mm x 1	8519	
10mm x 1.5	8537	

Button Hook-on Grease Nipple



Thread	Part No
1/8 BSP	8530
1/4 BSP	8531
3/8 BSF	8532

67 Deg Grease Nipple



Thread	Part No
1/8 BSP	8541
1/4 BSF	8542

Straight Extended Grease Nipple



Thread	Part No	Pkt No
1/4 UNF	8505	7505

Grease Nipple Extension



Thread Male & Female	Extension Length	Part No
1/8 BSP	1"	8540.1

Assorted Box



Description	Part No
Assorted Box	7500

For a breakdown of all assorted boxes see section 11

Battery Plate Adaptor



Thread	OD	Part No
1/8 BSP	1/4	8544

Slide-on Knuckle Connector



Thread	Part No
1/8 BSP	6906

Push-on Connector



Thread	Part No	Pkt No
1/8 BSP	6907	8907

Hook-on Connector



Thread	Part No
1/8 BSP	6913

Slide-on Connector



Thread	Part No
1/8 BSP	6918

Quick Release Coupler



Thread	Part No
1/8 BSP	6909

Grease Flexi Hose



Thread BSP	Length	Type	Part No
1/8	12"	Nylon	6905
1/8	18"	Nylon	6905.18
1/8	24"	Rubber	6905.24R

Linch Pin with O ring



Size	Part No
6mm	6990
8mm	6991
11mm	6992

Ring wire dia 3.5mm. Bright zinc plate and gold passivate finish.

Cotter R Clip



Size	Part No
3mm	6980
3.5mm	6981
4mm	6982
5mm	6983
6mm	6984

Single coil 'R' grips with bright zinc plate finish.

Grease Equipment

Side Lever Grease Gun

Develops up to 10,000 psi, to DIN 1283 Grease capacity 500cc bulk filler, 400g grease cartridge.



Size	Description	Part No
400g	With Cast Iron Head	6904

Grease Bucket Pump

Pressure exceeds 6000 psi. Supplied with rubber-edged follower plate to reduce grease vortexing and cavitation in the container, 1.5m high pressure rubber flexihose and 4 jaw coupler.



Size	Description	Part No
12.5kg	For Grease Keg	6908

Auto Chassis Lube Filler Pump

High volume output for filling auto chassis lubrication system reservoirs. Supplied with 1.5m of 3/8" (9mm) hose and 1/4" BSP male end fitting for your quick release connector and lid. Follower plate supplied as an optional extra if required.



Drum Size	Description	Part No
12.5kg	Complete with female fittings	6937

Dry Brake Coupling



Female Thread	Part No
1/4 BSP	6945

Airomatic Greasing Systems - Technical Data

Airomatic Greasing Systems - Technical Data

Airomatic greasers are suitable for use with multipurpose greases to NLGI No 2 specification made with light to medium base oil viscosities. However, with greases for special applications which have high viscosity base oils and/or special additives, problems may be encountered. If so, the question of pumpability should be referred to the appropriate grease manufacturer.

Power source is by highly efficient trouble free airo-motors of proven design. Operating pressure 3.5 bar minimum to 8 bar maximum. For extended operating life we recommend pressures of 6 bar in conjunction with filtered and lubricated air lines.

Safety Warning: 100:1 ratio not to be used with hand held equipment

Note: Ensure only air operated grease flexihoses are used with this equipment

Airomatic Greasing Systems - Technical Data

Pump complete with lid, follower plate, 4m hose and accessories ready for fitting to your keg, complete with Air Management System and Trolley.

The greaser has a ratio of 50:1 with a maximum line pressure of 400 bar. The delivery capacity is 0.7kg/min and the shank length is 75cm. Its external shank diameter is 28mm and is suitable for kegs of 50-60 kilos. The air inlet/grease outlet is 1/4 BSP.F. This is a hand held application.



Size	Part No
50kg	6938

Grease Control Gun

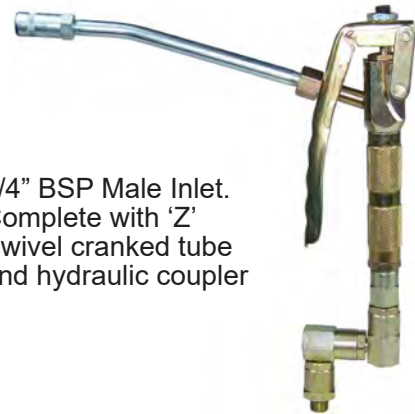

1/4" BSP Male Inlet.
Complete with 'Z'
Swivel cranked tube
and hydraulic coupler

Size	Part No
1/4 BSP	6939

Garage Equipment

Plastic Sprayer Bottles

With
Chemical
Resistant
Head



Size	Part No
600cc	6935

Brake Cleaner & Chemical
Pressure Sprayer



Size	Part No
1 Ltr	6936

Flexi-spout Oil Measure



Heavy Duty
Polyethylene

Size	Part No
5 Litre	6952

Flexi-spout Funnel - Anti Spill



Size	Part No
6"	6947
9"	6948

Drum Tap - Polyethylene



Size	Part No
1 Litre	0146

Aero HDPE Drum Tap



Thread	Part No
DIN61	0147

Dispensing tap for containers and drums are perfectly suitable for simple, clean and quick refilling of fluids without gurgling. The outstanding flow properties are based on the patented ventilation system. suitable for plastic containers and bottles

Lever Drum Pump

Higher output lever action. Oil and Anti-freeze pump. 400cc per stroke (approx.) Extra strong Telescopic tube. Anti drip filter cap. Brass piston rings. Not to be used with Chemicals, Petrol, other Corrosive or Volatile Liquids unless specified. Do not test pumps with water. Keep pumps well oiled when not in use.



Size	Description	Part No
400cc	For 205 ltr Drum	6940

Submersible 12v Electric Pump Kit

Part No.	6942
Voltage	12
Free Flow Ltr/min	18
Pressure PSI	15
Head Mtrs	11
Current Max Amps	4.5
Length cm	14.5
Dia cm	5.4
Weight Kilos	0.6
Body	PP
Cable Length (with Battery Clips)	4
Hose Dia Mtr	1/2
Outlet Hose Mtr	3
Seals & O rings	NBRNBR



Suitable for diesel, various chemicals, fresh and dirty water. Ideally suitable for on-site diesel refuelling of contractors and agricultural plant. Efficient and easy to clean filters. Pump can be run continuously for periods up to 1 hr. Pump must not be allowed to run dry. Not to be used with petrol or liquids within flash point range -20°C to +80°C. Keep submerged when used with water even when not in use.

Automatic Shut Off Nozzle

This product will not operate with gravity feed systems. 80 Ltr/min max output (unless stated). Nozzle shuts off automatically when liquid covers the vent hole at the end of the spout. For use with Diesel/Gas Oil. 1" BSP swivel inlet. Pumps will deliver a minimum of 13 Ltr/min to activate 'shut-off' mechanism. Built in check valve, low-flow 'shut-down', simple lever catch. Maximum pressure 3 bar.



Size OD	Description	Part No
25mm	80 ltr / min	6944

Garage Equipment

12 & 24 Volt Electrical Pump Dispensing Kit, (Not Self Priming)

Part No.	6943
Voltage	12 / 24
Watts	190/520
Amps	16/22
RPM	1400/2200
Flow Rate of Pump Ltr/min	45
Maxx Run Time Per hr (min)	30/10
Max Head (m)	12
Max Suction	2.5
Protection (P)	54
Weight (kg)	7
Ports (BSP)	3/4
Bar	0.3



Diesel pump suitable for pumping class 'C' fuels (not petrol or liquids within flash point range - 20°C to +80°C), with re-circulation by-pass and suction hose end filter.

Note: Valid flow rates with manual nozzles. Flow rates are reduced by approximately 2 Lpm when using a meter. Flow rates are reduced by 14% through automatic nozzles.

Chemical Barrel Syphon Pump

Suitable for petrol, paraffin, diesel, insecticides, distilled water, detergents etc.



Size	Description	Part No
205 Ltr	Suction tube length 850mm	6960

Adblue & Chemical Piston Barrel Pump



Size	Description	Part No
205 Ltr	To suit 205 Ltr barrels	6961

Drum Pump

C/W DIN61 Adaptor Hose & Nozzle to suit 20/25 Ltr barrels.



Size	Part No
20/25 Ltr	6941

Adblue rotary barrel hand pump
c/w 3m hose for 205 litre drums

Thread	Part No.
2 BSP	6962

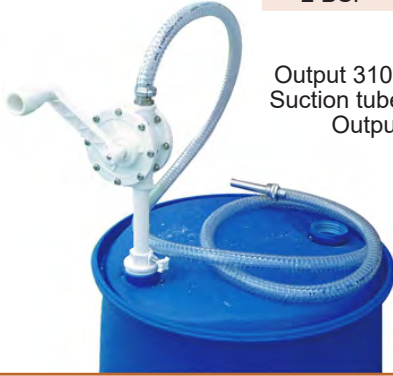

Output 310ml per revolution.
Suction tube length 1000mm,
Output Dia:25mm

Adblue manual nozzle c/w 3/4 bsp swivel adaptor



Flow Rates	Description	Part No.
Upto 80 litres	Impact resistant ABS housing	6963

Adblue IBC gravity feed kit c/w 4m delivery hose



The kit contains an impact resistant manual nozzle, Flow rates upto 80 litres per minute

Female Thread	Flow Rates	Part No.
DIN61	Upto 80 litres	6964

Adblue automatic stainless steel nozzle
c/w 3/4 bsp swivel adaptor



Flow rates upto 70 litres per minute, automatic shut off

Female Thread	Flow Rates	Part No.
3/4 BSP	Upto 80 litres	6965

Air Brake and Suspension Test Kit

(Part No. 0116)

Replacement Gauges

Gauge glycerine filled
Rubber Backed 4" 20 bar,
comes in kit 0116

Part No. Z0117



PURPOSE:

To enable the Air Pressure in the System to be identified at a given Test Point

To enable the Air Pressure from Truck to Trailer to be determined

CONTENTS:

Gauge: 0-20 Bar Rubber Backed Glycerine Air Pressure Gauge

2 Metres of Hose c/w Test Point Adaptors

2 Coupling Testers

Small Wire Brush

OTHER BENEFITS:

Air Suspension Calibration

Balancing Air Pressure to Brake Chambers

Identification of Faulty Valves

Pre-MOT Testing

Testing Load Sensing Valves

Flaring Tool & Accessories

Description	Content	Part No.
Flaring Tool 5 Piece	4.75mm, 3/16, 1/4, 5/16, 3/8	6901
Flaring Tool 5 Piece	4.75mm, 6mm, 8mm, 10mm, 12mm	6901M



The tool can either be mounted in a conventional bench-vice or on its own purpose built base plate.

Brake tubing is held in split dies which are secured by an over-head locking screw, mounted on a swing clamp.

The mandrill is then positioned in its retainer and advanced into the flaring position by manual operation of the cam lever.

Worm Drive Screw Driver



Part No.	Part No.
Screw Driver	2030

Plastic Tube Cutters



Description	Part No.
Cut up to 13mm Tube	6910
Spare Blade	6911
Tube Cutter Packet	PIF106

Metal Tube Cutters



Description	Part No.
Cut up to 22mm Tube	6914
Spare Blade	6915

Page 9.2 - 9.15

3/2, 5/2, 5/3 Valves

A selection of high performance spool and poppet type directional control valves used in a variety of vehicle pneumatic systems.

Page 9.15 - 9.16

Visi Winks

Visi-winks are a visual aid for drivers to identify while operating machinery, fitted OEM on a range of trucks and tankers, with different colour coded options available.

Page 9.16 - 9.17

Pressure Regulators

To control outlet pressure to a fixed value when air flow increases or decreases.

Page 9.17 - 9.18

Non-Return Valves

Simple reliable in-line design allowing free flow in one direction.

Page 9.18

Pilot Blocking Valves

Essentially a pilot operated check valve allowing air flow in both directions if a pilot pressure is applied. When pilot pressure is removed flow only occurs in one direction.

Page 9.19 - 9.20

Exhaust Filters and Silencers

To prevent the ingress of dirt and reduce the noise levels of pneumatic equipment.

Page 9.21

Filter Regulators

Combining a filter with an adjustable pressure regulator to eliminate problems due to poor air quality.

Valves

Description	3/2 Pilot/Spring Valve
Part No	VAL605
Cross Ref	030601M2
Main Threads	M14 x 3
Pilot Thread	M10 x 1
Bar	2 to 10
Working Temp	0 to 70°C Max

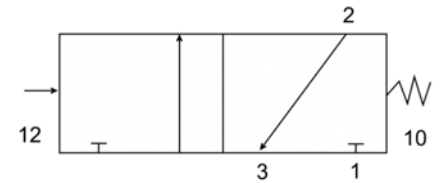

Description	3/2 Pilot/Spring Valve
Part No	VAL604
Cross Ref	03060102
Main Threads	1/4 BSP x 3
Pilot Thread	1/8 BSP x 1
Bar	2 to 10
Working Temp	0 to 70°C Max

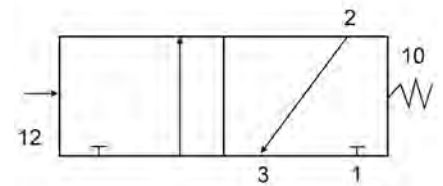

Description	3/2 Pilot Spring
Part No	VAL801
Cross Ref	338-035
Main Threads	1/8"
Pilot Thread	1/8"
Bar	0.9 to 10 bar
Working Temp	0 to 60 degree C

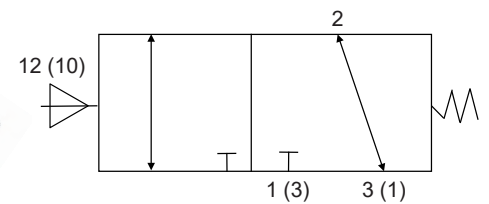

Description	3/2 Pilot Spring Valve
Part No	VAL804
Cross Ref	334-035
Main Threads	1/4"
Bar	0.9-10 bar
Working Temp	0 to 60 degree C

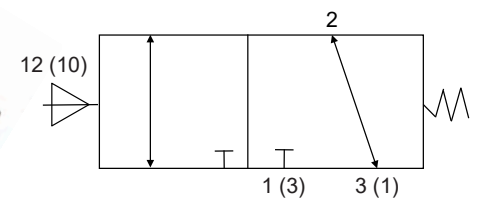

Description	3/2 Pilot/Spring Valve
Part No	VAL606
Cross Ref	SPGB/26272
Main Threads	M14 x 3
Pilot Thread	M10
Bar	2 to 10
Working Temp	0 to 80°C Max

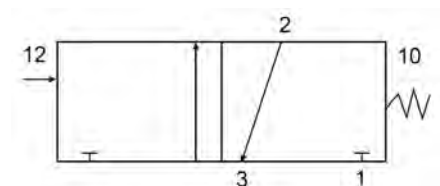

Description	3/2 Pilot Spring Valve
Part No	VAL603
Cross Ref	03040102
Main Threads	1/8 BSP x 3
Pilot Thread	1/8 BSP x 1
Bar	0 to 10
Working Temp	0 to 70°C Max

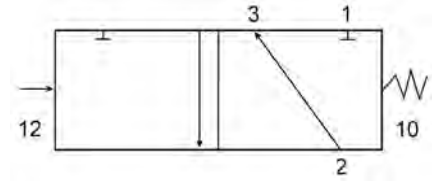

Description	3/2 4 Bar Pilot Spring Valve
Part No	VAL647
Cross Ref	SPGB/35004
Main Threads	1/4 BSP x 3
Pilot Thread	1/8 BSP x 1
Bar	4 to 10
Working Temp	0 to 70°C Max

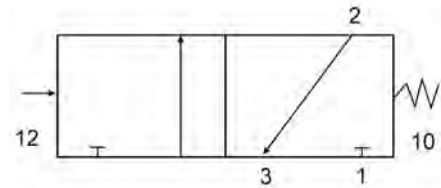

Description	3/2 2 Bar Pilot Spring Valve
Part No	VAL655
Cross Ref	SPGB/35003
Main Threads	1/4 BSP x 3
Pilot Thread	1/8 BSP x 1
Bar	93 Vac to 10 Bar
Working Temp	0 to 70°C Max

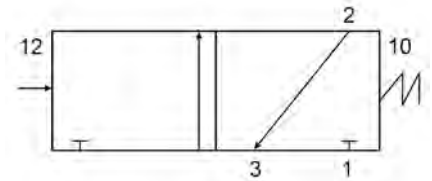

Description	3/2 Pilot Spring Valve
Part No	VAL643
Cross Ref	V61B3D7A-X5090
Main Threads	1/4 BSP
Pilot Thread	M5
Bar	-0.9 to 10
Working Temp	-10 to 50°C Max

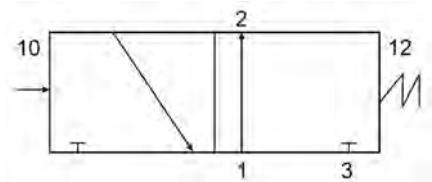

Description	3/2 Pilot/Spring Valve
Part No	VAL691
Cross Ref	S/666/40
Main Threads	1/8 BSP x 3
Pilot Thread	1/8 BSP x 1
Bar	2 to 10
Working Temp	+5 - 80°C Max

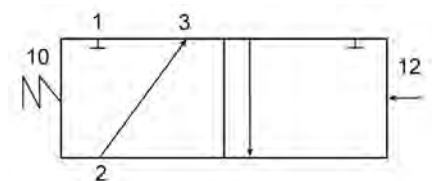

Valves

Description	3/2 Pilot Spring Valve N/C G1/8
Part No	VAL641
Cross Ref	V60A4D7A-XA090
Main Threads	1/8 BSP x 3
Pilot Thread	1/8 BSP x 1
Bar	-0.9 to 10
Working Temp	-10 to 50°C

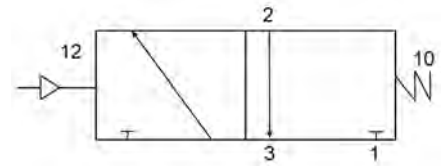

Description	3/2 Pilot - Pilot Valve
Part No	VAL630
Cross Ref	03060702
Main Threads	1/4 BSP x 3
Pilot Thread	1/8 BSP x 1
Bar	2 to 10
Working Temp	+5 to 70°C Max

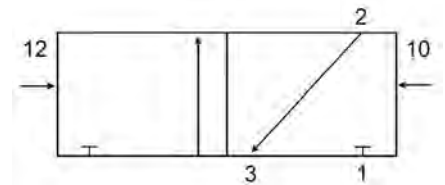

Description	3/2 Button Spring Valve
Part No	VAL672
Cross Ref	S/666/1
Main Threads	1/8 BSP x 3
Pilot Thread	
Bar	2 to 10
Working Temp	+5 to 80°C Max

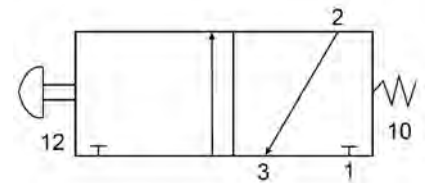

Description	3/2 Emergency Stop Valve
Part No	VAL639
Cross Ref	03042802
Main Threads	1/8 BSP
Bar	0 to 10
Working Temp	0 to 70°C Max

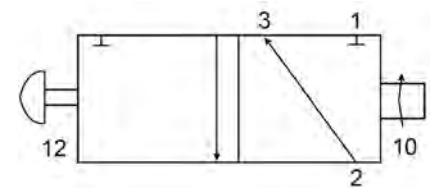

Description	3/2 Emergency Stop Valve
Part No	VAL839
Cross Ref	338-977
Main Threads	1/8"
Bar	-0.9 to 10 bar
Working Temp	0 to 60 degree C Max

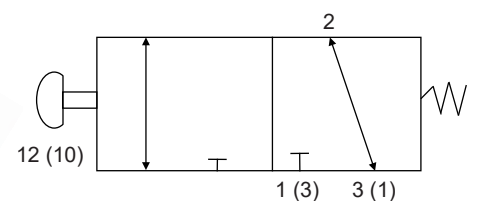

Description	3/2 Button Spring Valve (Red)
Part No	VAL616
Cross Ref	03040602
Main Threads	1/8 BSP x 3
Bar	2 to 10
Working Temp	0 to 70°C Max
Working Temp	0 to 70°C Max

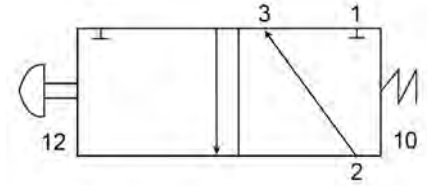

Description	3/2 Button Spring Valve
Part No	VAL816
Cross Ref	338-915
Main Threads	1/8"
Bar	-0.9-10 bar
Working Temp	0 to 60 degree C

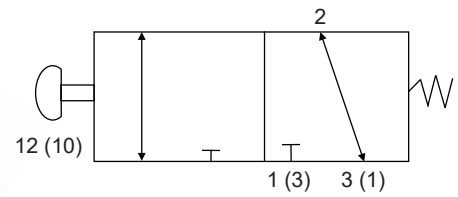

Description	3/2 Button Spring Valve (Green)
Part No	VAL617
Cross Ref	03040502
Main Threads	1/8 BSP x 3
Bar	2 to 10
Working Temp	0 to 70°C Max
Working Temp	0 to 70°C Max

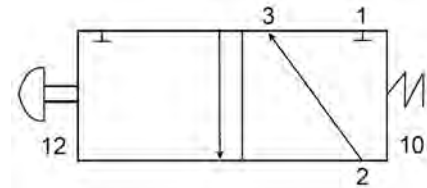

Description	3/2 Black Button Spring Valve
Part No	VAL614
Cross Ref	03040402
Main Threads	1/8 BSP x 3
Bar	2 to 10
Working Temp	0 to 70°C

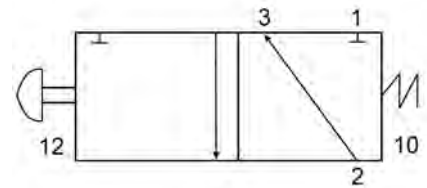

Description	3/2 Button Spring Valve
Part No	VAL680
Cross Ref	03041402
Main Threads	1/8 BSP
Bar	-0.9 to 10
Working Temp	0 to 70°C Max

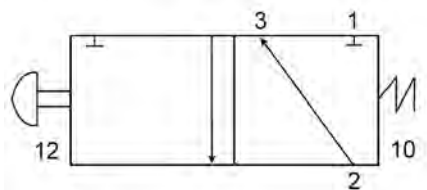

Valves

Description	3/2 Lever Spring Valve
Part No	VAL645
Cross Ref	03043802
Main Threads	1/8 BSP x 3
Bar	-0.9 to 10
Working Temp	0 to 70°C Max

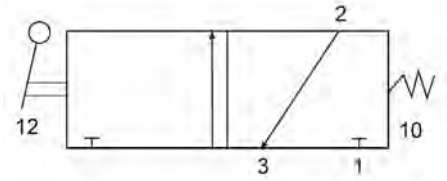

Description	3/2 Lever Spring Valve
Part No	VAL722
Cross Ref	03063802
Main Threads	1/4 BSP x 3
Bar	2 to 10
Working Temp	0 to 70°C Max

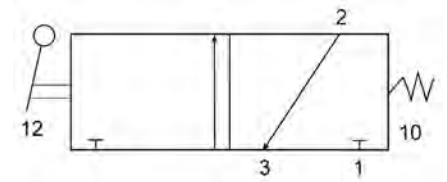

Description	3/2 Lever Spring
Part No	VAL922
Cross Ref	434-905
Main Threads	1/4"
Bar	-0.9-10 bar
Working Temp	0 to 60 degree C

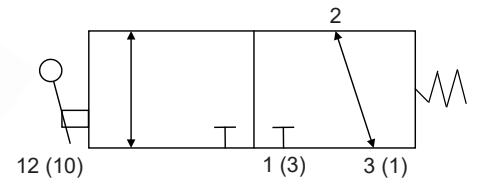

Description	3/2 Push Pull Valve (Visiwink)
Part No	VAL602
Cross Ref	03035103
Main Threads	1/8 BSP x 3
Pilot Thread	1/8 BSP x 1
Bar	2 to 10
Working Temp	-15 to 50°C Max

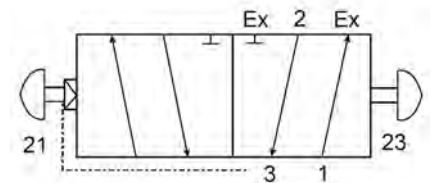

Description	3/2 Push Pull Valve or Pilot Return
Part No	VAL629
Cross Ref	03062702
Main Threads	1/4 BSP x 3
Pilot Thread	1/8 BSP x 1
Bar	2 to 10
Working Temp	0 to 70°C Max

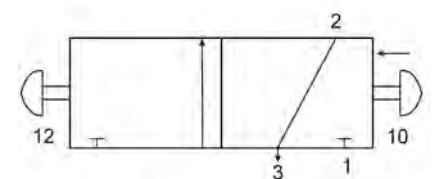

Description	3/2 Push Pull Valve
Part No	VAL632
Cross Ref	03062502
Main Threads	1/4 BSP x 3
Bar	2 to 10 Bar
Working Temp	0 to 70°C Max

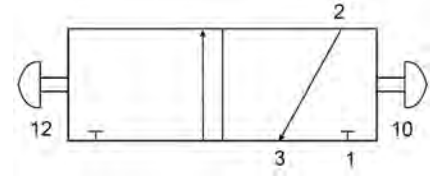

Description	3/2 Push Pull Valve
Part No	VAL626
Cross Ref	03042502
Main Threads	1/8 BSP x 3
Bar	2 to 10 Bar
Working Temp	0 to 70°C Max

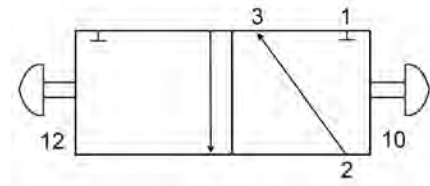

Description	3/2 Push Pull Valve or Pilot Return Valve
Part No	VAL638
Cross Ref	03042402
Main Threads	1/8 BSP
Pilot Thread	1/8 BSP
Bar	2 to 10
Working Temp	+5 to 70°C

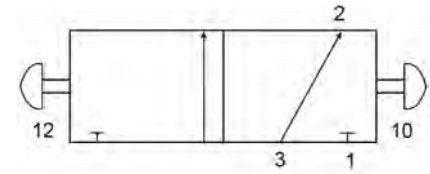

Description	3/2 Roller Lever Valve
Part No	VAL601
Cross Ref	03029302
Main Threads	1/8 BSP x 3
Bar	2 to 10
Working Temp	0 to 70°C Max

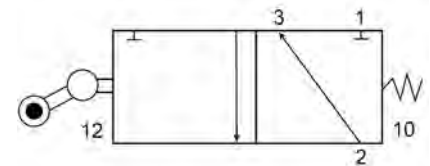

Description	3/2 Roller Trip Valve
Part No	VAL628
Cross Ref	S/666/8
Main Threads	1/8 BSP x 3
Bar	2 to 10
Working Temp	+5 to 80°C Max

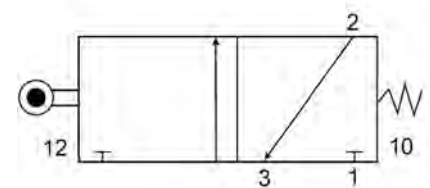

Valves

Description	3/2 Roller Lever Spring Valve
Part No	VAL666
Cross Ref	03061102
Main Threads	1/4 BSP x 3
Bar	2 to 10
Working Temp	0 to 70°C Max

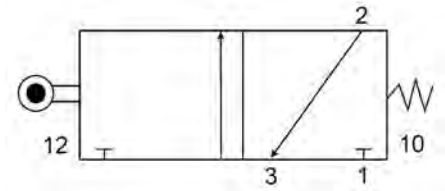

Description	3/2 Roller lever
Part No	VAL866
Cross Ref	134-955
Main Threads	1/4"
Bar	0-10 bar
Working Temp	0 to 60 degree C

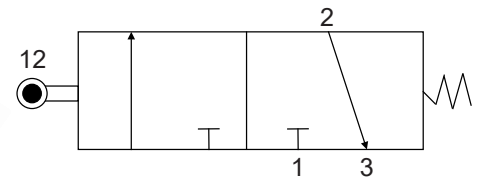

Description	3/2 Roller Lever Spring Valve
Part No	VAL612
Cross Ref	03041102
Main Threads	1/8 BSP x 3
Bar	2 to 10 Bar
Working Temp	0 to 70°C Max

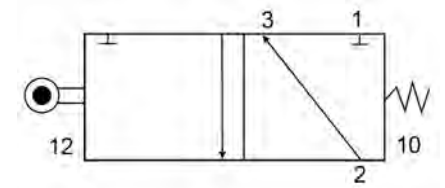

Description	3/2 Roller Lever Valve
Part No	VAL812
Cross Ref	138-955
Main Threads	1/8"
Bar	0-10bar
Working Temp	0 to 60 degree C

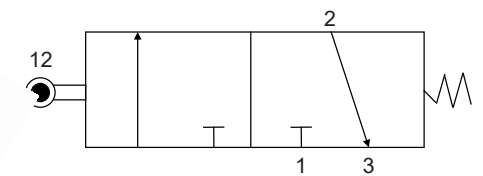

Description	3/2 Roller Lever Spring Valve
Part No	VAL627
Cross Ref	03M29302
Main Threads	G1/8
Bar	2 to 10
Working Temp	0 to 70°C Max

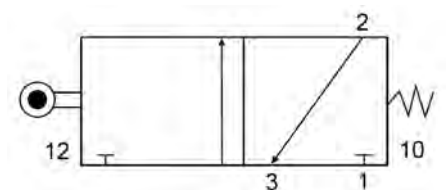

Description	3/2 Roller Spring Valve
Part No	VAL665
Cross Ref	03040202
Main Threads	1/8 BSP x 3
Bar	0 to 10
Working Temp	0 to 70°C

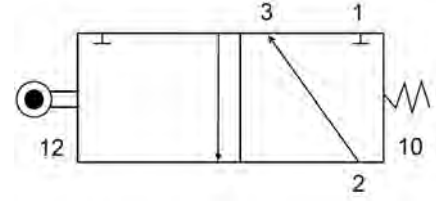

Description	3/2 Roller Lever Valve (Adjustable)
Part No	VAL625
Cross Ref	SPGB/31773
Main Threads	1/8 BSP x 3
Bar	0 - 10
Working Temp	-20 to 80°C Max

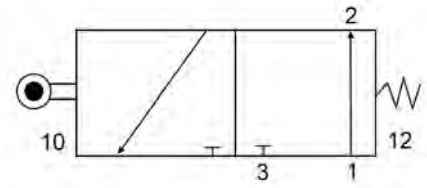

Description	3/2 Valve
Part No	VAL677
Cross Ref	S/666/116
Main Threads	1/8 BSP x 3
Bar	2 to 10
Working Temp	-20 to 80°C Max

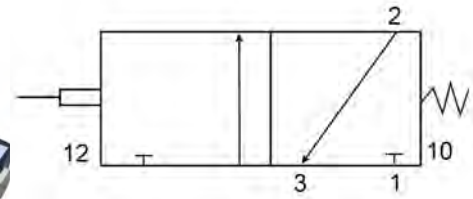

Description	3/2 Foot Button Valve
Part No	VAL637
Cross Ref	SK-03426
Tube OD	4mm
Bar	10 Bar
Working Temp	-20 to 50°C Max

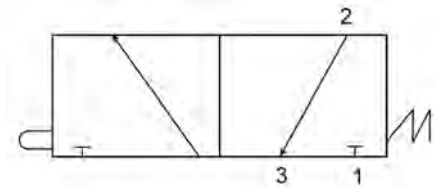

Description	3/2 Solenoid Spring Valve 24v D.C.
Part No	VAL615
Cross Ref	SPGB/28814
Main Threads	M14 x 3
Bar	2 to 10
Working Temp	+5 to 50°C Max

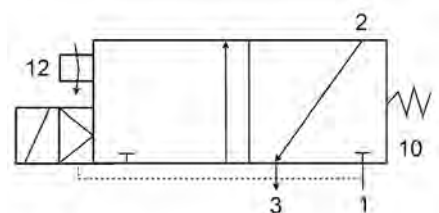

Valves

Description	3/2 Solenoid Spring
Part No	VAL815
Cross Ref	438-015-22
Main Threads	1/8"
Bar	2.5-10 bar
Working Temp	0 to 60 degree C

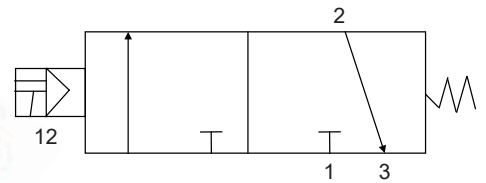

Description	3/2 Solenoid Spring Valve 24v D.C.
Part No	VAL668
Cross Ref	V51B417A-A213J
Main Threads	1/4 BSP x 3
Bar	2 to 8 Bar
Working Temp	+5 to 50°C Max

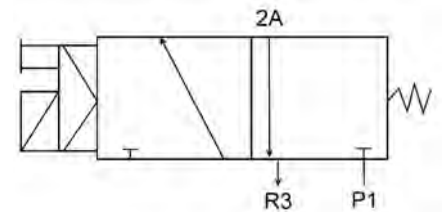

Description	3/2 Solenoid Spring
Part No	VAL868
Cross Ref	434-015-22
Main Threads	1/4"
Bar	2.5-10 bar
Working Temp	0 to 60 degree C

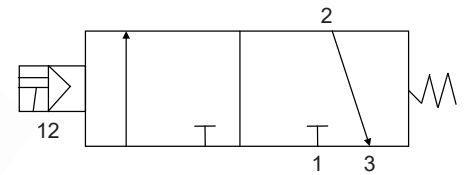

Description	3/2 Solenoid Pilot Valve
Part No	VAL681B
Cross Ref	V61B313A-A213J
Main Threads	G1/4
Exhaust	M5
Bar	2 to 10
Working Temp	-10 to 50°C Max

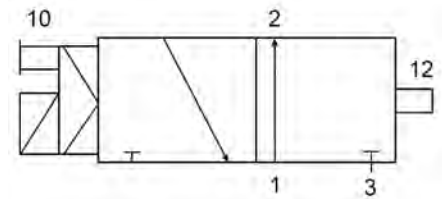

Description	3/2 Solenoid Air Spring Valve
Part No	VAL682
Cross Ref	V60A413A-A2000
Main Threads	G1/8
Bar	2 to 10
Working Temp	-10 to 50°C Max

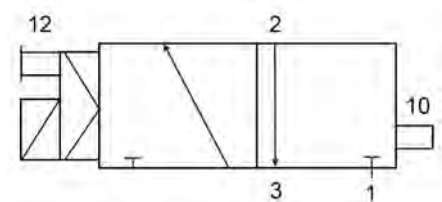

Description	3/2 Solenoid Spring Valve 24v D.C.
Part No	VAL659
Cross Ref	9041005
Main Threads	M12 x 3
Bar	0 to 10
Working Temp	-55 to 100°C

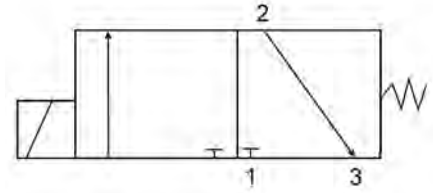

Description	3/2 Solenoid Spring Valve 24v D.C.
Part No	VAL646
Cross Ref	9041025
Main Threads	M12 x 3
Bar	0 to 10
Working Temp	-55 to 100°C Max

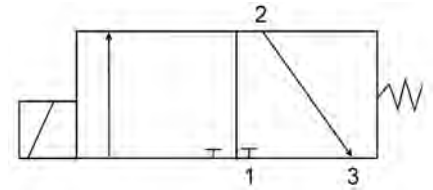

Description	3/2 Solenoid Spring Valve 24v D.C.
Part No	VAL718
Cross Ref	9042026
Main Threads	M12 x 3
Bar	0 to 10
Working Temp	-55 to 10°C

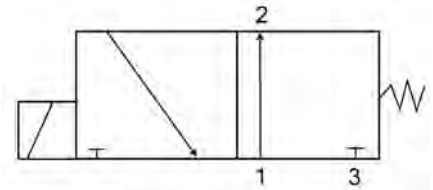

Description	Connector With Lead
Part No	VAL660
Cross Ref	0100446.0000
Length	3m
Type	2 Core
Suits	VAL659



Description	5/2 Pilot Spring Valve
Part No	VAL696
Cross Ref	X3064102
Main Threads	1/4 BSP
Pilot Thread	1/8 BSP
Bar	93 Vac to 10 Bar
Working Temp	70°C Max

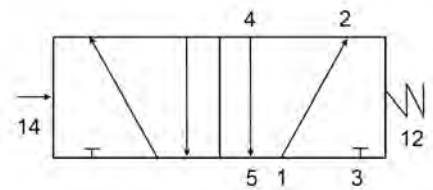

Valves

Description	5/2 Pilot Spring
Part No	VAL896
Cross Ref	354-035
Main Threads	1/4"
Bar	-0.9-10 bar
Working Temp	0 to 60 degree C

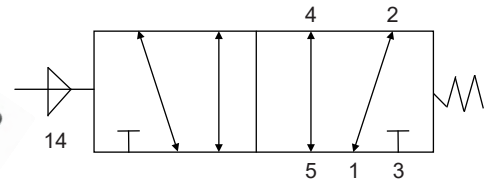

Description	5/2 Pilot Spring Valve
Part No	VAL697
Cross Ref	X3044102
Main Threads	1/8 BSP x 5
Pilot Thread	1/8 BSP x 1
Bar	2 to 10 Bar
Working Temp	0 to 70°C Max

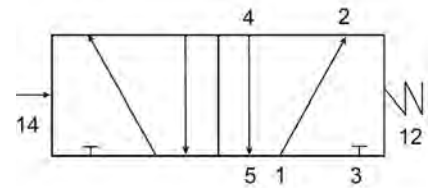

Description	5/2 Pilot Spring Valve
Part No	VAL644A
Cross Ref	V61B5D7A-XA090
Main Threads	G1/4
Pilot Thread	G1/8
Bar	-0.9 to 10
Working Temp	-10 to 50°C Max

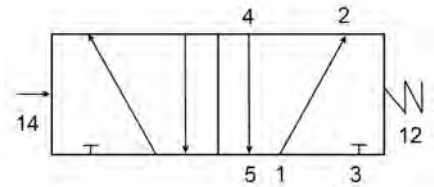

Description	5/2 Push/Pull Valve
Part No	VAL610
Cross Ref	X3046502
Main Threads	1/8 BSP x 5
Bar	2 to 10
Working Temp	0 to 70°C Max

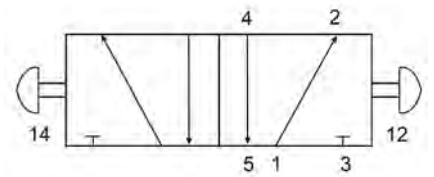

Description	5/2 Push/Pull
Part No	VAL810
Cross Ref	358-910
Main Threads	1/8" x 5
Bar	-0.9 to 10 bar
Working Temp	0 to 60 degree C Max

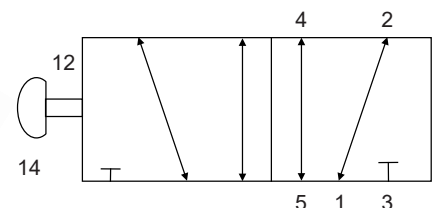

Description	5/2 Push/Pull Valve
Part No	VAL608
Cross Ref	X3066502
Main Threads	1/4 BSP x 5
Bar	2 to 10
Working Temp	0 to 70°C Max

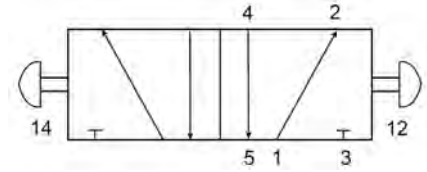

Description	5/2 Push/Pull or Pilot Valve
Part No	VAL678
Cross Ref	X3046402
Main Threads	1/8 BSP x 5
Pilot Thread	1/8 BSP x 1
Bar	2 to 10
Working Temp	0 to 70°C Max

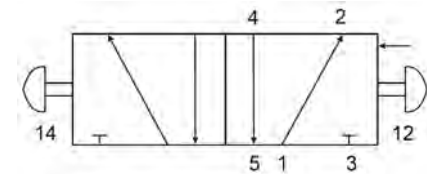

Description	5/2 Push/Pull
Part No	VAL878
Cross Ref	454-910
Main Threads	1/4"
Bar	-0.9 to 10 bar
Working Temp	0 to 60 degree C Max

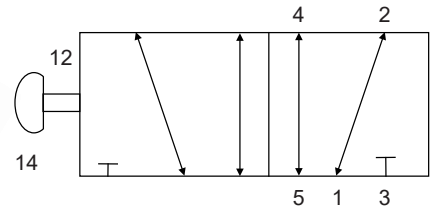

Description	5/2 Emergency Stop Valve
Part No	VAL698
Cross Ref	X3046802
Main Threads	1/8 BSP
Bar	2 to 10
Working Temp	0 to 70°C Max

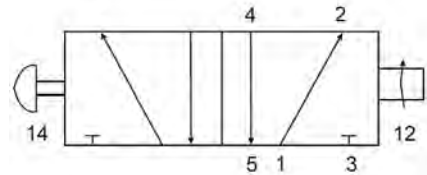

Description	5/2 Emergency Stop
Part No	VAL898
Cross Ref	358-977
Main Threads	1/8"
Bar	-0.9-10 bar
Working Temp	0 to 60 degree C

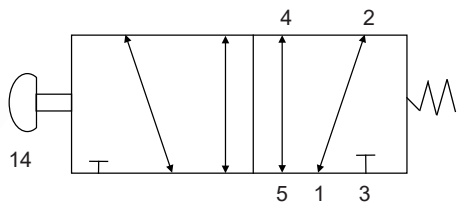

Valves

Description	5/2 Toggle/Toggle Valve
Part No	VAL611
Cross Ref	X3044302
Main Threads	1/8 BSP x 5
Bar	2 to 10
Working Temp	0 to 70°C Max

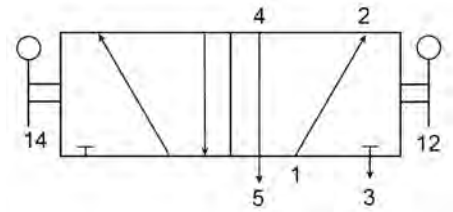

Description	5/2 Toggle/Toggle
Part No	VAL811
Cross Ref	358-990
Main Threads	1/8" x 5
Bar	-0.9 to 10 bar
Working Temp	0 to 60 degree C Max

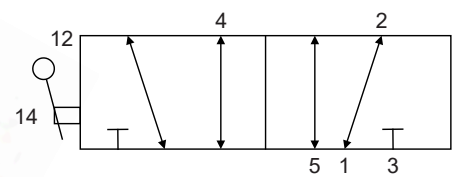

Description	5/2 Lever/Lever Valve
Part No	VAL684
Cross Ref	X3067702
Main Threads	1/4 BSP x 5
Bar	2 to 10
Working Temp	0 to 70°C Max

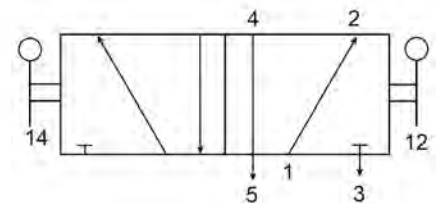

Description	5/2 Lever/Lever
Part No	VAL884
Cross Ref	454-900
Main Threads	1/4" x 5
Bar	-0.9 to 10 bar
Working Temp	0 to 60 degree C Max

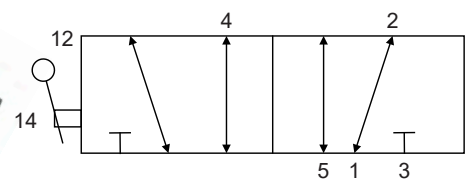

Description	5/3 Lever/Lever/Lever Valve
Part No	VAL673
Cross Ref	X3367702
Main Threads	1/4 BSP x 5
Bar	2 to 10
Working Temp	0 to 70°C Max

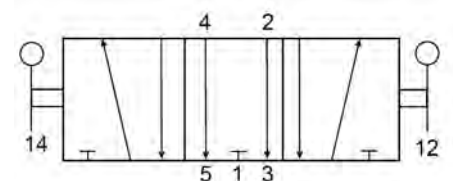

Description	5/3 Lever/Spring/Lever Valve
Part No	VAL674
Cross Ref	X3367802
Main Threads	G1/4
Bar	-0.9 to 10
Working Temp	0 to 70°C Max

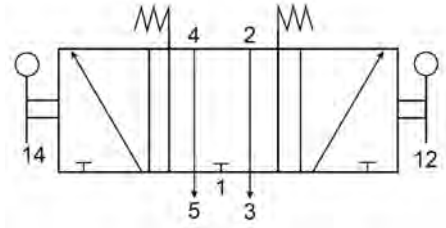

Description	5/3 Lever Spring Lever
Part No	VAL874
Cross Ref	474-900
Main Threads	1/4"
Bar	-0.9-10 bar
Working Temp	0 to 60 degree C

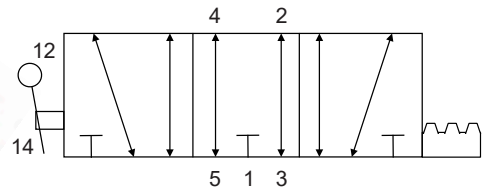

Description	5/2 Solenoid Spring Valve
Part No	VAL609
Cross Ref	V61B517A-A2000
Main Threads	1/4 BSP
Bar	3 -10 Bar
Working Temp	-10 to 50°C Max

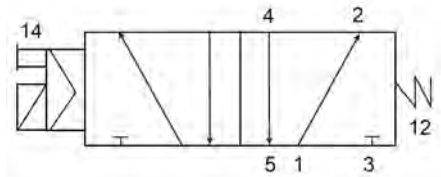

Description	Rota Visi Wink Valve
Part No	VAL619
Cross Ref	5VS-421-800
Main Threads	1/8 BSP
Colours	Off Green / On Red
Bar	0.7 to 8

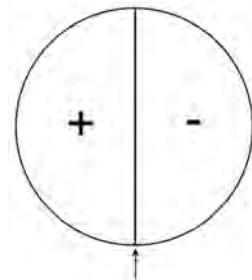

Description	Rota Visi Wink Valve
Part No	VAL618
Cross Ref	5VS-412-800
Main Threads	1/8 BSP
Colours	Off Red / On Green
Bar	0.7 to 8

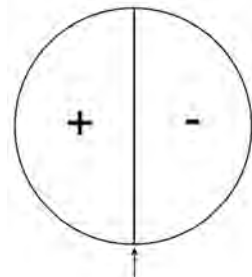

Valves

Description	Rota Visi Wink Valve
Part No	VAL613
Cross Ref	5VS-401-800
Main Threads	1/8 BSP
Colours	Off Black / On Red
Bar	0.7 to 8

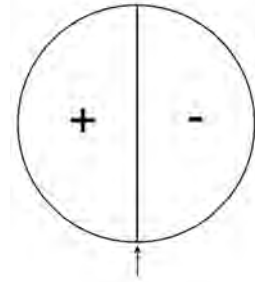

Description	Rota Visi Wink Valve
Part No	VAL633
Cross Ref	5VS-402-800
Main Threads	1/8 BSP
Colours	Off Black / On Green
Bar	0.7 to 8

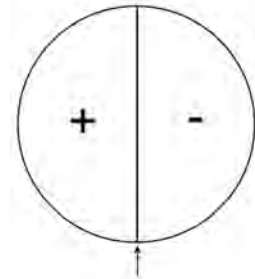

Description	Pressure Regulator (Relieving)
Part No	VAL623
Cross Ref	R73G-2GK-RMN
Main Threads	1/4 BSP x 2
Gauge Thread	1/8 BSP x 2
Bar	0 to 20 inlet/0.3 to 10 outlet
Working Temp	-20 to 80°C Max

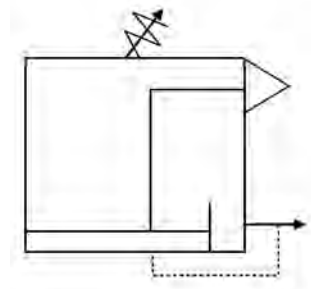

Description	Pressure Regulator (Relieving)
Part No	VAL823
Cross Ref	M004-R000
Main Threads	1/4"
Bar	0 to 16 inlet/0.5-10 outlet
Working Temp	50 degree Max

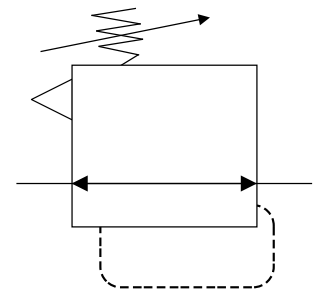

Description	Pressure Regulator (Relieving)
Part No	VAL690
Cross Ref	R72G-2GK-RMN
Main Threads	1/4 BSP x 2
Gauge Thread	1/8 BSP x 2
Bar	0 to 20 inlet / 0.3 to 10 outlet
Working Temp	-20 to 80°C Max

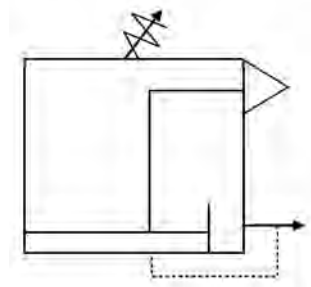

Description	Pressure Regulator (Relieving)
Part No	VAL657
Cross Ref	R07G-200-RNKG
Main Threads	1/4 BSP x 2
Gauge Thread	1/8 BSP x 2
Bar	0 to 20 inlet / 0.3 to 7 outlet
Working Temp	-34 to 65°C Max

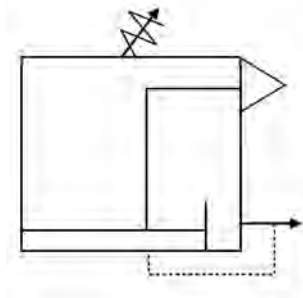

Description	Pressure Regulator (Relieving)
Part No	VAL857
Cross Ref	T104-R70
Main Threads	1/4"
Bar	0 to 12 inlet/0.5-10 outlet
Working Temp	50 degree Max

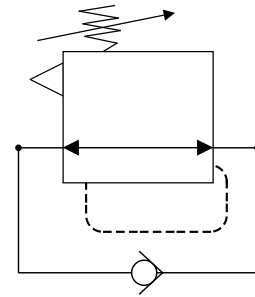

Description	Pressure Regulator (Relieving)
Part No	VAL624
Cross Ref	R73G-4GK-RMN
Main Threads	1/2 BSP x 2
Gauge Thread	1/8 BSP x 2
Bar	0 to 20 inlet / 0.3 to 7 outlet
Working Temp	-20 to 80°C Max

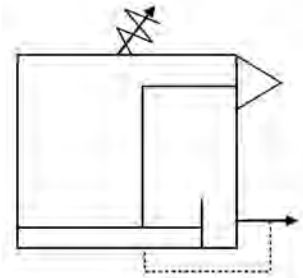

Description	Non-Return Valve
Part No	VAL648
Cross Ref	T50P0008
Tube OD	8mm
Bar	16 Max
Working Temp	80°C Max

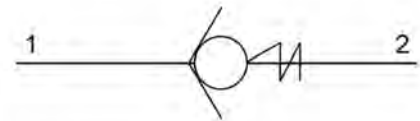

Description	Non-Return Valve
Part No	VAL656
Cross Ref	T50P0010
Tube OD	10mm
Bar	16 Max
Working Temp	80°C Max

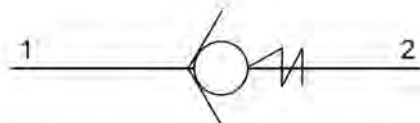

Valves

Description	Non-Return Valve
Part No	VAL654
Cross Ref	T50P0012
Tube OD	12mm
Bar	16 Max
Working Temp	80°C Max

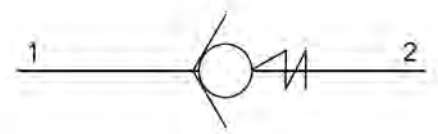

Description	Non-Return Valve
Part No	VAL700
Cross Ref	97482901BP
Threads	M22 x 1.5 (M/F)

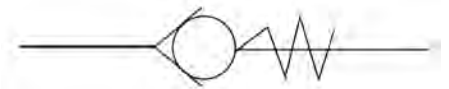

Description	Pilot Blocking Valve
Part No	VAL620
Cross Ref	102GA0628
Main Thread	1/4 BSP
Pilot Thread	M5
Tube OD	6mm
Bar	+1 to 10
Working Temp	-20 to +80°C

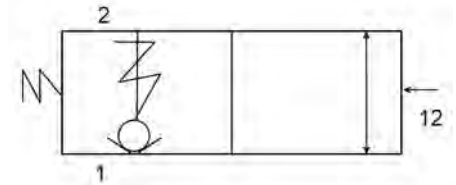

Description	In-line Flow Regulator
Part No	VAL731
Cross Ref	C00GE0600
Tube OD	6mm
Working Temp	0 to 60°C Max

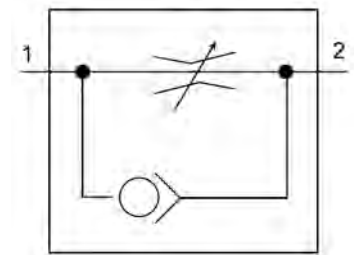

Description	In-line Flow Regulator
Part No	VAL733
Cross Ref	C00GE1000
Tube OD	10mm
Working Temp	0 to 60°C Max

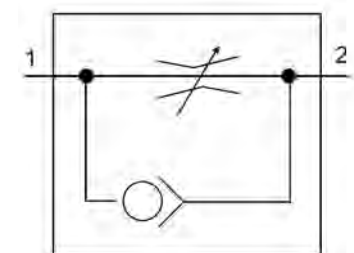

Description	Coil Assembly
Part No	VAL685
Cross Ref	QM/48/13J/21
Type	24V/DC,0.08A
	2.0W



Description	Plug 22mm Industrial Standard with Gland
Part No	VAL687
Cross Ref	M/P19063
Plug	22mm
Voltage AC	12-250V
Voltage DC	12-250V



Description	Operating Head
Part No	VAL719
Cross Ref	V12460-C02



Description	Trailer Park Valve
Part No	VAL679
Cross Ref	10223312
Main Threads	M16 x 3
Exhaust Fitting	1/4 BSP
Bar	10 Max
Working Temp	-25 to 60°C Max
Button Part No	VAL679BUT



Description	Exhaust Filter
Part No	VAL622
Cross Ref	M/1512 / 2901 1/4-17
Main Threads	1/4"
Bar	0-10 bar
Working Temp	-20 to +30 degree C

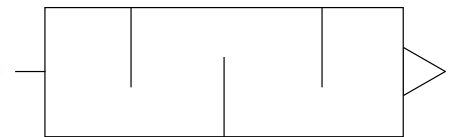

Description	Brass Porous Silencer
Part No	VAL675
Cross Ref	MS002A
Thread	1/4" NPT
Working Temp	2 to 80°C Max

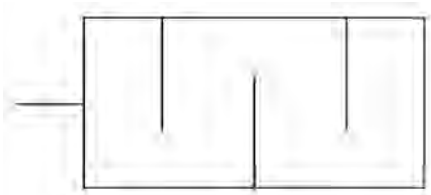

Valves

Description	Pressure Gauge
Part No	VAL712
Cross Ref	18-013-013
Type	50mm Dia / Rear Entry
Thread	1/8 BSPT
PSI	0 to 140
Bar	0 to 10



Pressure Gauge	Description
Z0119	Part No
18-013-989	Cross Ref
40mm Dia / Rear Entry	Type
1/8 BSPT	Thread
0 to 140	PSI
0 to 10	Bar

Description	Pressure Gauge
Part No	VAL872
Cross Ref	M043 P12
Type	43mm Dia Rear Entry
Thread	1/8"
Psi	0 to 174
Bar	0 to 12

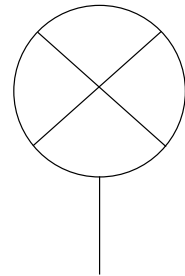

Description	Exhaust Guard
Part No	VAL702
Cross Ref	0613423
Threads	1/2 BSP / 1/2 NPT



Description	Porous Plastic Silencer
Part No	VAL671
Cross Ref	M/S3 / 2928 3/8
Thread	3/8 BSPP
Working Temp	0 to 50°C Max

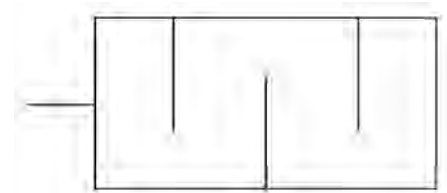

Description	Porous Plastic Silencer
Part No	VAL621
Cross Ref	C/S4
Thread	1/2 NPT
Working Temp	0 to 50°C Max

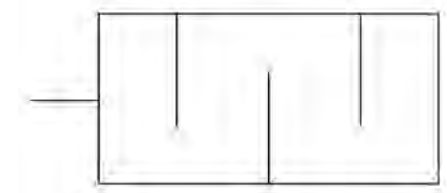

Description	Filter Regulator
Part No	VAL634
Cross Ref	BL72-201G
Main Threads	1/4 BSP
Gauge Thread	1/8 BSP
Bar	0.3 to 10
Working Temp	-20 to 50°C

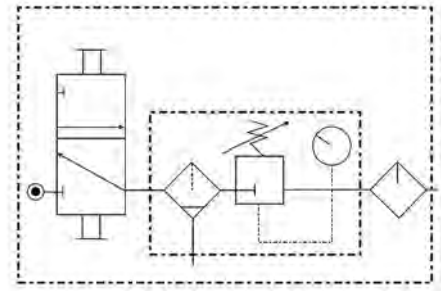

Description	Filter Regulator
Part No	VAL704
Cross Ref	B72G-2GK-AL3-RMN
Main Threads	1/4 BSP
Gauge Thread	1/8 BSP
Bar	0.3 to 10
Working Temp	-34 to 50°C

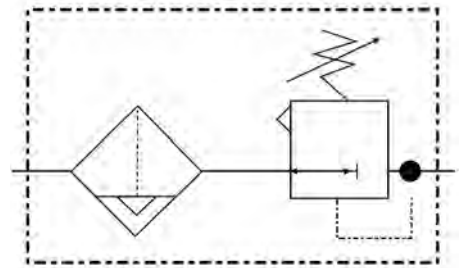

Description	Coil Assembly
Part No	VAL652
Cross Ref	QM/48/83J/28
Type	24V DC, 0.25A, 6.0W, 83J, IP65, 100%ED 2413



Description	Bracket
Part No	VAL657B
Cross Ref	18-025-003



Description	Emergency Valve Kit
Part No	VAL800
Contents	
Plugs	1/4 x 3
Silencers	1/4 - 17 x 2
DIN Connector	x 1
Solenoid Connectors	x 2
5/2 Valve	x 1
Enlarger Junction	6-4 x 1
Swivel Elbow	4-M5 x 1
Male Studs	x 6



Don't let unexpected breakdowns interrupt your productivity.

Our emergency valve kit is specifically designed for quick and reliable repairs

Each kit includes precision engineered components that meet the highest standards of quality and durability

Our comprehensive selection ensures you have the right fix at the right time, minimising downtime and keeping your vehicle operational and running smoothly

Page 10.2 - 10.4

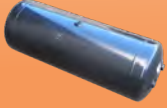
Air Reservoirs

These air reservoirs are CE-Marked and approved to EN286-2, the dimensions are in accordance with DIN 74281, operating pressures to 12.5 bar, finished in EPC black powder coated, all threads being M22 x 1.5 ISO/DIN standard.

Page 10.8

Side Guards

Suitable for trucks and trailers. For under-body mounting. Variable lift and pin options. Zinc plated to BS EN123-2000. Fixing kit supplied. Head supplied with removable security lock pin with 'R' clip and pvc rope

Page 10.8 - 10.9

Rubber Bump Stops

We have a wide range of heavy duty fabricated rubber buffers and rollers made from EPDM

Page 10.10

Brake Chamber Spares

We have a range of brake chamber spares from yokes and clevis pins to a full range of diaphragm for both standard and long stroke chambers

Page 10.5 - 10.12

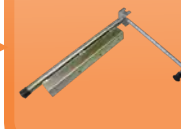
Chassis Equipment

A range of cable retainers, spring loaded door retainers manufactured in the UK by our sister company Vernon developments

Page 10.7

Coupling Boxes

Coupling Boxes manufactured in 2mm thick steel, features 24n-24s and ISO 7638 ABS-EBS cut-outs, hinged front panel plate with check chain, fitted to a range of trailers as original equipment

Page 10.9

Wheel Nuts

We supply both metric and imperial wheel nuts, both left and right hand available

Page 10.11-10.12

Hand Brake Spares

Our handbrakes come with PVC sleeve handles with a one-piece fabricated base plate, finished to BZP to BS EN 12329:2000, we also have compensators, Galvanised cable and cable grips to suit.

Air Reservoirs - End Mounted

- These end mounted reservoirs are CE-Marked and approved to EN286-2
- Temperature range -40°C/+100°C.
- Dimensions are in accordance with DIN 74 281.
- Operating pressure is 12.5 Bar.
- Finished in EPC black powder coated
- All threads being M22 x 1.5 ISO/DIN standard.
- Also non-standard versions are available upon request.

Steel End Mounted 5 Port Reservoirs

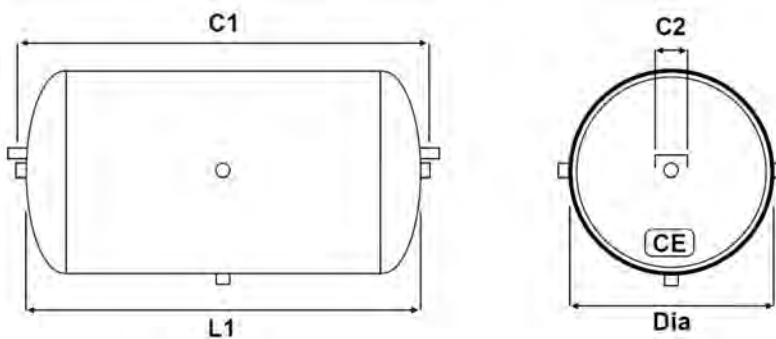

Part No	9956
Litres	50
C1 - mm	800
C2 - mm	57
Dia - mm	310
L1 - mm	734
Ports	M22 x 1.5
Mass Kgs	16.5

Steel End Mounted 6 Port Reservoirs

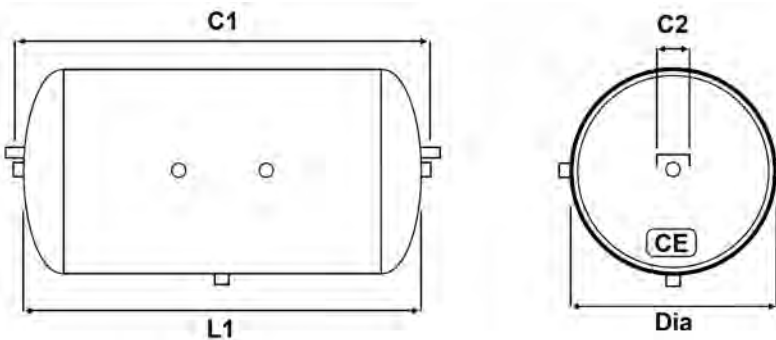

Part No	9962
Litres	60
C1 - mm	956
C2 - mm	57
Dia - mm	310
L1 - mm	890
Ports	M22 x 1.5
Mass Kgs	17

Strap Mounted 6 Port Reservoirs

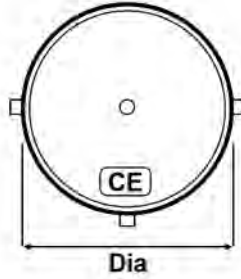
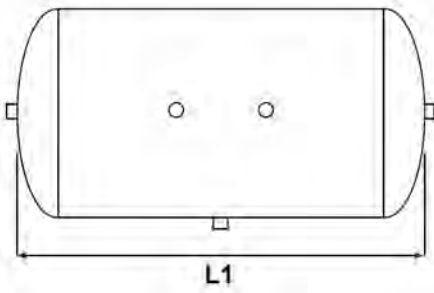

Part No	9963
Litres	60
Dia - mm	310
L1 - mm	873
Ports	M22 x 1.5
Mass Kgs	16.2

Strap Mounted 5 Port Reservoirs

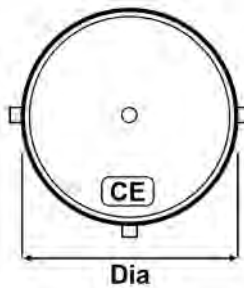
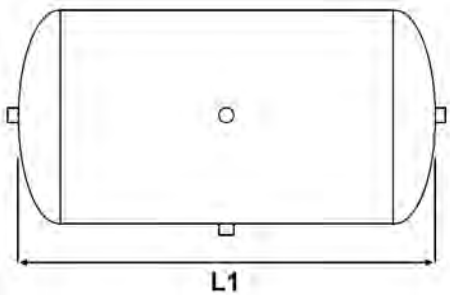

Part No	9958
Litres	40
Dia - mm	310
L1 - mm	588
Ports	M22 x 1.5
Mass Kgs	12.7

Mounting Straps (Sold in Pairs)



Part No	9975	9976	9977	9978
Dia - mm	206	246	310	396

Air Reservoirs - Side Mounted

Steel Side Mounted 4 Port Reservoirs

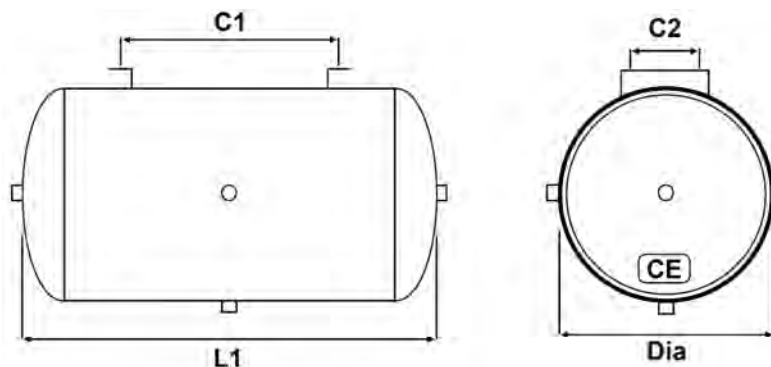

Part No	9940	9946
Litres	10	20
C1 - mm	200	380
C2 - mm	120	120
Dia - mm	206	206
L1 - mm	340	657
Ports	M22 x 1.5	M22 x 1.5
Mass Kgs	5.7	9.2

Steel Side Mounted 4 Port Reservoirs

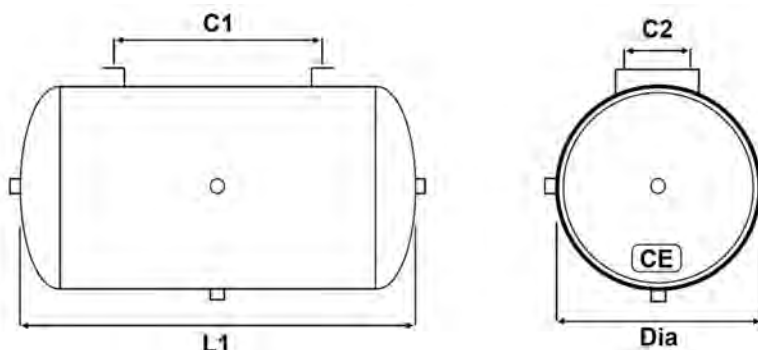

Part No	Z9961CART
Litres	60
C1 - mm	600
C2 - mm	120
Dia - mm	310
L1 - mm	873
Ports	M22 x 1.5
Mass Kgs	16

Steel Side Mounted 4 Port Reservoirs

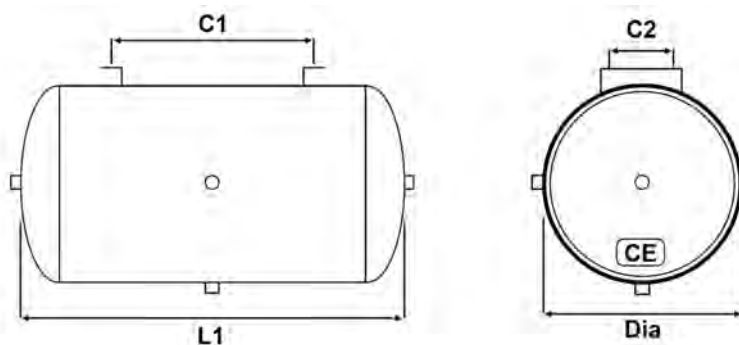

Part No	9964
Litres	60
C1 - mm	382
C2 - mm	120
Dia - mm	310
L1 - mm	873
Ports	M22 x 1.5
Mass Kgs	18.4

Steel Side Mounted 6 Port Reservoirs

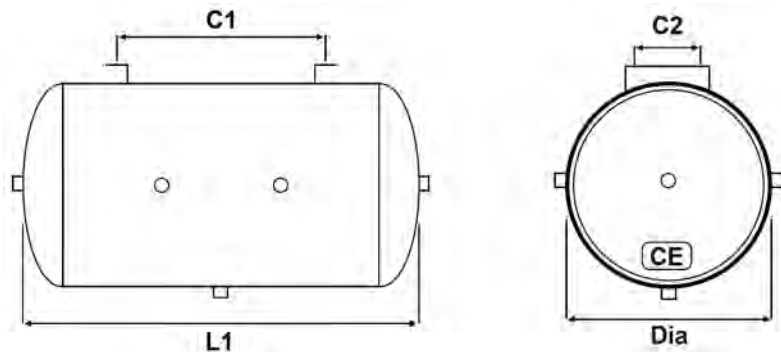

Part No	9961
Litres	60
C1 - mm	380
C2 - mm	120
Dia - mm	310
L1 - mm	873
Ports	M22 x 1.5
Mass Kgs	18.8

Spring Hooks & Chain

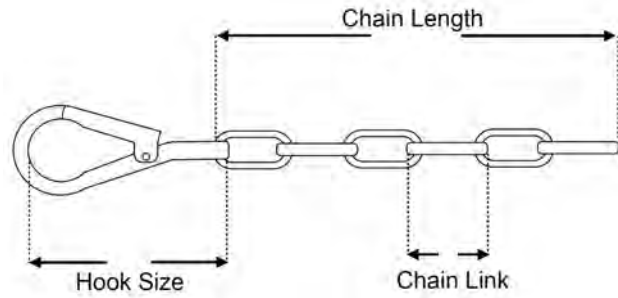

A series of Heavy Duty sprung latched steel Hooks finished plated in Bright Zinc, clear Passivate. Hooks can be supplied individually, with varying lengths of chain or complete with a selection of end fittings. Chain construction is 3 x 21mm Zinc Plated with a Mass 0.165kgs/mtr. Hook and Chain Assembly can be supplied with supplementary end fitting. Please call for more information.

Hook Size	Chain Links	Chain Length	Link Length	Kgs	Part No.
75mm	9	180mm	21mm	0.044	V71129
102mm	14	285mm	21mm	0.126	V71132

Bolt-on Stay Fast Latch

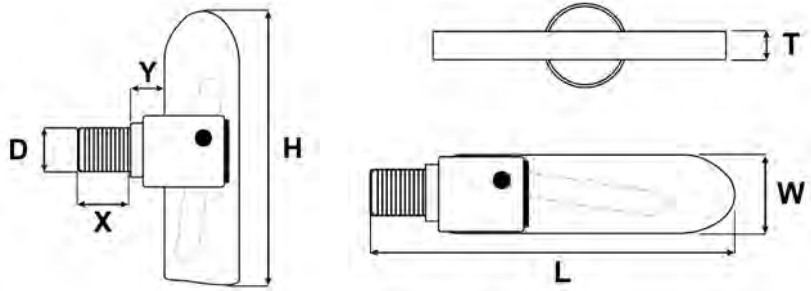

L	W	H	T	D	X	Y	Mass Kgs	Part No.
104mm	19.5mm	72mm	6	M12 x 1.75	25	6.8	0.09	V73025A
114mm	19.5mm	72mm	6	M12 x 1.75	34	6.8	0.1	V73034A
95mm	12.5mm	50mm	4	M8 x 1.25	38	6.8	0.04	V73038
155mm	19.5mm	72mm	6	M12 x 1.75	76	6.8	0.12	V73076A

Manufactured in High Grade Machine Steel, Supplied in various sizes, 'A' Suffix represents complete with Nut & Washer

Chassis Components

Cable Retainer Clear

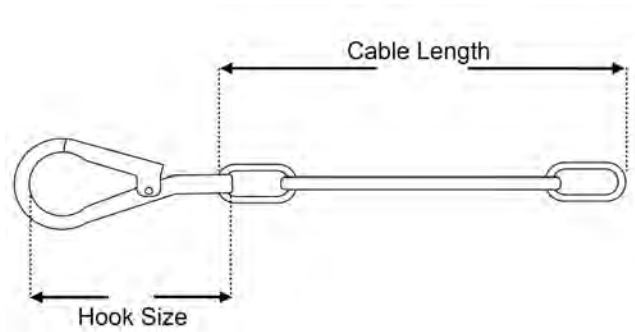

Cable Length	Over All Length	Hook	cable	Mass Kgs	Part No.
400mm	470mm	75mm	3mm Galvanized	0.100kg	V71634

Spring Loaded Door Retainer

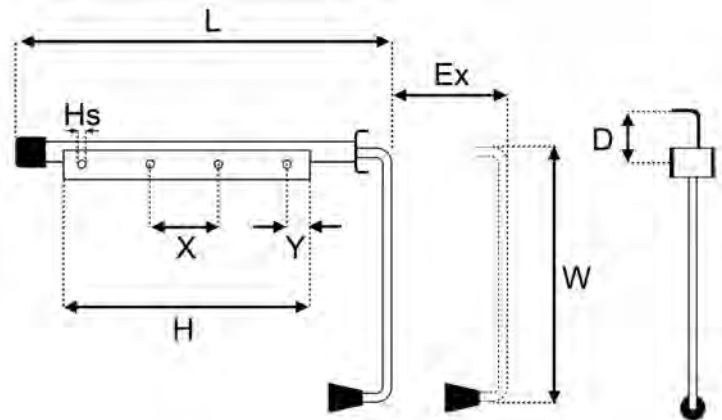

L	W	H	Ex	D	Hs	X	Y	Mass Kgs	Part No.
510	340	350	200	40	9	100	25	2.5	V235006

Manufactured in ERW steel tube retainers, Supplied with rubber door buffer

Slim-Line 3 Line Coupling Box

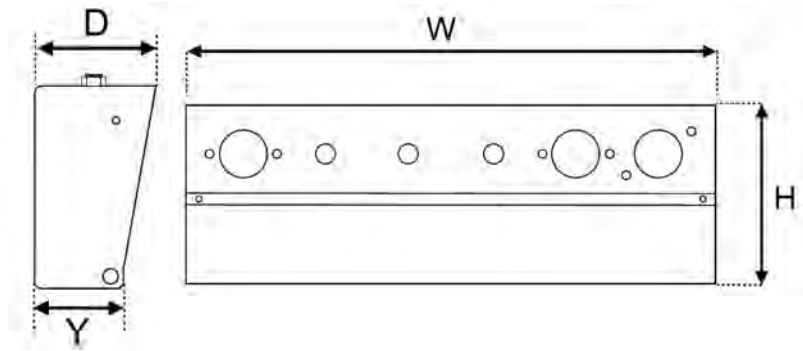

W	H	D	Y	Mass Kgs	Part No.
604	200	120	85	5.5	V231019

Manufactured in 2mm thick steel, Features 24n-24s and ISO 7638 ABS-EBS cut-outs, Hinged front panel plate with check chain

High-Line 2 Line Coupling Box

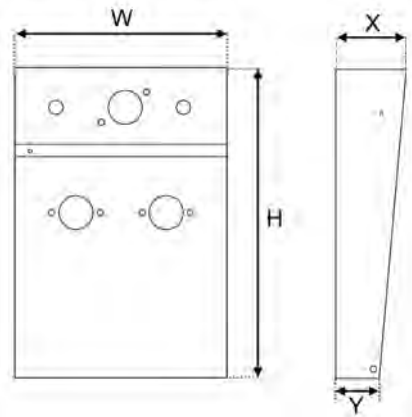

W	H	X	Y	Mass Kgs	Part No.
305	450	120	80	6.2	V231046

Manufactured in 2mm thick steel, Features 24n-24s and ISO 7638 ABS-EBS cut-outs, Hinged front panel plate with check chain

Chassis Components

Hinge-up Side Guard Leg

Suitable for trucks and trailers. For under-body mounting. Variable lift and pin options.
Zinc plated to BS EN123-2000. Fixing kit supplied.
Head supplied with removable security lock pin with 'R' clip and pvc rope. Front mounting channel for lateral rails is pre-punched with 10mm slotted holes

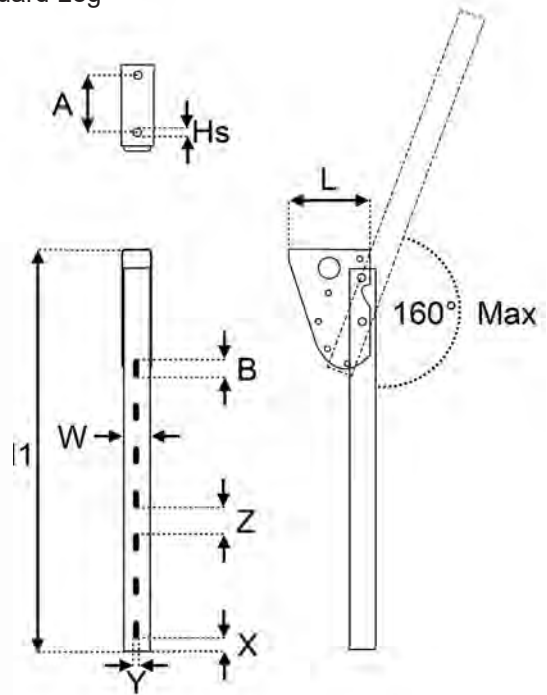

L	W	H1	Hs	A	B	X	Y	Z	Mass Kgs	Part No.
150	50	740	12.5	110	30	23	10	50	3.5	V233067

Head Thickness 2.25mm / Leg Thickness 2mm

Twin Roller Buffer

Heavy duty fabricated steel
Body 25mm axle shaft
Rubber rollers made from EPDM Unique Toe Grip Pattern

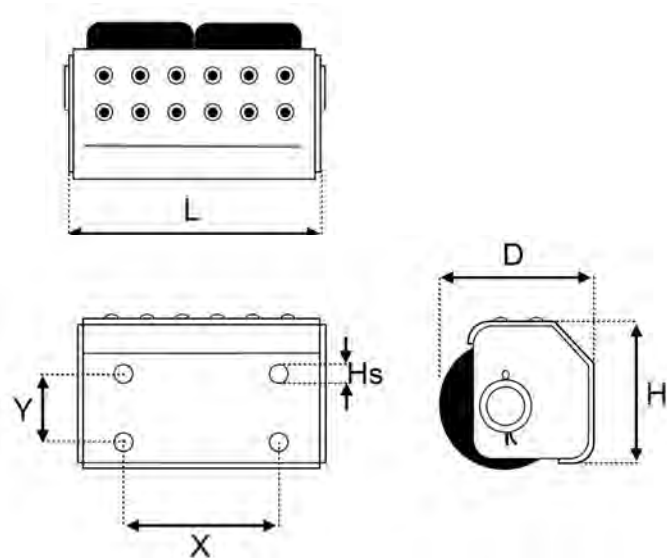

L	H	D	Hs	X	Y	Mass Kgs	Part No.
190	120	120	13	120	52	6.25	V240010

Old Style 28mm replacement roller Part No. V240012

Solid Rubber Buffer - 2 Bolt

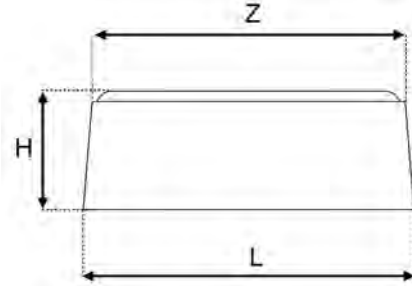
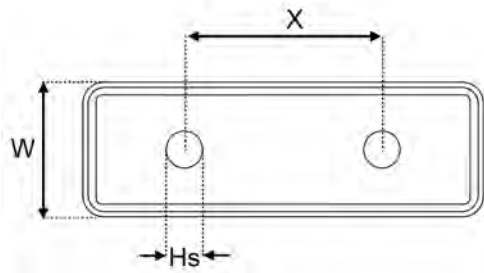

Type	L	W	H	Hs	X	Z	Part Number
A	345	100	108	12	200	325	V240001
B	240	80	90	12	120	230	V240002
C	195	80	80	12	90	180	V240003
D	210	50	58	10	125	178	V240005

Manufactured in EPDM, Supplied with thru holes for chassis mounting

Wheel Nut - Right Hand



Size	Part No.
7/8 BSF	V61098

Wheel Nut - Left Hand



Size	Part No.
7/8 BSF	V61099

Wheel Nut - 26mm Deep



Size	Part No.
M22 x 1.5	V61143

Chassis Components

Standard Air Brake Diaphragms



Type	Part No.
12	9100
16	9101
20	9102
24	9103
30	9104

Long Stroke Air Brake Diaphragms



Type	Part No.
20	9107
24	9108

Clevis Yoke & Pin Assemblies



Pin	Thread	Type	Part No.
1/2	M16 x 1.5	Standard	V31107
14mm	M16 x 1.5	Standard	V31109
14mm	M16 x 1.5	Long	V31276
16mm	M16 x 1.5	Standard	V31329

Clevis Pin



Length	Width	Kgs	Part No.	Pack
42.5	1/2	0.05	V31008	10
40	10mm	0.03	V31367	1
42.5	14mm	0.06	V31113	10
42.5	16mm	0.07	V31306	1

Winding Handles

Winding handles manufactured in solid round bar and supplied with a 'T' slotted end.
 All handles finished in zinc and yellow passivate to BS1706 and supplied with a rotating double width steel hand grip finished in EPD black
 Hexagon adaptors can be used to convert from round drive shafts for use with hexagon handles

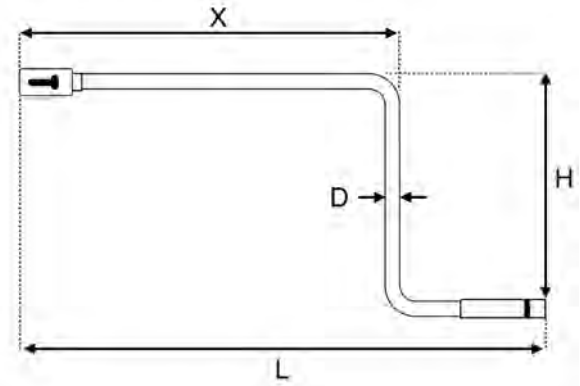

Type	End Type	L	H	D	X	Mass Kgs	Part No.
BDMS Bar	Slotted	840	350	22	560	4	V81028

7 x 7 Element Galvanised Preformed Steel Rope Manufactured to BS3530



Cable Dia	Breaking Load	Cable Length	Shipping State	Mass Kgs	Part No.
1.5mm	0.15	50 mtrs	Coil	0.62	V51157
3mm	0.58	30 mtrs	Coil	1.1	V51319

Cable Grip (Sold in Packs of 20)



Sizes	Type	Pkt No.
6mm	Galvanised	V51001

Chassis Components

Trailer Hand Brake

- One-piece fabricated base plate
- Right-handed version
- Minimum maintenance required
- PVC sleeve fitted as standard
- Finish: BZP to BS EN 12329:2000
- Finish: Powder coating to BS4950

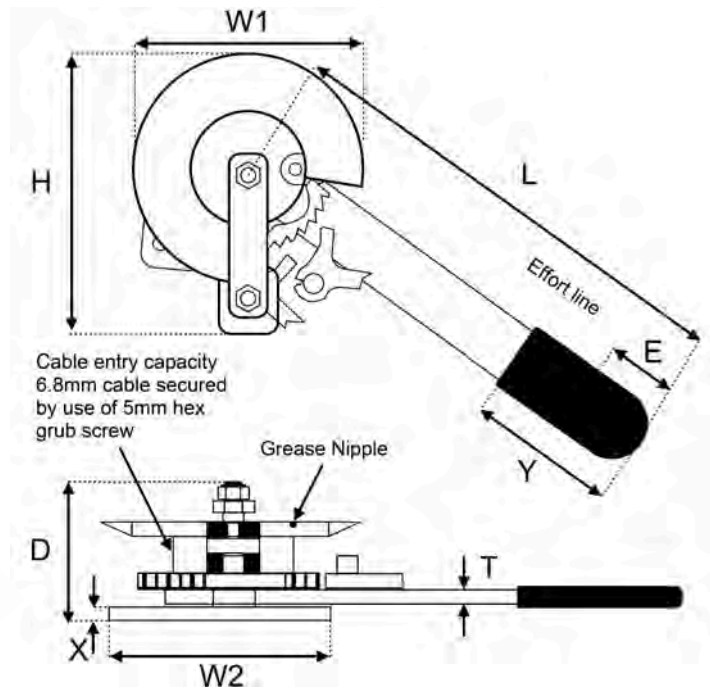

L	W1	W2	H	T	D	E	X	Y	Mass Kgs	Part No.
550	57	150	185	8	80	40	10	155	4.6	V234001

Handbrake Compensator

- A selection of steel fabricated compensators designed specifically for use with vehicles fitted with mechanical type handbrakes, All compensators are supplied complete and finished in zinc and yellow passivation to BS1706
- Some replacement parts are available



Size	Mass Kgs	Part No.
390 - 420mm	2.18	V234395

Maxi-stor Assorted Boxes

Tube Gears quality Maxi-stor storage systems are user friendly, compact, sturdy, lightweight and have removable compartments, designed to keep your components neatly sorted and easily accessible.

Complete with transparent tightly fitting lid, with handle, 2 sliding catches and shatter proof hinges.

Resistant to weather and chemicals.

Size: Height 57mm x Width 338mm x Depth 261mm.



Megabox Assorted Boxes

Tube Gears mega-boxes are user friendly, compact, with a spacious design, featuring removable inserts and a transparent lid for easy access and identification of components.

With weather and chemical resistance, along with shatter-proof hinges, these boxes are built to withstand the toughest working environments, making them essential tools for any workshop or repair vehicle.

Size: Height 85mm x Width 480mm x Depth 375mm.



Standard Assorted Boxes

Tube Gear's standard assorted boxes, are durable and built to withstand the rigors of your workshop, these boxes are constructed from high-quality plastic that resists corrosion and most chemicals.

With a transparent lid that ensures visibility of contents, while the sturdy catches provide secure transportation between locations. these boxes are the ideal choice to keep your air brake fittings organised and readily accessible in any setting.

Size: Height 42mm x Width 138mm x Depth 219mm.

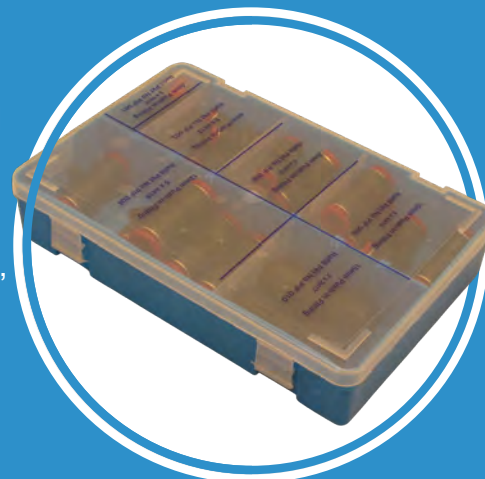

Note: Contents are subject for change

Maxi-Stor Assorted Box Content

Plastic Push In - MSK240		
Part No.	Description	Qty
2417	straight connector 15x1.5mm - 15x1.5mm	4
4410	straight connector 4x1mm - 4x1mm	10
4411	straight connector 5mm	10
4412	straight connector 6x1mm - 6x1mm	10
4413	straight connector 8x1mm - 8x1mm	10
4415	straight connector 10mm - 10mm	10
4416	straight connector 12x1.5mm - 12x1.5mm	10
4423	straight connector 1/4 - 1/4	5
4425	straight connector 3/8 - 3/8	3
4426	straight connector 1/2 - 1/2	5
4453	tee connector 6x1mm - 6x1mm - 6x1mm	10
4454	tee connector 8x1mm - 8x1mm - 8x1mm	5
4455	tee connector 10mm - 10mm - 10mm	5

Brass Compression Metric - MSK330		
Part No.	Description	Qty
5301	straight connector 11mm	6
5309	straight connector 9mm	10
5311	straight connector 4mm	5
5322	straight connector 6mm	5
5333	straight connector 8mm	10
5344	straight connector 10mm	8
5355	straight connector 12mm	6
5366	straight connector 13mm	3
5377	straight connector 14mm	3
5388	straight connector 15mm	3
5399	straight connector 16mm	2
5522	tee connector 6x1mm - 6x1mm - 6x1mm	4
5533	tee connector 8x1mm - 8x1mm - 8x1mm	4
5544	tee connector 10x1.25mm	2
5555	tee connector 12x1.5mm - 12x1.5mm - 12x1.5mm	2
5942	straight stud 1/4bsp - 6mm	8
5944	straight stud 1/4bsp - 10mm	8

Brass Olives - MSK300		
Part No.	Description	Qty
5001	stepped olive 1/8	50
5002	stepped olive 5/32	50
5003	stepped olive 3/16	50
5004	stepped olive 1/4	50
5005	stepped olive 5/16	50
5006	stepped olive 3/8	50
5007	stepped olive 1/2	25
5008	stepped olive 5/8	10
5011	barrel olive 1/8	50
5012	barrel olive 5/32	50
5013	barrel olive 3/16	50
5014	barrel olive 1/4	50
5015	barrel olive 5/16	50
5016	barrel olive 3/8	50
5017	barrel olive 1/2	25
5018	barrel olive 5/8	10
5021	stepped olive 4mm	50
5022	stepped olive 6mm	50
5023	stepped olive 8mm	50
5024	stepped olive 10mm	50
5025	stepped olive 12mm	40
5026	stepped olive 13mm	25
5027	stepped olive 14mm	20
5028	stepped olive 15mm	20
5031	barrel olive 4mm	50
5032	barrel olive 6mm	50
5033	barrel olive 8mm	50
5034	barrel olive 10mm	50
5035	barrel olive 12mm	40
5036	barrel olive 13mm	25
5037	barrel olive 14mm	20
5038	barrel olive 15mm	20

Voss 230 Range - MSK470		
Part No.	Description	Qty
4700	clip ng8 230	10
4701	clip ng12 230	10
4702	male nut ng8 230	5
4703	male nut ng12 230	5
4712	adaptor ng12 - m16x1.5 230	2
4714	adaptor ng12 - m22x1.5 230	2
4720	repair kit ng8 230	3
4721	repair kit ng12 230	3
4740	straight connector ng8 - 6x1mm 230	3
4741	straight connector ng8 - 8x1mm 230	3
4742	straight connector ng12 - 6x1mm 230	3
4743	straight connector ng12 - 8x1mm 230	3
4744	straight connector ng12 - 12x1.5mm 230	3
4746	elbow ng8 - 6x1mm 230	3
4747	elbow ng8 - 8x1mm 230	3
4748	elbow ng12 - 6x1mm 230	3
4749	elbow ng12 - 8x1mm 230	3
4750	elbow ng12 - 12x1.5 230	3
4751	elbow ng12 - 16x2mm 230	2

Note: Contents are subject for change

Voss 232 Range - MSK475		
Part No.	Description	Qty
4754	straight connector ng8 - 6x1mm 232	5
4755	straight connector ng8 - 8x1mm 232	4
4756	straight connector ng12 - 6x1mm 232	5
4757	straight connector ng12 - 8x1mm 232	3
4758	straight connector ng12 - 12x1.5mm 232	5
4759	male nut ng8 232	10
4760	male nut ng12 232	8
4762	elbow ng8 - 8x1mm 232	3
4763	elbow ng12 - 6x1mm 232	3
4764	elbow ng12 - 8x1mm 232	5
4765	elbow ng12 - 12x1.5mm 232	5
4768	adaptor ng8 - m16x1.5 232	5
4769	adaptor ng12 - m16x1.5 232	5
4770	adaptor ng12 - m22x1.5 232	5

Wira Push In Range - MSK703		
Part No.	Description	Qty
7031	p/i end-fitting 8x1mm (m14x1.5)	9
7032	p/i end-fitting 9x1.5mm (m16x1.5)	4
7033	p/i end-fitting 10x1.25mm (m16x1.5)	17
7035	p/i end-fitting 12x1.5mm (m18x1.5)	11
7050	straight stud m16x1.5 - 8x1mm	3
7051	straight stud m22x1.5 - 8x1mm	3
7057	straight stud m12x1.5 - 10x1.25mm	2
7643	thrust ring m16	11
7649	nitrile o ring m16	11
7868G	adaptor male/male m16x1.5 - m16x1.5	4
7645	thrust ring m22	7
7651	nitrile o ring m22	7
7869G	adaptor male/male m16x1.5 - m22x1.5	3
2023	coil end adaptor m18x1.5 - m16x1.5	3
2022	coil end adaptor m18x1.5 - m22x1.5	2
7681G	tube nut 8mm (m14x1.5)	-4
7691	cutting ring 8mm	-4
7734G	straight connector 8x1mm - 8x1mm	2
7114	straight connector 10x1.25mm - 10x1.25mm	2
7116	straight connector 12x1.5mm - 12x1.5mm	2
7641	thrust ring m12x1.5	3
7647	nitrile o ring m12 (10x2.5)	3
7671G	locknut m12x1.5	3
ZAC7781G	elbow stud m12x1.5 - 10mm	3
7673G	locknut m16x1.5	4
ZAC7783G	elbow body m16x1.5 - 10mm gold	2
7675G	locknut m22x1.5	2
ZAC7784G	elbow body m22x 1.5 - 10mm gold	1
ZAC7789G	elbow stud m16x1.5 - 12mm	2
ZAC7785G	elbow body m22x 1.5 - 12mm	1

Norgren Fleet Fit Push-in - MSK650		
Part No.	Description	Qty
6502	straight connector 6x1mm - 6x1mm	10
6504	straight connector 8x1mm - 8x1mm	10
6506	straight connector 10mm - 10mm	9
6508	straight connector 12x1.5mm - 12x1.5mm	5
6512	straight connector 16x2mm - 16x2mm	2
6570	straight stud m12x1.5 - 8x1mm	10
6572	straight stud m16x1.5 - 8x1mm	6
6577	straight stud m12x1.5 - 10mm	10
6579	straight stud m16x1.5 - 10mm	6
6580	straight stud m22x1.5 - 10mm	4
6586	straight stud m16x1.5 - 12x1.5mm	6
6610	elbow (90°) stud m12x1.5 - 10mm	4
6613	elbow (90°) stud m16x1.5 - 10mm	3
6614	elbow (90°) stud m22x1.5 - 10mm	2
6619	elbow (90°) stud m16x1.5 - 12x1.5mm	2
6762	straight stud 1/4bsp - 10mm	5

Sealing Rings - MSK764		
Part No.	Description	Qty
7630	aluminium seal m10	20
7631	aluminium seal m12	30
7632	aluminium seal m14	20
7633	aluminium seal m16	30
7634	aluminium seal m18	20
7635	aluminium seal m22	30
7640	thrust ring m10	50
7641	thrust ring m12x1.5	75
7642	thrust ring m14	50
7643	thrust ring m16	100
7644	thrust ring m18	20
7645	thrust ring m22	70
7646	nitrile o ring m10	50
7647	nitrile o ring m12 (10x2.5)	75
7648	nitrile o ring m14	50
7649	nitrile o ring m16	100
7650	nitrile o ring m18	20
7651	nitrile o ring m22	70
7652	copper seal m10	20
7653	copper seal m12	30
7654	copper seal m14	20
7655	copper seal m16	30
7656	copper seal m18	20
7657	copper seal m22	30
7664	bonded rubber seal m10	20
7665	bonded rubber seal m12	20
7666	bonded rubber seal m14	20
7667	bonded rubber seal m16	20
7668	bonded rubber seal m18	20
7669	bonded rubber seal m22	15

Note: Contents are subject for change

Maxi-Stor Assorted Box Content

Thread Adaptors - MSK760		
Part No.	Description	Qty
7602	adaptor male/female m22x1.5 - 1/4bsp	5
7604	adaptor male/female m22x1.5 - m16x1.5	12
7606	adaptor male/female m16x1.5 - 1/4bsp	12
7607	adaptor male/female 1/2bsp - m16x1.5	5
7609G	adaptor female/female m22x1.5 - m22x1.5	4
7610G	adaptor female/female m16x1.5 - m16x1.5	4
7611	adaptor male/female 1/4bsp - m16x1.5	5
7613	adaptor male/female 1/2bsp - m22x1.5	4
7614	adaptor male/female m22x1.5 - 1/2bsp	4
7615	adaptor male/female 3/8bsp - m16x1.5	5
7616	adaptor male/female m16x1.5 - 3/8bsp	4
7617	adaptor male/female m16x1.5 - m22x1.5	4
7618	adaptor male/female m16x1.5 - 1/2bsp	3

Wira Compression Range - MSK770		
Part No.	Description	Qty
7690	cutting ring 6mm	35
7691	cutting ring 8mm	50
7692	cutting ring 10mm	51
7693	cutting ring 12mm	37
7717G	straight stud m12x1.5 - 10mm	5
7682G	tube nut 10mm (m16x1.5)	16
7868G	adaptor male/male m16x1.5 - m16x1.5	6
7869G	adaptor male/male m16x1.5 - m22x1.5	5
2023	coil end adaptor m18x1.5 - m16x1.5	5
7683G	tube nut 12mm (m18x1.5)	12
2022	coil end adaptor m18x1.5 - m22x1.5	4
7733G	straight connector 6x1mm - 6x1mm	5
7734G	straight connector 8x1mm - 8x1mm	5
7735G	straight connector 10x1.25mm - 10x1.25mm	5
7736G	straight connector 12x1.5mm - 12x1.5mm	3
7738G	straight connector 16x2mm - 16x2mm	1
7673G	locknut m16x1.5	6
ZAC7783G	elbow body m16x1.5 - 10mm gold	3
7675G	locknut m22x1.5	2
ZAC7784G	elbow body m22x 1.5 - 10mm gold	2
ZAC7789G	elbow stud m16x1.5 - 12mm	3
7889G	tee female m16x1.5	2

Truck Repair Kit - MSK803		
Part No.	Description	Qty
7651	nitrile o ring m22	3
ZAC4499	bulkhead m22x1.5 male/male (m16x1.5 female)	1
ZAC4642	locknut m22 x 1.5	2
4505	straight stud m16x1.5 - 6x1mm p/i	4
4508	straight stud 8x1mm - m12x1.5 p/i	4
4510	straight stud 8x1mm - m16x1.5 p/i	4
4515	straight stud m16x1.5 - 10x1mm p/i	4
4516	straight stud m22x1.5 - 10x1mm p/i	4
4529	straight stud m16x1.5 - 12x1.5mm p/i	4
4530	straight stud m22x1.5 - 12x1.5mm p/i	4
4533	straight stud m22x1.5 - 15x1.5mm p/i	2
4578	elbow (90°) swivel 45deg m16x1.5 - p5 p/i	4
4580	elbow (90°) swivel m16x1.5 - p5	4
4590	tee swivel centre p5 - m16x1.5	3
4592	tee swivel onrun p5 - m16x1.5	3
4616	straight swivel p5 - m12x1.5	4
4618	straight swivel p5 - m16x1.5	4
4619	straight swivel p5 - m22x1.5	4
ZAC4633	bulkhead m16x1.5 - m22x1.5 (m16x1.5 female)	1
4634	f fitting m16 - p5 swivel	1
7621	plug m12x1.5	4
7622	plug m16x1.5	4
7623	plug m22x1.5	4

Raufoss Newline Fittings - MSK802		
Part No.	Description	Qty
4662	tube release tool 6x1mm	1
4663	tube release tool 8x1mm	1
4664	tube release tool 10x1mm	1
4665	tube release tool 12x1.5mm	1
6921	circlip pliers 150mm (6") external	1
R02020600	threadless coupling 6x1mm (regular)	2
R02020800	threadless coupling 8x1mm (regular)	2
R02021002	threadless coupling 10x1.25mm (reg)	2
R02021200	threadless coupling 12x1.5mm (reg)	2
R03020600	integral elbow (90°) threadless (reg) 6x1mm	2
R03020800	integral elbow (90°) threadless (reg) 8x1mm	2
R03021002	integral elbow (90°) threadless (reg) 10x1.25mm	2
R03021200	integral elbow (90°) threadless (reg) 12x1.5mm	2
R10021200	straight swivel m12x1.5 - threadless (regular)	3
R10021400	straight swivel m14x1.5 - threadless (regular)	2
R10021600	straight swivel m16x1.5 - threadless (regular)	3
R10022200	straight swivel m22x1.5 - threadless (regular)	3
R32000000	elbow (90°) female threadless (regular)	2
R52000000	tee female threadless (regular)	2
R60020000	threadless test point (regular)	1

Note: Contents are subject for change

Raufoss Newline Fittings - MSK805		
Part No.	Description	Qty
4566C	straight connector 6x1mm - 6x1mm	2
4567C	straight connector 8x1mm - 8x1mm	2
4571C	straight connector 12x1.5mm - 12x1.5mm	2
4662	tube release tool 6x1mm	1
4663	tube release tool 8x1mm	1
4664	tube release tool 10x1mm	1
4665	tube release tool 12x1.5mm	1
4666	tube release tool 15x1.5mm	1
4667	tube release tool 16x2mm	1
R01061200	straight stud m12x1.5 - 6x1mm	4
R01061600	straight stud m16x1.5 - 6x1mm	2
R01062200	straight stud m22x1.5 - 6x1mm	2
R01081200	straight stud m12x1.5 - 8x1mm	4
R01081600	straight stud m16x1.5 - 8x1mm	4
R01082200	straight stud m22x1.5 - 8x1mm	4
R01101202	straight stud m12x1.5 - 10x1.25mm	2
R01101602	straight stud m16x1.5 - 10x1.25mm	4
R01102202	straight stud m22x1.5 - 10x1.25mm	2
R01121200	straight stud m12x1.5 - 12x1.5mm	2
R01121600	straight stud m16x1.5 - 12x1.5mm	4
R01122200	straight stud m22x1.5 - 12x1.5mm	2
R01152200	straight stud m22x1.5 - 15x1.5mm	1
R01162200	straight stud m22x1.5 - 16x2mm	1

Camozzi C1 Range - MSK812		
Part No.	Description	Qty
CC4573	elbow (90°) swivel c1 - 6x1mm	2
CC4574	elbow (90°) swivel c1 - 8x1mm	4
CC4576	elbow (90°) swivel c1 - 10x1.5mm	4
CC4577	elbow (90°) swivel c1 - 12x1.5mm	4
CC4579	elbow (90°) swivel m12x1.5 - c1	2
CC4580	elbow (90°) swivel m16x1.5 - c1	4
CC4589	tee swivel centre c1 - m12x1.5	4
CC4590	tee swivel centre c1 - m16x1.5	4
CC4591	tee side swivel c1 - m12x1.5	4
CC4592	tee side swivel c1 - m16x1.5	4
CC4615	straight swivel m10x1 - c1	2
CC4616	straight swivel m12x1.5 - c1	4
CC4617	straight swivel m14x1.5 - c1	2
CC4618	straight swivel m16x1.5 - c1	4
CC4619	straight swivel m22x1.5 - c1	4
CC7406	release tool 6mm	2
CC7408	release tool 8mm	2
CC7410	release tool 10mm	2
CC7412	release tool 12mm	2

Emergency Repair Kit - MSK811		
Part No.	Description	Qty
7651	nitrile o ring m22	8
ZAC4499	bulkhead m22x1.5 male/male (m16x1.5 female)	1
ZAC4642	locknut m22 x 1.5	1
4594	tee female threaded m16x1.5mm	1
4595	tee female threaded m22x1.5mm	1
6910	tube cutters	1
7609G	adaptor female/female m22x1.5 - m22x1.5	1
7610G	adaptor female/female m16x1.5 - m16x1.5	1
7622	plug m16x1.5	2
7623	plug m22x1.5	2
7643	thrust ring m16	6
7645	thrust ring m22	6
7649	nitrile o ring m16	6
7835T	test point male m16x1.5 + thrust ring & o - ring	1
7673G	locknut m16x1.5	1
ZAC7750G	bulkhead connector 10mm od gold	1
CC4503	straight stud m12x1.5 - 6x1mm	1
CC4504	straight stud m14x1.5 - 6x1mm	1
CC4505	straight stud m16x1.5 - 6x1mm	2
CC4506	straight stud m22x1.5 - 6x1mm	2
CC4508	straight stud m12x1.5 - 8x1mm	1
CC4509	straight stud m14x1 - 8x1mm	1
CC4510	straight stud m16x1.5 - 8x1mm	2
CC4511	straight stud m22x1.5x1 - 8x1mm	2
CC4524	straight stud m16x1.5 - 10x1.5mm	2
CC4525	straight stud m22x1.5 - 10x1.5mm	2
CC4529	straight stud m16x1.5 - 12x1.5mm	2
CC4530	straight stud m22x1.5 - 12x1.5mm	2
CC6502	straight connector 6x1mm - 6x1mm	2
CC6504	straight connector 8x1mm - 8x1mm	2
CC6506.5	straight connector 10x1.5 mm - 10x1.5 mm	2
CC6508	straight connector 12x1.5mm - 12x1.5mm	2

Note: Contents are subject for change

Standard Assorted Box Content

Camozzi C Truck Range - MSK813		
Part No.	Description	Qty
CC4508	straight stud m12x1.5 - 8x1mm	4
CC4510	straight stud m16x1.5 - 8x1mm	4
CC4513	straight stud m12x1.5 - 10x1mm	4
CC4515	straight stud m16x1.5 - 10x1mm	4
CC4516	straight stud m22x1.5 - 10x1mm	3
CC4519	straight stud m16x1.5 - 10x1.25mm	4
CC4522	straight stud m12x1.5 - 10x1.5mm	4
CC4524	straight stud m16x1.5 - 10x1.5mm	4
CC4525	straight stud m22x1.5 - 10x1.5mm	3
CC4529	straight stud m16x1.5 - 12x1.5mm	3
CC6502	straight connector 6x1mm - 6x1mm	6
CC6504	straight connector 8x1mm - 8x1mm	5
CC6506	straight connector 10x1mm - 10x1mm	4
CC6506.5	straight connector 10x1.5 mm - 10x1.5 mm	4
CC6508	straight connector 12x1.5mm - 12x1.5mm	6
CC6511	straight connector 15x1.5mm - 15x1.5mm	2
CC6610	elbow (90°) stud m12x1.5 - 10x1mm	5
CC6610.5	elbow (90°) stud m12x1.5 - 10x1.5mm	5
CC6613	elbow (90°) stud m16x1.5 - 10x1mm	4
CC6613.5	elbow (90°) stud m16x1.5 - 10x1.5mm	4
CC6614	elbow (90°) stud m22x1.5 - 10x1mm	3
CC6614.5	elbow (90°) stud m22x1.5 - 10x1.5mm	3
CC6619	elbow (90°) stud m16x1.5 - 12x1.5mm	3

Coil End Adaptors - 2026		
Part No.	Description	Qty
2021	coil end adaptor m18x1.5 - 1/2bsp	6
2022	coil end adaptor m18x1.5 - m22x1.5	6
2023	coil end adaptor m18x1.5 - m16x1.5	4
2024	coil adaptor m18x1.5 (34mm)	4
2025	coil adaptor m16x1.5 (34mm)xm18x15	4

Worm Drive Clips - 2030A		
Part No.	Description	Qty
2031	hose clip (OOO)	7
2032	hose clip (MOO)	10
2033	hose clip (OO)	9
2035	hose clip (OX)	7
2036	hose clip (1A)	7
2038	hose clip (1X)	4

Plastic Push In Straights Metric - 2420		
Part No.	Description	Qty
2417	straight connector 15x1.5mm - 15x1.5mm	2
4410	straight connector 4x1mm - 4x1mm	5
4412	straight connector 6x1mm - 6x1mm	5
4413	straight connector 8x1mm - 8x1mm	5
4415	straight connector 10mm - 10mm	5
4416	straight connector 12x1.5mm - 12x1.5mm	5

Plastic Push In Straights & Elbows - 2430		
Part No.	Description	Qty
4441	straight stud 1/8bspt - 4x1mm	4
4442	straight stud 1/8bspt - 6x1mm	4
4443	straight stud 1/4bspt - 6x1mm	4
4449	straight stud 1/8bspt - 8x1mm	4
4461	elbow (90°) swivel 1/8bspt - 4x1mm	4
4462	elbow (90°) swivel 1/8bspt - 6x1mm	4
4463	elbow (90°) swivel 1/4bspt - 6x1mm	4

Plastic Push In Straights Imperial - 2040		
Part No.	Description	Qty
4421	straight connector 5/32 - 5/32	5
4422	straight connector 3/16 - 3/16	5
4423	straight connector 1/4 - 1/4	5
4424	straight connector 5/16 - 5/16	5
4425	straight connector 3/8 - 3/8	5
4426	straight connector 1/2 - 1/2	5

Plastic Push In Reducers & Stems - 2490		
Part No.	Description	Qty
2431	straight connector 6x1mm - 4x1mm	4
2432	straight connector 12x1.5mm - 10mm	3
2433	straight connector 8x1mm - 6x1mm	2
2434	straight connector 10mm - 6x1mm	2
2435	straight connector 10mm - 8x1mm	4
2492	stem reducer 6mm - 4mm	4
2495	stem reducer 8mm - 6mm	4
2497	stem reducer 10mm - 8mm	3
2498	stem reducer 12mm - 8mm	3
2499	stem reducer 12mm - 10mm	2
2808	stem y connector 8mm	2
2809	stem y connector 10mm	1

Imperial Stepped Olives - 3000		
Part No.	Description	Qty
5001	stepped olive 1/8	50
5002	stepped olive 5/32	25
5003	stepped olive 3/16	25
5004	stepped olive 1/4	25
5005	stepped olive 5/16	25
5006	stepped olive 3/8	25
5007	stepped olive 1/2	25
5008	stepped olive 5/8	25

Note: Contents are subject for change

Metric Plastic Plugs - 2720		
Part No.	Description	Qty
2731	plug 4mm	5
2733	plug 6mm	5
2734	plug 8mm	5
2735	plug 10mm	5
2736	plug 12mm	5
2737	plug 15mm	5

Metric Stepped Olives - 3020		
Part No.	Description	Qty
5021	stepped olive 4mm	25
5022	stepped olive 6mm	25
5023	stepped olive 8mm	25
5024	stepped olive 10mm	25
5025	stepped olive 12mm	25
5026	stepped olive 13mm	20
5027	stepped olive 14mm	20
5028	stepped olive 15mm	20
5091	stepped olive 11mm	20
5099	stepped olive 9mm	20

Tube Supports - 3100		
Part No.	Description	Qty
5151	tube support 4mm	50
5152	tube support 6mm	50
5153	tube support 7mm	50
5154	tube support 8mm	50
5155	tube support 9mm	50
5158	tube support 12mm	20
5159	tube support 14mm	15
5160	tube support 7.5mm	50

Pro Release Tool Assorted Box - 4678A		
Part No.	Description	Qty
4672	tube release tool pro 6x1mm	1
4673	tube release tool pro 8x1mm	1
4674	tube release tool pro 10x1mm	1
4675	tube release tool pro 12x1.5mm	1
4677	tube release tool pro 16x2mm	1
R99150200	tube release tool pro 15mm	1

Brass Push In Straights - 6500A		
Part No.	Description	Qty
2801	straight connector 4x1mm - 4x1mm	3
6504	straight connector 8x1mm - 8x1mm	3
6506	straight connector 10mm - 10mm	5
6508	straight connector 12x1.5mm - 12x1.5mm	2
6665	straight connector 1/4 - 1/4	5
6667	straight connector 3/8 - 3/8	3
6668	straight connector 1/2 - 1/2	3

Imperial Barrel Olives - 3010		
Part No.	Description	Qty
5011	barrel olive 1/8	25
5012	barrel olive 5/32	25
5013	barrel olive 3/16	25
5014	barrel olive 1/4	25
5015	barrel olive 5/16	25
5016	barrel olive 3/8	25
5017	barrel olive 1/2	25
5018	barrel olive 5/8	25

Metric Barrel Olives - 3030		
Part No.	Description	Qty
5031	barrel olive 4mm	25
5032	barrel olive 6mm	25
5033	barrel olive 8mm	25
5034	barrel olive 10mm	25
5035	barrel olive 12mm	25
5036	barrel olive 13mm	25
5037	barrel olive 14mm	25
5038	barrel olive 15mm	25

Imperial Straight Compression - 3200		
Part No.	Description	Qty
5211	straight connector 1/8	3
5222	straight connector 5/32	3
5233	straight connector 3/16	5
5244	straight connector 1/4	8
5255	straight connector 5/16	5
5266	straight connector 3/8	5
5277	straight connector 1/2	3

Metric Straight Compression - 3300		
Part No.	Description	Qty
5311	straight connector 4mm	5
5322	straight connector 6mm	5
5333	straight connector 8mm	5
5344	straight connector 10mm	5
5355	straight connector 12mm	4
5366	straight conn 13mm	1
5377	straight connector 14mm	1
5388	straight connector 15mm	1

Brass Push In Straights - 6500M		
Part No.	Description	Qty
6502	straight connector 6x1mm - 6x1mm	5
6504	straight connector 8x1mm - 8x1mm	5
6506	straight connector 10mm - 10mm	5
6508	straight connector 12x1.5mm - 12x1.5mm	5
6511	straight connector 15x1.5mm - 15x1.5mm	2
6512	straight connector 16x2mm - 16x2mm	2

Note: Contents are subject for change

Standard Assorted Box Content

Brass Push In Straights - 6500P		
Part No.	Description	Qty
2801	straight connector 4x1mm - 4x1mm	4
2802	straight connector 5x1mm - 5x1mm	4
6502	straight connector 6x1mm - 6x1mm	5
6504	straight connector 8x1mm - 8x1mm	5
6506	straight connector 10mm - 10mm	5
6508	straight connector 12x1.5mm - 12x1.5mm	5
6511	straight connector 15x1.5mm - 15x1.5mm	1
6512	straight connector 16x2mm - 16x2mm	1

Brass Push In Straight Studs - 6600A		
Part No.	Description	Qty
6565	straight stud m12x1.5 - 6x1mm	2
6570	straight stud m12x1.5 - 8x1mm	2
6572	straight stud m16x1.5 - 8x1mm	4
6577	straight stud m12x1.5 - 10mm	2
6579	straight stud m16x1.5 - 10mm	4
6580	straight stud m22x1.5 - 10mm	2
6586	straight stud m16x1.5 - 12x1.5mm	4
6587	straight stud m22x1.5 - 12x1.5mm	2

Male Brake Pipe Nuts - 7000		
Part No.	Description	Qty
8001	male nut 3/8x24tpi 3/16od	20
8002	male nut 3/8x20tpi 3/16 od	10
8003	male nut long 10x1.25 3/16od	10
8004	male nut short 10x1.25 3/16 od	10
8005	male nut long 10x1mm 3/16 od	10
8006	male nut tte 10x1mm 3/16 od	10
8007	male nut short 10x1mm 3/16 od	20
8008	male nut datsun 10x1mm 3/16 od	10
8009	male nut 12x1mm 3/16 od	10
8015	male nut 7/16x24tpi 3/16 od	10
8019	male nut 7/16x20tpi 3/16 od	10

Wira End fittings - 7030A		
Part No.	Description	Qty
7030	p/i end-fitting 6x1mm (m12x1.5)	4
7031	p/i end-fitting 8x1mm (m14x1.5)	4
7032	p/i end-fitting 9x1.5mm (m16x1.5)	2
7033	p/i end-fitting 10x1.25mm (m16x1.5)	5
7033.1	p/i end-fitting 10x1mm (m16x1.5)	5
7033.5	p/i end-fitting 10x1.5mm (m16x1.5)	5
7034	p/i end-fitting 11x1.5mm (m18x1.5)	2
7035	p/i end-fitting 12x1.5mm (m18x1.5)	5
7037	p/i end-fitting 15x1.5mm (m22x1.5)	2
7039	p/i end-fitting 18x2mm (m26x1.5)	2

Female Brake Pipe Fittings - 7100		
Part No.	Description	Qty
8101	female nut 3/8x24tpi 3/16 od	20
8102	female nut 10x1mm 3/16 od	20
8200	male/male connector 10x1mm 3/16 od	5
8201	male/male connector 3/8x24tpi 3/16	5
8303	3 way connector 3/8x24tpi 3/16 od	2
8304	4 way connector 3/8x24tpi 3/16 od	2
8305	3 way connector 10x1mm 3/16 od	2

Grease Nipples - 7500		
Part No.	Description	Qty
8501	grease nipple 1/8bsp straight	20
8502	grease nipple 1/4bsf straight	20
8503	grease nipple 5/16bsf straight	20
8505	grease nipple 1/4unf long	20
8520	grease nipple 1/8bsp 45°	10
8521	grease nipple 1/4bsf 45°	10
8522	grease nipple 1/4unf 45°	10
8530	grease nipple 1/8bsp button	10
8531	grease nipple 1/4bsp button	20
8532	grease nipple 3/8bsf button	10

M/F Adaptors Metric/Imp - 7589		
Part No.	Description	Qty
7602	adaptor male/female m22x1.5 - 1/4bsp	5
7603	adaptor male/female m22x1.5 - 3/8bsp	5
7604	adaptor male/female m22x1.5 - m16x1.5	5
7606	adaptor male/female m16x1.5 - 1/4bsp	5
7614	adaptor male/female m22x1.5 - 1/2bsp	4
7616	adaptor male/female m16x1.5 - 3/8bsp	5
7617	adaptor male/female m16x1.5 - m22x1.5	4
7618	adaptor male/female m16x1.5 - 1/2bsp	3

M/F Adaptors Metric/Imp - 7590		
Part No.	Description	Qty
7598	adaptor male/female 1/2bspt - m18x1.5	4
7599	adaptor male/female 1/4bsp - 3/8bsp	5
7607	adaptor male/female 1/2bsp - m16x1.5	5
7611	adaptor male/female 1/4bsp - m16x1.5	5
7612	adaptor male/female 1/4bsp - m22x1.5	2
7613	adaptor male/female 1/2bsp - m22x1.5	4
7615	adaptor male/female 3/8bsp - m16x1.5	5
7619	adaptor male/female 3/8bsp - m22x1.5	2

Note: Contents are subject for change

Aluminium Seals - 7635A

Part No.	Description	Qty
7630	aluminium seal m10	20
7631	aluminium seal m12	20
7632	aluminium seal m14	20
7633	aluminium seal m16	50
7634	aluminium seal m18	20
7635	aluminium seal m22	50

Metric Cutting Rings - 7639

Part No.	Description	Qty
7690	cutting ring 6mm	20
7691	cutting ring 8mm	20
7692	cutting ring 10mm	35
7693	cutting ring 12mm	20
7694	cutting ring 15mm	20
7695	cutting ring 16mm	20
7696	cutting ring 18mm	20

Bonded Seals - 7669A

Part No.	Description	Qty
7664	bonded rubber seal m10	20
7665	bonded rubber seal m12	20
7666	bonded rubber seal m14	20
7667	bonded rubber seal m16	40
7668	bonded rubber seal m18	20
7669	bonded rubber seal m22	40

Raufoss Tube Release Tools - R99000000

Part No.	Description	Qty
R99060200	pro release tool 6mm	1
R99080200	pro release tool 8mm	1
R99100200	pro release tool 10mm	1
R99120200	pro release tool 12mm	1

Plastic Push In Tees Metric - Z4450

Part No.	Description	Qty
4451	tee connector 4mm	4
4452	tee connector 5mm	2
4453	tee connector 6mm	5
4454	tee connector 8mm	5
4455	tee connector 10mm	4
4456	tee connector 12mm	2
2457	tee connector 15mm	1

Thrust & O Ring - 7638

Part No.	Description	Qty
7641	thrust ring m12x1.5	25
7642	thrust ring m14	25
7643	thrust ring m16	25
7645	thrust ring m22	25
7647	nitrile o ring m12 (10x2.5)	25
7648	nitrile o ring m14	25
7649	nitrile o ring m16	25
7651	nitrile o ring m22	25

Copper Seals - 7657A

Part No.	Description	Qty
7652	copper seal m10	20
7653	copper seal m12	20
7654	copper seal m14	20
7655	copper seal m16	50
7656	copper seal m18	20
7657	copper seal m22	20

Camozzi Release Tools - CC7400A

Part No.	Description	Qty
CC7406	Release Tool 6mm	3
CC7408	Release Tool 8mm	3
CC7410	Release Tool 10mm	3
CC7412	Release Tool 12mm	3

Plastic Push In Unequal Straights - Z2430

Part No.	Description	Qty
2431	straight connector 6mm-4mm	5
2432	straight connector 12mm-10mm	5
2433	straight connector 8mm-6mm	5
2434	straight connector 10mm-6mm	5
2435	straight connector 10mm-8mm	5

Plastic Push In Elbows Metric - Z4470

Part No.	Description	Qty
4471	elbow connector 4mm	3
4473	elbow connector 6mm	4
4474	elbow connector 8mm	4
4475	elbow connector 10mm	4
4476	elbow connector 12mm	4

Note: Contents are subject for change

Megabox Assorted Box Content

Raufoss Newline Range - MSK820		
Part No.	Description	Qty
4662	tube release tool 6x1mm	1
4663	tube release tool 8x1mm	1
4664	tube release tool 10x1mm	1
4665	tube release tool 12x1.5mm	1
6921	circlip pliers 150mm (6") external	1
R01061200	straight stud m12x1.5 - 6x1mm	4
R01061600	straight stud m16x1.5 - 6x1mm	2
R01062200	straight stud m22x1.5 - 6x1mm	2
R01081200	straight stud m12x1.5 - 8x1mm	4
R01081600	straight stud m16x1.5 - 8x1mm	4
R01082200	straight stud m22x1.5 - 8x1mm	4
R01101602	straight stud m16x1.5 - 10x1.25mm	4
R01102202	straight stud m22x1.5 - 10x1.25mm	2
R01121600	straight stud m16x1.5 - 12x1.5mm	4
R01122200	straight stud m22x1.5 - 12x1.5mm	2
R01152200	straight stud m22x1.5 - 15x1.5mm	1
R01162200	straight stud m22x1.5 - 16x2mm	1
R02020600	threadless coupling 6x1mm (regular)	2
R02020800	threadless coupling 8x1mm (regular)	2
R02021002	threadless coupling 10x1.25mm (regular)	2
R02021200	threadless coupling 12x1.5mm (regular)	2
R03020600	integral elbow (90°) threadless (reg) 6x1mm	2
R03020800	integral elbow (90°) threadless (reg) 8x1mm	2
R03021002	integral elbow (90°) threadless (reg) 10x1.25	2
R03021200	integral elbow (90°) threadless (reg) 12x1.5	2
R10021200	straight swivel m12x1.5 - threadless (reg)	3
R10021400	straight swivel m14x1.5 - threadless (reg)	2
R10021600	straight swivel m16x1.5 - threadless (reg)	3
R10022200	straight swivel m22x1.5 - threadless (reg)	3
R22000000	elbow (45°) female threadless (regular)	2
R32000000	elbow (90°) female threadless (regular)	2
R52000000	tee female threadless (regular)	2
R60020000	threadless test point (regular)	1

Camozzi - MSK830		
Part No.	Description	Qty
CC4510	straight stud m16x1.5 – 8x1mm	2
CC4515	straight stud m16x1.5 – 10x1mm	2
CC4516	straight stud m22x1.5 – 10x1mm	2
CC4519	straight stud m16x1.5 – 10x1.25mm	2
CC4522	straight stud m12x1.5 – 10x1.5mm	2
CC4524	straight stud m16x1.5 – 10x1.5mm	2
CC4525	straight stud m22x1.5 – 10x1.5mm	2
CC4529	straight stud m16x1.5 – 12x1.5mm	3
CC4573	elbow (90°) swivel c1 – 6x1mm	2
CC4574	elbow (90°) swivel c1 – 8x1mm	2
CC4575	elbow (90°) swivel c1 – 10x1.25mm	2
CC4576	elbow (90°) swivel c1 – 10x1.5mm	2
CC4577	elbow (90°) swivel c1 – 12x1.5mm	2
CC4580	elbow (90°) swivel m16x1.5 – c1	2
CC4590	tee swivel centre c1 – m16x1.5	2
CC4592	tee side swivel c1 – m16x1.5	2
CC4616	straight swivel m12x1.5 – c1	2
CC4617	straight swivel m14x1.5 – c1	2
CC4618	straight swivel m16x1.5 – c1	4
CC4619	straight swivel m22x1.5 – c1	4
CC6502	straight connector 6x1mm – 6x1mm	2
CC6504	straight connector 8x1mm – 8x1mm	4
CC6506	straight connector 10x1mm – 10x1mm	2
CC6506.5	straight connector 10x1.5 mm – 10x1.5 mm	2
CC6508	straight connector 12x1.5mm – 12x1.5mm	2
CC6511	straight connector 15x1.5mm – 15x1.5mm	2
CC6610	elbow (90°) stud m12x1.5 – 10x1mm	2
CC6610.5	elbow (90°) stud m12x1.5 – 10x1.5mm	2
CC6613	elbow (90°) stud m16x1.5 – 10x1mm	2
CC6613.5	elbow (90°) stud m16x1.5 – 10x1.5mm	2
CC6614	elbow (90°) stud m22x1.5 – 10x1mm	2
CC6614.25	elbow (90°) stud m22x1.5 – 10x1.25mm	2
CC6614.5	elbow (90°) stud m22x1.5 – 10x1.5mm	2
CC6619	elbow (90°) stud m16x1.5 – 12x1.5mm	2
CC7406	release tool 6mm	1
CC7408	release tool 8mm	1
CC7410	release tool 10mm	1
CC7412	release tool 12mm	1

Note: Contents are subject for change

Part No.	Description	Qty	Page	Part No.	Description	Qty	Page	Part No.	Description	Qty	Page
0101	male c coupling 1/2bsp	1	2.18	0300	ptfe tape (pk10)	10	4.8	0915	standard q/r coup 1/4bspm	1	3.11
0101	male c coupling 1/2bsp	1	2.18	0302	liquid sealant 50ml	1	2.3	0916	standard q/r coup 3/8bspm	1	3.11
0101M	male c coupling m22x1.5	1	2.18	0314	reducing bush 1/4x1/8	1	2.6	0917	standard q/r coup 1/2bspm	1	3.11
0102	female c coupling 1/2bsp	1	2.18	0314	reducing bush 1/4x1/8	1	4.7	0918	standard q/r coup 1/4bspf	1	3.11
0102	female c coupling 1/2bsp	1	2.18	0346	reducing bush 3/8x1/4	1	2.6	0919	standard q/r coup 3/8bspf	1	3.11
0102M	female c coupling m22x1.5	1	2.18	0346	reducing bush 3/8x1/4	1	4.7	0920	slimline q/r coup 1/4bspf	1	3.11
0103	male ca coupling 1/2bsp	1	2.18	0347	reducing bush 1/2x1/4	1	2.6	0921	slimline q/r coup 1/4bspm	1	3.11
0103M	male ca coupling m22x1.5	1	2.18	0347	reducing bush 1/2x1/4	1	4.7	0922	y connector 1/4bsp	1	3.14
0104	female ca coupling 1/2bsp	1	2.18	0349	reducing bush 3/4x1/4	1	2.6	0923	standard q/r 10mm hosetail	1	3.11
0104M	female ca coupling m22x1.5	1	2.18	0349	reducing bush 3/4x1/4	1	4.7	0924	y connector 3/8 bsp	1	3.14
0105	male self sealing valve 1/2bsp	1	2.18	0367	reducing bush 1/2x3/8	1	2.6	0925	bayonet 1/4bspm pk2	1	3.11
0105M	male self sealing valve m22x1.5	1	2.18	0367	reducing bush 1/2x3/8	1	4.7	0926	bayonet 3/8bspm pk2	1	3.11
0106	female self seal valve 1/2bsp	1	2.18	0369	reducing bush 3/4x3/8	1	2.6	0927	bayonet fitting male	1	3.11
0106	female self seal valve 1/2bsp	1	2.18	0369	reducing bush 3/4x3/8	1	4.7	0928	bayonet 1/4bspf pk2	1	3.11
0106M	female self sealing valve m22x1.5	1	2.18	0379	reducing bush 3/4x1/2	1	2.6	0929	bayonet hosetail 1/4 pkt2	1	3.11
0107	operating insert 1/2bsp	1	2.18	0379	reducing bush 3/4x1/2	1	4.7	0930	bayonet hosetail 5/16 pkt2	1	3.11
0107M	operating insert m22x1.5	1	2.18	0380	reducing bush 1"x1/2"	1	2.6	0931	bayonet hosetail 3/8 pkt2	1	3.11
0110	female c c/w insert 1/2bsp	1	2.18	0380	reducing bush 1"x1/2"	1	4.7	0932	large q/r coup 3/8bspm	1	3.14
0110M	female c c/w insert m22x1.5	1	2.18	0381	female tee 1/8	1	4.7	0933	large q/r coup 1/2bspm	1	3.14
0115	c coupling tester	1	2.19	0384	female tee 1/4	1	4.7	0934	large q/r coup 3/8bspf	1	3.14
0116	air brake test kit	1	8.10	0386	female tee 3/8	1	4.7	0935	large q/r coup 1/2bspf	1	3.14
0117	male dummy c coupling	1	2.19	0387	female tee 1/2	1	4.7	0936	large bayonet 3/8bspm	1	3.14
0117C	male dummy c coupling c/w chain	1	2.19	0389	female tee 3/4	1	4.7	0937	large bayonet 1/2bspm	1	3.14
0117WB	dummy coupling with bolt	1	2.19	0411	female socket 1/8	1	4.7	0938	large bayonet 3/8bspf	1	3.14
0118	female dummy c couplings	1	2.19	0444	female socket 1/4	1	4.7	0939	large bayonet hosetail 3/8id	1	3.14
0119R	c coupling lock	1	2.19	0446	female socket 1/4x3/8	1	4.7	0940	large bayonet hosetail 1/2id	1	3.14
0119RS	c coupling lock same key	1	2.19	0447	female socket 1/4x1/2	1	4.7	0943	hosetail 1/8bsp fem-6mmid	1	3.14
0119SK	c coupling lock spare key	1	2.19	0449	female socket 1/4x3/4	1	4.7	0947	hosetail 1/4bsp-1/2id pk10	10	3.14
0119VOR	c coupling lock (vehicle of road)	1	2.19	0466	female socket 3/8	1	4.7	0951	multifit coup 3/8bspm	1	3.11
0119VORS	c coupling lock (vehicle of road)	1	2.19	0467	female socket 3/8x1/2	1	4.7	0954	bayonet fitting female	1	3.11
0120	angled bulkhead m22x1.5m16x1.5	1	2.19	0477	female socket 1/2	1	4.7	0955	bayonet fitting female	1	3.11
0121	palm coupling 1/2bsp	1	2.20	0499	female socket 3/4	1	4.7	0956	slimline vertex coupling female	1	3.11
0122	palm coupling m22x1.5	1	2.20	0511	hexagon nipple 1/8	1	4.7	0957	slimline vertex coupling female	1	3.11
0125	in line filter m22x1.5	1	2.20	0544	hexagon nipple 1/4	1	4.7	0958	slimline vertex coupling male	1	3.11
0126	palm coupl self sealing m16x1.5	1	2.20	0546	hexagon nipple 1/4x3/8	1	4.8	0959	slimline vertex coupling male	1	3.11
0127	palm coupl self sealing m16x1.5	1	2.20	0547	hexagon nipple 1/4x1/2	1	4.8	0961	safe flow couplings male	1	3.12
0128	palm coupling yellow m22x1.5	1	2.20	0566	hexagon nipple 3/8	1	4.7	0962	safe flow couplings female	1	3.12
0129	palm coupling red m22x1.5	1	2.20	0567	hexagon nipple 3/8x1/2	1	4.8	0963	safe flow couplings female	1	3.12
0130	palm coupling yellow 1/2bsp	1	2.20	0577	hexagon nipple 1/2	1	4.7	0964	hosetail 3/8bsp-1/4id pk10	10	3.14
0131	palm coupling red 1/2bsp	1	2.20	0579	hexagon nipple 1/2x3/4	1	4.8	0965	hosetail 3/8bsp-5/16id pk10	10	3.14
0132	shut off tap 1/2bsp chrome	1	2.3	0599	hexagon nipple 3/4	1	4.7	0966	hosetail 3/8bsp-3/8id pk10	10	3.14
0132G	shut off tap 1/2bsp chrome gas	1	2.3	0644	female elbow 1/4	1	4.7	0967	hosetail 3/8bsp-1/2id pk10	10	3.14
0134	drain tap 1/4bsp chrome	1	2.4	0677	female elbow 1/2	1	4.7	0976	hosetail 1/2bsp-3/8id pk10	10	3.14
0135	drain tap 1/4npt c/w cable	1	2.3	0699	female elbow 3/4	1	4.7	0977	hosetail 1/2bsp-1/2id pk10	10	3.14
0136	butterfly drain tap 1/4bsp	1	2.4	0711	male/female elbow 1/8	1	4.7	0980	60series coup 1/4bspm	1	3.13
0137	shut off tap 1/4bsp chrome	1	2.3	0744	male/female elbow 1/4	1	4.7	0981	60series coup 3/8bspm	1	3.13
0138	shut off tap 3/8bsp chrome	1	2.3	0766	male/female elbow 3/8	1	4.7	0982	60series coup 1/2bspm	1	3.13
0139	shut off tap 3/4bsp chrome	1	2.3	0777	male/female elbow 1/2	1	4.7	0983	60series coup 1/4bspf	1	3.13
0141	shut off tap 1 1/4 chrome	1	2.3	0777.45	elbow male/female 1/2	1	4.8	0984	60series coup 3/8bspf	1	3.13
0142	drain tap 3/8npt c/w cable	1	2.3	0799	male/female elbow 3/4	1	4.7	0985	60series coup 1/2bspf	1	3.13
0143	drain tap 1/2npt c/w cable	1	2.3	0801	plug 1/8bsp	1	4.7	0986	60series adaptor 1/4bspm	1	3.13
0144	drain tap 1/8bsp chrome female	1	2.4	0804	plug 1/4bsp	1	4.7	0986	60series adaptor 1/4bspm	1	3.13
0146	polyethylene drum tap 2"bsp	1	8.6	0806	plug 3/8bsp	1	4.7	0987	60series adaptor 3/8bspm	1	3.13
0147	aero hdpe drum tap	1	8.6	0807	plug 1/2bsp	1	4.7	0987	60series adaptor 3/8bspm	1	3.13
0151R	male c coupling m22 red	1	2.17	0809	plug 3/4bsp	1	4.7	0991	60series bayonet hosetail 3/8id	1	3.13
0152B	female c c/w lifter black m22	1	2.17	0901	high flow coup 1/4bspm	1	3.12	0992	60series bayonet hosetail 1/2id	1	3.13
0152R	female c c/w lifter m22 yellow	1	2.17	0902	high flow coup 3/8bspm	1	3.12	0993	safety adaptor 3/8bspm	1	3.13
0155R	male c valve m22x1.5 yellow	1	2.17	0903	high flow coup 1/2bspm	1	3.12	1141	1/4od black nylon 30mtr	30m	6.7
0156R	female c c/w self sealing m22x1.5	1	2.17	0904	high flow coup 1/4bspf	1	3.12	1151	5/16od black nylon 30mtr	30m	6.7
0157	red p.v.c. cover for 0151	1	2.19	0905	high flow coup 3/8bspf	1	3.12	1161	3/8od black nylon 30mtr	30m	6.7
0158	yellow p.v.c. cover for 0152	1	2.19	0907	high flow bayonet 1/4bspm	1	3.12	1163	3/8od red nylon 30mtr	30m	6.7
0159	cable for 0157/0158	1	2.19	0908	high flow bayonet 3/8bspm	1	3.12	1164	3/8od yellow nylon 30mtr	30m	6.7
0160R	male c valve m16x1.5 yellow	1	2.17	0909	high flow bayonet 1/2bspm	1	3.12	1171	1/2od black nylon 30mtr	30m	6.7
0161R	female c valve m16x1.5 red	1	2.17	0910	high flow bayonet 1/4bspf	1	3.12	1211	4x1mm black nylon 15mtr	15m	6.6
0166	c coupling handles red & yell	1	2.17	0911	high flow bayonet 3/8bspf	1	3.11	1221	6x1mm black nylon 15mtr	15m	6.6
0171B	male c coupling m16x1.5 red	1	2.17	0913	high flow hosetail 3/8id	1	3.12	1223	6x1mm red nylon 15mtr	15m	6.6
0172B	female c c/w lifter m16x1.5	1	2.17	0914	high flow hosetail 1/2id	1	3.12	1223	6x1mm red nylon 15mtr	15m	6.6

Part No.	Description	Qty	Page	Part No.	Description	Qty	Page	Part No.	Description	Qty	Page
2406	straight conn 1/2 pk10	10	3.10	2610	straight stud 1/4bsp-10mm	10	3.6	2851	elbow swivel 1/8bsp-5mm	1	3.2
2410	straight conn 28mm pk5	5	3.6	2611	straight stud 3/8bsp-10mm	10	3.6	2852	elbow swivel 1/4bsp-5mm	1	3.2
2411	straight conn 4mm pk10	10	3.6	2612	straight stud 3/8bsp-12mm	10	3.6	2853	elbow swivel 1/8bsp-6mm	1	3.2
2412	straight conn 5mm pk10	10	3.6	2642	elbow swivel 1/8bsp-1/4	10	3.10	2854	elbow swivel 1/4bsp-6mm	1	3.2
2413	straight conn 6mm pk10	10	3.6	2661	elbow swivel 1/8bsp-4mm	10	3.7	2855	elbow swivel 3/8bsp-6mm	1	3.2
2414	straight conn 8mm pk10	10	3.6	2663	elbow swivel 1/8bsp-5mm	10	3.7	2856	elbow swivel 1/8bsp-8mm	1	3.2
2415	straight conn 10mm pk10	10	3.6	2664	elbow swivel 1/8bsp-6mm	10	3.7	2857	elbow swivel 1/4bsp-8mm	1	3.2
2416	straight conn 12mm pk10	10	3.6	2666	elbow swivel 1/4bsp-6mm	10	3.7	2858	elbow swivel 3/8bsp-8mm	1	3.2
2417	straight conn 15mm pk10	10	3.6	2667	elbow swivel 1/8bsp-8mm	10	3.7	2859	elbow swivel 1/2bsp-8mm	1	3.2
2418	straight conn 18mm pk5	5	3.6	2668	elbow swivel 1/4bsp-8mm	10	3.7	2860	elbow swivel 1/8bsp-10mm	1	3.2
2419	straight conn 22mm pk5	5	3.6	2670	elbow swivel 1/4bsp-10mm	10	3.7	2861	elbow swivel 1/4bsp-10mm	1	3.2
2420	assorted box plastic push in	1	3.5	2713	bulkhead 6mm mod pk10	10	3.7	2862	elbow swivel 3/8bsp-10mm	1	3.2
2430	assorted box plastic push in	1	3.5	2714	bulkhead 8mm mod pk10	1	3.7	2863	elbow swivel 1/2bsp-10mm	1	3.2
2431	straight conn 6mm-4mm pk10	10	3.7	2715	bulkhead 10mm mod pk10	10	3.7	2873	tee side swivel 1/4bsp-6mm	1	3.3
2432	straight conn 12mm-10mm pk10	10	3.7	2720	assort box metric plastic plugs	1	3.7	2874	tee side swivel 1/4bsp-6mm	1	3.3
2433	straight conn 8mm-6mm pk10	10	3.7	2724	plug 5/16od pk10	10	3.10	2875	tee side swivel 1/8bsp-8mm	1	3.3
2434	straight conn 10mm-6mm pk10	10	3.7	2727	pipe clip 15mm pk10	10	7.4	2885	tee swivel 1/8bsp-4mm	1	3.2
2435	straight conn 10mm-8mm pk10	10	3.7	2728	pipe clip 22mm pk10	10	7.4	2887	tee swivel 1/8bsp-5mm	1	3.2
2436	hoselet m16x1.5-3/8id t/o	1	3.9	2731	plug 4mm mod pk10	10	3.7	2889	tee swivel 1/8bsp-6mm	1	3.2
2448	tee conn 22mm-15mm pk2	2	3.7	2733	plug 6mm mod pk10	10	3.7	2890	tee swivel 1/4bsp-6mm	1	3.2
2451	tee conn 4mm pk10	10	3.6	2734	plug 8mm mod pk10	10	3.7	2891	tee swivel 1/8bsp-8mm	1	3.2
2452	tee conn 5mm pk10	10	3.6	2735	plug 10mm mod pk10	10	3.7	2892	tee swivel 1/4bsp-8mm	1	3.2
2453	tee conn 6mm pk10	10	3.6	2736	plug 12mm mod pk10	10	3.7	2894	tee swivel 1/4bsp-10mm	1	3.2
2454	tee conn 8mm pk10	10	3.6	2737	plug 15mm mod pk10	10	3.7	2901	straight conn 5/32	1	3.4
2455	tee conn 10mm pk10	10	3.6	2792	end stop 10mm	1	3.7	2902	straight conn 3/16	1	3.4
2456	tee conn 12mm pk10	10	3.6	2793	end stop 12mm	1	3.7	2903	straight conn 1/4	1	3.4
2457	tee conn 15mm pk10	10	3.6	2801	straight conn 4mm	1	3.2	2904	straight conn 5/16	1	3.4
2458	tee conn 18mm pk2	2	3.6	2802	straight conn 5mm	1	3.2	2905	straight conn 3/8	1	3.4
2459	tee conn 22mm pk2	2	3.6	2803	straight conn 6mm	1	3.2	2906	straight conn 1/2	1	3.4
2460	tee conn 28mm pk 2	1	3.6	2804	straight conn 8mm	1	3.2	2912	tee conn 3/16	1	3.4
2466	elbow conn 1/2 pk10	10	3.10	2805	straight conn 10mm	1	3.2	2913	tee conn 1/4	1	3.4
2472	elbow conn 5mm pk10	10	3.6	2806	straight conn 12mm	1	3.2	2921	elbow conn 5/32	1	3.4
2473	elbow conn 6mm pk10	10	3.6	2807	straight conn 14mm	1	3.2	2931	straight stud 1/8bsp-5/32	1	3.4
2474	elbow conn 8mm pk10	10	3.6	2808	stem y conn 8mm	1	3.7	2932	straight stud 1/8bsp-3/16	1	3.4
2475	elbow conn 10mm pk10	10	3.6	2809	stem y conn 10mm	1	3.7	2933	straight stud 1/8bsp-1/4	1	3.4
2476	elbow conn 12mm pk10	10	3.6	2810	tee conn 4mm	1	3.2	2934	straight stud 1/8bsp-5/16	1	3.4
2477	elbow conn 15mm pk10	10	3.6	2811	tee conn 5mm	1	3.2	2935	straight stud 1/4bsp-3/16	1	3.4
2478	elbow conn 18mm pk2	2	3.6	2812	tee conn 6mm	1	3.2	2936	straight stud 1/4bsp-1/4	1	3.4
2479	elbow conn 22mm pk2	2	3.6	2813	tee conn 8mm	1	3.2	2937	straight stud 1/4bsp-5/16	1	3.4
2480	elbow conn 28mm pk 2	2	3.6	2814	tee conn 10mm	1	3.2	2938	straight stud 1/4bsp-3/8	1	3.4
2487	stem reducer 15mm-12mm pk2	2	3.7	2819	y conn 10mm	1	3.5	2950	elbow swivel 1/8bsp-5/32	1	3.4
2490	assorted box plastic push in	1	3.8	2820	elbow conn 4mm	1	3.2	2951	elbow swivel 1/8bsp-3/16	1	3.4
2492	stem reducer 6mm-4mm pk10	10	3.7	2821	elbow conn 5mm	1	3.2	2951NPT	elbow swivel 1/8npt-3/16	1	3.4
2493	stem reducer 6mm-5mm pk10	10	3.7	2822	elbow conn 6mm	1	3.2	2952	elbow swivel 1/8bsp-1/4	1	3.4
2495	stem reducer 8mm-6mm pk10	10	3.7	2823	elbow conn 8mm	1	3.2	2953	elbow swivel 1/8bsp-5/16	1	3.4
2497	stem reducer 10mm-8mm pk10	10	3.7	2824	elbow conn 10mm	1	3.2	2954	elbow swivel 1/4bsp-3/16	1	3.4
2498	stem reducer 12mm-8mm pk10	10	3.7	2825	bulkhead 4mm	1	3.3	2954NPT	elbow swivel 1/4npt-3/16	1	3.4
2499	stem reducer 12mm-10mm pk10	10	3.7	2827	bulkhead 6mm	1	3.3	2955	elbow swivel 1/4bsp-1/4	1	3.4
2523	stem stud 1/8bsp-5mm pk10	10	3.6	2828	bulkhead 8mm	1	3.3	2956	elbow swivel 1/4bsp-5/16	1	3.4
2526	stem stud 1/4bsp-6mm pk10	10	3.6	2829	bulkhead 10mm	1	3.3	2957	elbow swivel 1/4bsp-3/8	1	3.4
2528	stem stud 1/4bsp-8mm pk10	10	3.6	2830	straight stud 1/8bsp-4mm	1	3.2	2958	elbow swivel 3/8bsp-3/8	1	3.4
2530	stem stud 1/4bsp-10mm pk10	10	3.6	2831	straight stud 1/4bsp-4mm	1	3.2	2960	elbow swivel 1/2bsp-3/8	1	3.4
2541	stem elbow 4mm pk2	2	3.6	2832	straight stud 1/8bsp-5mm	1	3.2	2988	tee swivel 3/8bsp-3/8	1	3.4
2543	stem elbow 6mm pk2	2	3.6	2833	straight stud 1/4bsp-5mm	1	3.2	2990	stem reducer 6mm-4mm	1	3.3
2544	stem elbow 8mm pk2	2	3.6	2834	straight stud 1/8bsp-6mm	1	3.2	2991	stem reducer 8mm-4mm	1	3.3
2545	stem elbow 10mm pk2	2	3.6	2835	straight stud 1/4bsp-6mm	1	3.2	2992	stem reducer 10mm-4mm	1	3.3
2546	stem elbow 12mm pk2	2	3.6	2836	straight stud 1/8bsp-8mm	1	3.2	2993	stem reducer 8mm-6mm	1	3.3
2583	straight stud 1/8bsp-3/16 pk10	10	3.10	2837	straight stud 1/4bsp-8mm	1	3.2	2994	stem reducer 10mm-6mm	1	3.3
2584	straight stud 1/8bsp-1/4 pk10	10	3.10	2838	straight stud 3/8bsp-8mm	1	3.2	2995	stem reducer 10mm-8mm	1	3.3
2585	straight stud 1/4bsp-1/4 pk10	10	3.10	2839	straight stud 1/2bsp-8mm	1	3.2	2996	stem reducer 12mm-8mm	1	3.3
2590	straight stud 3/8bsp-3/8 pk10	10	3.10	2840	straight stud 1/8bsp-10mm	1	3.2	2997	stem reducer 12mm-10mm	1	3.3
2591	straight stud 3/8bsp-1/2 pk10	10	3.10	2841	straight stud 1/4bsp-10mm	1	3.2	3000	assorted box stepped olives	1	4.4
2594	straight stud 3/4bspt-22mm brass	1	3.9	2842	straight stud 3/8bsp-10mm	1	3.2	3001	stepped olive 1/8 pkt 25	25	4.4
2597	elbow wingback 3/4bsp-22mm	1	3.9	2843	straight stud 1/2bsp-10mm	1	3.2	3003	stepped olive 3/16 pkt25	25	4.4
2601	straight stud 1/8bsp-4mm pk10	10	3.6	2844	straight stud connector	1	3.2	3004	stepped olive 1/4 pkt20	20	4.4
2606	straight stud 1/4bsp-6mm pk10	10	3.6	2849	elbow swivel 1/8bsp-4mm	1	3.2	3005	stepped olive 5/16 pkt15	15	4.4
2608	straight stud 1/4bsp-8mm pk10	10	3.6	2850	elbow swivel 1/4bsp-4mm	1	3.2	3006	stepped olive 3/8 pkt12	12	4.4

Part No.	Description	Qty	Page	Part No.	Description	Qty	Page	Part No.	Description	Qty	Page
3007	stepped olive 1/2 pkt8	8	4.4	3255	straight conn 5/16 pkt3	3	4.5	4430	tee conn 1/4	1	3.9
3008	stepped olive 5/8 pkt5	5	4.4	3266	straight conn 3/8 pkt2	2	4.5	4432	tee conn 3/8	1	3.9
3010	assorted box imperial barrel olives	1	4.4	3277	straight conn 1/2 pkt1	1	4.5	4433	tee conn 1/2	1	3.9
3011	barrel olive 1/8 pkt25	25	4.4	3300	assorted box metric straight	1	4.2	4437	elbow conn 1/4	1	3.9
3012	barrel olive 5/32 pkt25	25	4.4	3305	straight conn 5mm pkt3	3	4.2	4439	elbow conn 3/8	1	3.9
3013	barrel olive 3/16 pkt25	25	4.4	3309	straight conn 9mm pkt2	2	4.2	4440	elbow conn 1/2	1	3.9
3014	barrel olive 1/4 pkt20	20	4.4	3311	straight conn 4mm pkt3	3	4.2	4441	straight stud 1/8bspt-4mm	1	3.5
3015	barrel olive 5/16 pkt15	15	4.4	3322	straight conn 6mm pkt3	3	4.2	4442	straight stud 1/8bspt-6mm	1	3.5
3016	barrel olive 3/8 pkt12	12	4.4	3323	straight conn 6mm-8mm pkt2	2	4.2	4443	straight stud 1/4bspt-6mm	1	3.5
3017	barrel olive 1/2 pkt8	8	4.4	3333	straight conn 8mm pkt3	3	4.2	4444	straight stud 1/4bspt-10mm	1	3.5
3020	metric stepped olives	1	4.2	3334	straight conn 8mm-10mm pkt1	1	4.2	4445	straight stud 3/8bspt-10mm	1	3.5
3021	stepped olive 4mm pkt25	25	4.2	3344	straight conn 10mm pkt2	2	4.2	4446	straight stud 1/2bspt-10mm	1	3.5
3022	stepped olive 6mm pkt20	20	4.2	3345	straight conn 10mm-12mm	1	4.2	4447	straight stud 3/8bsp-12mm	1	3.5
3023	stepped olive 8mm pkt15	15	4.2	3355	straight conn 12mm pkt 2	2	4.2	4448	straight stud 1/2bspt-12mm	1	3.5
3024	stepped olive 10mm pkt12	12	4.2	3366	straight conn 13mm pkt1	1	4.2	4449	straight stud 1/8bspt-8mm	1	3.5
3025	stepped olive 12mm pkt8	8	4.2	3377	straight conn 14mm pkt1	1	4.2	4450	straight stud 1/4bspt-8mm	1	3.5
3027	stepped olive 14mm pkt6	6	4.2	3388	straight conn 15mm pkt1	1	4.2	4451	tee conn 4mm	1	3.5
3028	stepped olive 15mm pkt6	6	4.2	3399	straight conn 16mm pkt1	1	4.2	4452	tee conn 5mm	1	3.5
3029	stepped olive 16mm pkt5	5	4.2	3522	tee conn 6mm pkt1	1	4.3	4453	tee conn 6mm	1	3.5
3030	assorted box metric barrel olives	1	4.2	3533	tee conn 8mm pkt1	1	4.3	4454	tee conn 8mm	1	3.5
3031	barrel olive 4mm pkt25	25	4.2	3544	tee conn 10mm pkt1	1	4.3	4455	tee conn 10mm	1	3.5
3032	barrel olive 6mm pkt 20	20	4.2	3733	elbow conn 8mm pkt 1	1	4.3	4456	tee conn 12mm	1	3.5
3033	barrel olive 8mm pkt15	15	4.2	3813	straight stud 1/8bsp-3/16 pkt4	4	4.5	4458	tee conn 16mm	1	3.5
3034	barrel olive 10mm pkt12	12	4.2	3844	straight stud 1/4bsp-1/4 pkt3	3	4.5	4459	straight stud 1/4bspp-8mm	1	3.5
3035	barrel olive 12mm pkt8	8	4.2	3845	straight stud 1/4bsp-5/16 pkt3	3	4.5	4461	elbow swivel 1/8bspt-4mm	1	3.5
3036	barrel olive 13mm pkt8	8	4.2	3847	straight stud 1/4bsp-1/2 pkt1	1	4.5	4462	elbow swivel 1/8bspt-6mm	1	3.5
3038	barrel olive 15mm pkt6	6	4.2	3866	straight stud 3/8bsp-3/8 pkt2	2	4.5	4463	elbow swivel 1/4bspt-6mm	1	3.5
3039	barrel olive 16mm pkt5	5	4.2	3876	straight stud 1/2bsp-3/8 pkt1	1	4.5	4464	elbow swivel 1/4bspt-10mm	1	3.5
3095	stepped olive 5mm pkt20	20	4.2	3877	straight stud 1/2bsp-1/2 pkt1	1	4.5	4465	elbow swivel 3/8bspt-10mm	1	3.5
3099	stepped olive 9mm pkt12	12	4.2	3912	straight stud 1/8bsp-6mm pkt3	3	4.3	4466	elbow swivel 1/2bspt-10mm	1	3.5
3100	assorted box tube supports	1	2.5	3913	straight stud 1/8bsp-8mm pkt3	3	4.3	4467	elbow swivel 3/8bspt-12mm	1	3.5
3100	assorted box tube supports	1	4.2	3942	straight stud 1/4bsp-6mm pkt3	3	4.3	4468	elbow swivel 1/2bspt-12mm	1	3.5
3151	tube support 4mm pkt10	10	2.5	3943	straight stud 1/4bsp-8mm pkt3	3	4.3	4469	elbow swivel 1/8bspt-8mm	1	3.5
3151	tube support 4mm pkt10	10	4.2	3944	straight stud 1/4bsp-10mm pkt2	2	4.3	4470	elbow swivel 1/4bspt-8mm	1	3.5
3152	tube support 6mm pkt10	10	2.5	3945	straight stud 1/4bsp-12mm pkt1	1	4.3	4471	elbow conn 4mm	1	3.5
3152	tube support 6mm pkt10	10	2.5	4013	elbow stud 1/8bsp-3/16 pkt2	2	4.5	4473	elbow conn 6mm	1	3.5
3152	tube support 6mm pkt10	10	4.2	4045	elbow stud 1/4bsp-5/16 pkt2	2	4.5	4474	elbow conn 8mm	1	3.5
3152	tube support 6mm pkt10	10	4.2	4046	elbow stud 1/4bsp-3/8 pkt1	1	4.5	4475	elbow conn 10mm	1	3.5
3153	tube support 7mm pkt10	10	2.5	4144	elbow stud 1/4bsp-10mm pkt1	1	4.3	4476	elbow conn 12mm	1	3.5
3153	tube support 7mm pkt10	10	4.2	4214	reducing bush 1/4x1/8 pkt4	4	2.7	4478	elbow conn 16mm	1	3.5
3154	tube support 8mm pkt10	10	2.5	4214	reducing bush 1/4x1/8 pkt4	4	4.5	4481	y conn 6mm	1	3.5
3154	tube support 8mm pkt10	10	2.5	4246	reducing bush 3/8x1/4 pkt4	4	2.7	4482	y conn 8mm	1	3.5
3154	tube support 8mm pkt10	10	4.2	4246	reducing bush 3/8x1/4 pkt4	4	4.5	4494	bulkhead m22-m16-m10x1fem	1	1.10
3154	tube support 8mm pkt10	10	4.2	4247	reducing bush 1/2x1/4 pkt3	3	2.7	4497	elbow 45deg m/f m16x1.5 no l/n	1	1.12
3155	tube support 9mm pkt10	10	2.5	4247	reducing bush 1/2x1/4 pkt3	3	4.5	4498	elbow 45deg male/fem m22 x 1.5	1	1.12
3155	tube support 9mm pkt10	10	2.5	4267	reducing bush 1/2x3/8 pkt3	3	2.7	4499	bulkhead m22-m16 f c/w locknut	1	1.10
3155	tube support 9mm pkt10	10	4.2	4267	reducing bush 1/2x3/8 pkt3	3	4.5	4566C	straight coupling 6x1	1	1.8
3155	tube support 9mm pkt10	10	4.2	4279	reducing bush 3/4x1/2 pkt2	2	2.7	4567C	straight coupling 8x1	1	1.8
3156	tube support 10mm pkt10	10	2.5	4279	reducing bush 3/4x1/2 pkt2	2	4.5	4568C	straight coupling 10x1	1	1.8
3156	tube support 10mm pkt10	10	4.2	4404	plug 1/4bsp pkt4	4	4.5	4569C	straight coupling 10x1.25	1	1.8
3157	tube support 11mm pkt10	10	2.5	4406	plug 3/8bsp pkt4	4	4.5	4570C	straight coupling 10x1.5	1	1.8
3157	tube support 11mm pkt10	10	4.2	4407	plug 1/2bsp pkt3	3	4.5	4571C	straight coupling 12x1.5	1	1.8
3158	tube support 12mm pkt6	6	2.5	4410	straight conn 4mm	1	3.5	4572C	straight coupling 15x1.5	1	1.8
3158	tube support 12mm pkt6	6	2.5	4411	straight conn 5mm	1	3.5	4581	elbow female m12x1.5	1	1.11
3158	tube support 12mm pkt6	6	4.2	4412	straight conn 6mm	1	3.5	4582	elbow female m16x1.5	1	1.11
3158	tube support 12mm pkt6	6	4.2	4413	straight conn 8mm	1	3.5	4583	elbow female m22x1.5	1	1.11
3159	tube support 14mm pkt10	10	2.5	4415	straight conn 10mm	1	3.5	4584	elbow male/female m12x1.5	1	1.11
3159	tube support 14mm pkt10	10	4.2	4416	straight conn 12mm	1	3.5	4585	elbow male/female m16x1.5	1	1.11
3160	tube support 7.5mm pkt10	10	2.5	4419	straight conn 16mm	1	3.5	4586	elbow m/f m22x1.5m-m16x1.5f	1	1.11
3160	tube support 7.5mm pkt10	10	4.2	4421	straight conn 5/32	1	3.9	4587	elbow m/f m16x1.5 c/w l/n+o/r	1	1.11
3162	tube support 1/2 x.375 pkt8	8	4.4	4422	straight conn 3/16	1	3.9	4588	elbow m16x1.5f-m22x1.5m	1	1.11
3164	tube support 5/16x.212 pkt10	10	4.4	4423	straight conn 1/4	1	3.9	4593	tee female m12x1.5	1	1.11
3200	assorted box imperial straight	1	4.5	4424	straight conn 5/16	1	3.9	4594	tee female m16x1.5	1	1.11
3211	straight conn 1/8 pkt3	3	4.5	4425	straight conn 3/8	1	3.9	4595	tee female m22x1.5	1	1.11
3222	straight conn 5/32 pkt3	3	4.5	4426	straight conn 1/2	1	3.9	4596	tee female m16x1.5 c/w bracket	1	1.11
3233	straight conn 3/16 pkt4	4	4.5	4428	tee conn 5/32	1	3.9	4604	adaptor m/f m16x1.5-m12x1.5	1	2.7
3244	straight conn 1/4 pkt3	3	4.5	4429	tee conn 3/16	1	3.9	4606	adaptor m/f m22x1.5-m16x1.5	1	2.7

Part No.	Description	Qty	Page	Part No.	Description	Qty	Page	Part No.	Description	Qty	Page
4607	adaptor male/m16x1.5-1/8nptf	1	2.7	4758	straight conn ng12-12x1.5mm 232	1	1.38	5104	tube nut 1/4	1	4.4
4608	adaptor male/fem m16x1.5-1/4nptf	1	2.7	4759	male nut ng8 232	1	1.38	5123	tube nut 8mm	1	4.2
4609	adaptor male/femm16x1.5-3/8nptf	1	2.7	4760	male nut ng12 232	1	1.38	5125	tube nut 12mm	1	4.2
4610	adaptor male/fem 1/4npt-m12x1.5	1	2.7	4761	elbow ng8-6x1mm 232	1	1.38	5151	tube support 4mm	1	2.5
4611	adaptor male/fem 1/4npt-m16x1.5	1	2.7	4762	elbow ng8-8x1mm 232	1	1.38	5151	tube support 4mm	1	4.2
4612	adaptor male/fem 3/8npt-m16x1.5	1	2.7	4763	elbow ng12-6x1mm 232	1	1.38	5152	tube support 6mm	1	2.5
4613	bulkhead conn m16x1.5 - m18x1.5	1	1.10	4764	elbow ng12-8x1mm 232	1	1.38	5152	tube support 6mm	1	2.5
4628	locknut m22x1.5 raufoss	1	1.10	4765	elbow ng12-12x1.5mm 232	1	1.38	5152	tube support 6mm	1	4.2
4630	bulkhead male/fem m22-m16	1	1.10	4766	elbow ng12-16x2mm 232	1	1.38	5152	tube support 6mm	1	4.2
4631	bulkhead m16-m16-m22 c/w o-ring	1	1.10	4768	adaptor ng8-m16 x1.5 232	1	1.38	5153	tube support 7mm	1	2.5
4632	bulkhead conn m16x1.5	1	1.10	4769	adaptor ng12-m16 x1.5 232	1	1.38	5153	tube support 7mm	1	4.2
4633R	adaptor m16-m18 (24deg cone)	1	1.10	4770	adaptor ng12-m22x1.5 232	1	1.38	5154	tube support 8mm	1	2.5
4635	male brass adaptor m10 x 1	1	2.6	4771	tee ng12-12 x1.5mm 232	1	1.37	5154	tube support 8mm	1	2.5
4639R	locknut m14x1.5 c/w oring	1	1.10	4772	straight conn 8x1mm-ng8 230	1	1.34	5154	tube support 8mm	1	4.2
4640	locknut m12x1.5 c/w oring	1	1.10	4776	tee ng12-12x1.5mm 230	1	1.34	5154	tube support 8mm	1	4.2
4641	locknut m16x1.5 c/w oring	1	1.10	4778	assembly unit m10x1-6x1mm 230	1	1.34	5155	tube support 9mm	1	2.5
4642	locknut m22x1.5 c/w oring	1	1.10	4780	straight conn 8x1mm-ng8 232	1	1.37	5155	tube support 9mm	1	2.5
4643	tee branch stud m16x1.5 no l/nut	1	1.11	4939	voss manifold	1	1.36	5155	tube support 9mm	1	4.2
4645	female socket m16x1.5	1	1.12	4940	voss manifold	1	1.36	5155	tube support 9mm	1	4.2
4646	female socket m22x1.5	1	1.12	4941	voss manifold	1	1.36	5156	tube support 10mm	1	2.5
4651	side stud tee m16 x 1.5	1	1.11	4942	voss manifold	1	1.36	5156	tube support 10mm	1	4.2
4652	side stud tee m16 x m22	1	1.11	4992	voss 230 & 232 assembly tool	1	1.35	5157	tube support 11m	1	2.5
4661	side stud tee m16 x 1.5	1	1.11	4992	voss 230 & 232 assembly tool	1	1.37	5157	tube support 11m	1	4.2
4662	tube release tool 6x1mm	1	1.4	5001	stepped olive 1/8	1	4.4	5158	tube support 12mm	1	2.5
4663	tube release tool 8x1mm	1	1.4	5002	stepped olive 5/32	1	4.4	5158	tube support 12mm	1	2.5
4664	tube release tool 10x1mm	1	1.4	5003	stepped olive 3/16	1	4.4	5158	tube support 12mm	1	4.2
4665	tube release tool 12x1.5mm	1	1.4	5004	stepped olive 1/4	1	4.4	5158	tube support 12mm	1	4.2
4666	tube release tool 15x1.5mm	1	1.4	5005	stepped olive5/16	1	4.4	5159	tube support 14mm	1	2.5
4667	tube release tool 16x2mm	1	1.4	5006	stepped olive 3/8	1	4.4	5159	tube support 14mm	1	4.2
4668A	assorted box tube release tools	1	1.4	5007	stepped olive 1/2	1	4.4	5160	tube support 7.5mm	1	2.5
4670	elbow male/fem m22x1.5-m16 c/w l/n	1	1.11	5008	stepped olive 5/8	1	4.4	5160	tube support 7.5mm	1	4.2
4700	clip ng8 230	1	1.35	5011	barrel olive 1/8	1	4.4	5162	tube support 1/2x.375	1	4.4
4701	clip ng12 230	1	1.35	5012	barrel olive 5/32	1	4.4	5164	tube support 5/16x.212	1	4.4
4702	male nut ng8 230	1	1.35	5013	barrel olive 3/16	1	4.4	5211	straight conn 1/8	1	4.5
4703	male nut ng12 230	1	1.35	5014	barrel olive 1/4	1	4.4	5222	straight conn 5/32	1	4.5
4704	spring element ng8	1	1.35	5015	barrel olive 5/16	1	4.4	5233	straight conn 3/16	1	4.5
4705	spring element ng12	1	1.35	5016	barrel olive 3/8	1	4.4	5234	straight conn 3/16x1/4	1	4.5
4706	adaptor ng8-m16x1.5 230	1	1.34	5017	barrel olive 1/2	1	4.4	5235	straight conn 3/16x5/16	1	4.5
4712	adaptor ng12-m16x1.5 230	1	1.34	5018	barrel olive 5/8	1	4.4	5244	straight conn 1/4	1	4.5
4714	adaptor ng12-m22x1.5 230	1	1.34	5019	barrel olive 3/4	1	4.4	5246	straight conn 1/4x3/8	1	4.5
4715	plug m16x1.5 c/w t&o	1	1.12	5021	stepped olive 4mm	1	4.2	5247	straight conn 1/4x1/2	1	4.5
4716	plug m22x1.5 c/w t&o	1	1.12	5022	stepped olive 6mm	1	4.2	5255	straight conn 5/16	1	4.5
4717	plug m12x1.5 c/w t&o	1	1.12	5023	stepped olive 8mm	1	4.2	5256	straight conn 5/16x3/8	1	4.5
4720	repair kit ng8 230	1	1.35	5024	stepped olive 10mm	1	4.2	5257	straight conn 5/16x1/2	1	4.5
4721	repair kit ng12 230	1	1.35	5025	stepped olive 12mm	1	4.2	5266	straight conn 3/8	1	4.5
4725	air seal ng8 232 7x1.5 o-ring	1	1.37	5026	stepped olive 13mm	1	4.2	5277	straight conn 1/2	1	4.5
4726	air seal ng12 232 12x1.6 o-ring	1	1.37	5027	stepped olive 14mm	1	4.2	5288	straight conn 5/8	1	4.5
4727	nitrile o ring 1/2 x 3/4	1	2.4	5028	stepped olive 15mm	1	4.2	5301	straight conn 11mm	1	4.2
4730	dirt seal ng8 232 7.5x2 o-ring	1	1.37	5029	stepped olive 16mm	1	4.2	5305	straight conn 5mm	1	4.2
4731	dirt seal ng12 232 12x2 o-ring	1	1.37	5031	barrel olive	1	4.2	5309	straight conn 9mm	1	4.2
4734	plug 8mm od	1	3.7	5032	barrel olive	1	4.2	5311	straight conn 4mm	1	4.2
4740	straight conn ng8-6x1mm 230	1	1.35	5033	barrel olive	1	4.2	5322	straight conn 6mm	1	4.2
4741	straight conn ng8-8x1mm 230	1	1.35	5034	barrel olive	1	4.2	5323	straight conn 6mmx8mm	1	4.2
4742	straight conn ng12-6x1mm 230	1	1.35	5035	barrel olive	1	4.2	5333	straight conn 8mm	1	4.2
4743	straight conn ng12-8x1mm 230	1	1.35	5036	barrel olive	1	4.2	5334	straight conn 8mmx10mm	1	4.2
4744	straight conn ng12-12x1.5mm 230	1	1.35	5037	barrel olive	1	4.2	5344	straight conn 10mm	1	4.2
4746	elbow ng8-6x1mm 230	1	1.35	5038	barrel olive	1	4.2	5345	straight conn 10mmx12mm	1	4.2
4747	elbow ng8-8x1mm 230	1	1.35	5039	barrel olive	1	4.2	5355	straight conn 12mm	1	4.2
4748	elbow ng12-6x1mm 230	1	1.35	5046	wade ferrule 3/8	1	4.4	5366	straight conn 13mm	1	4.2
4749	elbow ng12-8x1mm 230	1	1.35	5050	wade ferrule 6mm	1	4.2	5377	straight conn 14mm	1	4.2
4750	elbow ng12-12x1.5 230	1	1.35	5051	wade ferrule 8mm	1	4.2	5388	straight conn 15mm	1	4.2
4751	elbow ng12-16x2mm 230	1	1.35	5052	wade ferrule 10mm	1	4.2	5399	straight conn 16mm	1	4.2
4753	tee ng12-12x 1.5mm 230	1	1.34	5053	wade ferrule 12mm	1	4.2	5411	tee conn 1/8	1	4.4
4754	straight conn ng8-6x1mm 232	1	1.38	5091	stepped olive 11mm	1	4.2	5422	tee conn 5/32	1	4.4
4755	straight conn ng8-8x1mm 232	1	1.38	5095	stepped olive 5mm	1	4.2	5433	tee conn 3/16	1	4.4
4756	straight conn ng12-6x1mm 232	1	1.38	5099	stepped olive 9mm	1	4.2	5444	tee conn 1/4	1	4.4
4757	straight conn ng12-8x1mm 232	1	1.38	5103	tube nut 3/16	1	4.4	5455	tee conn 5/16	1	4.4

Part No.	Description	Qty	Page	Part No.	Description	Qty	Page	Part No.	Description	Qty	Page
5466	tee conn 3/8	1	4.4	6175	elbow stud 1/2bsp-12mm	1	4.3	6573	straight stud m22x1.5-8mm p/i	1	1.30
5477	tee conn 1/2	1	4.4	6178	elbow stud 1/2bsp-15mm	1	4.3	6576	straight stud m10x1-10mm p/i	1	1.30
5505	tee conn 5mm	1	4.3	6214	reducing bush 1/4-1/8	1	2.7	6577	straight stud m12x1.5-10mm p/i	1	1.30
5509	tee conn 9mm	1	4.3	6214	reducing bush 1/4-1/8	1	4.5	6578	straight stud m14x1.5-10mm p/i	1	1.30
5511	tee conn 4mm	1	4.3	6215	reducing bush 1/4bsp-1/8spm	1	4.6	6579	straight stud m16x1.5-10mm p/i	1	1.30
5522	tee conn 6mm	1	4.3	6246	reducing bush 3/8-1/4	1	2.7	6580	straight stud m22x1.5-10mm p/i	1	1.30
5533	tee conn 8mm	1	4.3	6246	reducing bush 3/8-1/4	1	4.5	6584	straight stud m12x1.5-12mm p/i	1	1.30
5544	tee conn 10mm	1	4.3	6247	reducing bush 1/2-1/4	1	2.7	6585	straight stud m14x1.5-12mm p/i	1	1.30
5555	tee conn 12mm	1	4.3	6247	reducing bush 1/2-1/4	1	4.5	6586	straight stud m16x1.5-12mm p/i	1	1.30
5611	elbow conn 1/8	1	4.5	6267	reducing bush 1/2-3/8	1	2.7	6587	straight stud m22x1.5-12mm p/i	1	1.30
5633	elbow conn 3/16	1	4.5	6267	reducing bush 1/2-3/8	1	4.5	6594	straight stud m22x1.5-15mm p/i	1	1.30
5644	elbow conn 1/4	1	4.5	6279	reducing bush 3/4-1/2	1	2.7	6595	straight stud m16x1.5-16mm p/i	1	1.30
5655	elbow conn 3/16	1	4.5	6279	reducing bush 3/4-1/2	1	4.5	6596	straight stud m22x1.5-16mm p/i	1	1.30
5666	elbow conn 3/8	1	4.5	6345	straight stud fem 1/4bsp-5/16	1	4.6	6600A	assorted box brass push in	1	1.31
5677	elbow conn 1/2	1	4.5	6401	plug 1/8bsp	1	4.5	6601	elbow stud m10x1-10mm p/i	1	1.30
5688	elbow conn 5/8	1	4.5	6404	plug 1/4bsp	1	4.5	6602	elbow stud m12x1.5-6mm p/i	1	1.30
5709	elbow conn 9mm	1	4.3	6406	plug 3/8bsp	1	4.5	6603	elbow swivel m16x1.5-6mm p/i	1	1.31
5722	elbow conn 6mm	1	4.3	6407	plug 1/2bsp	1	4.5	6604	elbow stud m12x1.5-8mm p/i	1	1.30
5733	elbow conn 8mm	1	4.3	6408	plug 6mm (acetal)	1	3.7	6605	elbow stud m16x1.5-8mm p/i	1	1.30
5744	elbow conn 10mm	1	4.3	6409	plug 8mm (acetal)	1	3.7	6606	elbow stud m22x1.5-8mm p/i	1	1.30
5755	elbow conn 12mm	1	4.3	6410	plug 10mm (acetal)	1	3.7	6607	elbow stud m14x1.5-8mm p/i	1	1.30
5811	straight stud 1/8bsp-1/8	1	4.5	6500A	assorted box brass push in	1	1.31	6608	elbow stud m14x1.5-10mm p/i	1	1.30
5813	straight stud 1/8bsp-3/16	1	4.5	6500M	assorted box brass push in	1	1.31	6609	elbow stud m22x1.5-6mm p/i	1	1.30
5814	straight stud 1/8bsp-1/4	1	4.5	6500P	assorted box norgren brass	1	1.31	6610	elbow stud m12x1.5-10mm p/i	1	1.30
5815	straight stud 1/8bsp-5/16	1	4.5	6502	straight conn 6mm p/i	1	1.29	6611	elbow swivel m16x1.5-8mm p/i	1	1.31
5843	straight stud 1/4bsp-3/16	1	4.5	6504	straight conn 8mm p/i	1	1.29	6613	elbow stud m16x1.5-10mm p/i	1	1.30
5844	straight stud 1/4bsp-1/4	1	4.5	6505	straight conn 9mm p/i	1	1.29	6614	elbow stud m22x1.5-10mm p/i	1	1.30
5845	straight stud 1/4bsp-5/16	1	4.5	6506	straight conn 10mm p/i	1	1.29	6619	elbow stud m16x1.5-12mm p/i	1	1.30
5846	straight stud 1/4bsp-3/8	1	4.5	6507	straight conn 11mm p/i	1	1.29	6620	elbow stud m22x1.5-12mm p/i	1	1.30
5847	straight stud 1/4bsp-1/2	1	4.5	6508	straight conn 12mm p/i	1	1.29	6625	elbow stud m16x1.5-16mm p/i	1	1.30
5864	straight stud 3/8bsp-1/4	1	4.5	6510	straight conn 14mm p/i	1	1.29	6626	elbow stud m22x1.5-16mm p/i	1	1.30
5866	straight stud 3/8bsp-3/8	1	4.5	6511	straight conn 15mm p/i	1	1.29	6638	tee stud m16x1.5-10mm p/i	1	1.29
5876	straight stud 1/2bsp-3/8	1	4.5	6512	straight conn 16mm p/i	1	1.29	6639	tee stud m22x1.5-10mm p/i	1	1.29
5877	straight stud 1/2bsp-1/2	1	4.5	6513	straight unequal 8mm-6mm p/i	1	1.29	6644	tee stud m16x1.5-12mm p/i	1	1.29
5878	straight stud 1/2bsp-5/8	1	4.5	6514	straight unequal 10mm-6mm p/i	1	1.29	6645	tee stud m22x1.5-12mm p/i	1	1.29
5911	straight stud 1/8bsp-4mm	1	4.3	6515	straight unequal 10mm-8mm p/i	1	1.29	6650	elbow stud 45deg m16x1.5-12mm	1	1.30
5912	straight stud 1/8bsp-6mm	1	4.3	6517	tee conn 6mm p/i	1	1.29	6665	straight conn 1/4 p/i	1	1.32
5913	straight stud 1/8bsp-8mm	1	4.3	6518	straight unequal 12mm-10mm p/i	1	1.29	6667	straight conn 3/8 p/i	1	1.32
5942	straight stud 1/4bsp-6mm	1	4.3	6519	tee conn 8mm p/i	1	1.29	6668	straight conn 1/2 p/i	1	1.32
5943	straight stud 1/4bsp-8mm	1	4.3	6520	tee conn 9mm p/i	1	1.29	6669	straight conn 5/8 p/i	1	1.32
5944	straight stud 1/4bsp-10mm	1	4.3	6521	tee conn 10mm p/i	1	1.29	6675	tee conn 1/4 p/i	1	1.32
5945	straight stud 1/4bsp-12mm	1	4.3	6522	tee conn 11mm p/i	1	1.29	6677	tee conn 3/8 p/i	1	1.32
5964	straight stud 3/8bsp-10mm	1	4.3	6523	tee conn 12mm p/i	1	1.29	6678	tee conn 1/2 p/i	1	1.32
5965	straight stud 3/8bsp-12mm	1	4.3	6524	tee conn 12mm-10mm p/i	1	1.29	6684	elbow conn 1/4 p/i	1	1.32
5974	straight stud 1/2bsp-10mm	1	4.3	6526	tee conn 15mm p/i	1	1.29	6686	elbow conn 3/8 p/i	1	1.32
5978	straight stud 1/2bsp-15mm	1	4.3	6527	tee conn 16mm p/i	1	1.29	6687	elbow conn 1/2 p/i	1	1.32
5979	straight stud 1/2bsp-16mm	1	4.3	6528	tee conn 10mm-6mm p/i	1	1.29	6694	bulkhead conn 3/8 p/i	1	1.33
6012	elbow stud 1/8bsp-5/32	1	4.5	6530	tee conn 12mm-6mm p/i	1	1.29	6695	bulkhead conn 1/2 p/i	1	1.33
6013	elbow stud 1/8bsp-3/16	1	4.5	6533	elbow conn 6mm p/i	1	1.29	6701	straight stud 1/8bsp-1/4 p/i	1	1.32
6014	elbow stud 1/8bsp-1/4	1	4.5	6535	elbow conn 8mm p/i	1	1.29	6703	elbow stud m16x1.5-6mm p/i	1	1.30
6015	elbow stud 1/8bsp-5/16	1	4.5	6537	elbow conn 10mm p/i	1	1.29	6705	straight stud 1/4bsp-1/4 p/i	1	1.32
6044	elbow stud 1/4bsp-1/4	1	4.5	6539	elbow conn 12mm p/i	1	1.29	6706	straight stud 1/8bsp-3/8 p/i	1	1.32
6045	elbow stud 1/4bsp-5/16	1	4.5	6542	elbow conn 15mm p/i	1	1.29	6707	straight stud 1/4bsp-3/8 p/i	1	1.32
6046	elbow stud 1/4bsp-3/8	1	4.5	6543	elbow conn 16mm p/i	1	1.29	6708	straight stud 1/4bsp-1/2 p/i	1	1.32
6047	elbow stud 1/4bsp-1/2	1	4.5	6549	bulkhead conn 6mm p/i	1	1.31	6711	elbow stud 45 deg m16x1.5-10mm	1	1.30
6066	elbow stud 3/8bsp-3/8	1	4.5	6551	bulkhead conn 8mm p/i	1	1.31	6712	straight stud 3/8bsp-3/8 p/i	1	1.32
6067	elbow stud 3/8bsp-1/2	1	4.5	6553	bulkhead conn 10mm p/i	1	1.31	6713	straight stud 3/8bsp-1/2 p/i	1	1.32
6076	elbow stud 1/2bsp-3/8	1	4.5	6555	bulkhead conn 12mm p/i	1	1.31	6714	straight stud 1/2bsp-3/8 p/i	1	1.32
6077	elbow stud 1/2bsp-1/2	1	4.5	6564	straight stud m10x1-6mm p/i	1	1.30	6715	straight stud 1/2bsp-1/2 p/i	1	1.32
6078	elbow stud 1/2bsp-5/8	1	4.5	6565	straight stud m12x1.5-6mm p/i	1	1.30	6720	elbow stud 1/8bsp-1/4 p/i	1	1.32
6111	elbow stud 1/8bsp-4mm	1	4.3	6566	straight stud m14x1.5-6mm p/i	1	1.30	6720NPT	elbow stud 1/8npt -1/4 p/i	1	1.32
6112	elbow stud 1/8bsp-6mm	1	4.3	6567	straight stud m16x1.5-6mm p/i	1	1.30	6720NPT	elbow stud 1/8npt -1/4 p/i	1	1.32
6142	elbow stud 1/4bsp-6mm	1	4.3	6568	straight stud m22x1.5-6mm p/i	1	1.30	6723	elbow stud 1/4bsp-1/4 p/i	1	1.32
6143	elbow stud 1/4bsp-8mm	1	4.3	6569	straight stud m10x1.5-8mm p/i	1	1.30	6723NPT	elbow stud 1/4 npt-1/4 p/i	1	1.32
6144	elbow stud 1/4bsp-10mm	1	4.3	6570	straight stud m12x1.5-8mm p/i	1	1.30	6723NPT	elbow stud 1/4 npt-1/4 p/i	1	1.32
6145	elbow stud 1/4bsp-12mm	1	4.3	6571	straight stud m14x1.5-8mm p/i	1	1.30	6726	elbow stud 1/4bsp-3/8 p/i	1	1.32
6174	elbow stud 1/2bsp-10mm	1	4.3	6572	straight stud m16x1.5-8mm p/i	1	1.30	6726NPT	elbow stud 1/4 npt-3/8 p/i	1	1.32

Part No.	Description	Qty	Page	Part No.	Description	Qty	Page	Part No.	Description	Qty	Page
6726NPT	elbow stud 1/4 npt-3/8 p/i	1	1.32	6807NPT	stud elbow 1/2npt-12mm p/i	1	1.31	6965	adblue automatic st/steel nozzle	1	8.9
6727	elbow stud 1/4bsp-1/2 p/i	1	1.32	6809NPT	stud elbow 3/8npt-16mm p/i	1	1.31	6980	3mm cotter / r grip	1	8.3
6727NPT	elbow stud 1/4npt-1/2 p/i	1	1.32	6813	bulkhead conn m22x1.5-10mm	1	1.29	6981	3.5mm cotter / r grip	1	8.3
6727NPT	elbow stud 1/4npt-1/2 p/i	1	1.32	6816	bulkhead conn m22x1.5-12mm	1	1.29	6982	4mm cotter / r grip	1	8.3
6728	elbow stud 3/8bsp-1/2 p/i	1	1.32	6821	tee male branch adpt m12x1.5	1	1.29	6983	5mm cotter / r grip	1	8.3
6728NPT	elbow stud 3/8npt-1/2 p/i	1	1.32	6822	tee male branch adpt m16x1.5	1	1.29	6984	6mm cotter / r grip	1	8.3
6728NPT	elbow stud 3/8npt-1/2 p/i	1	1.32	6823	tee male branch adpt m22x1.5	1	1.29	6990	6mm lynch pin with o ring	1	8.3
6729	elbow stud 3/8bsp-3/8 p/i	1	1.32	6826	tee male side adapt m16x1.5	1	1.29	6991	8mm lynch pin with o ring	1	8.3
6729NPT	elbow stud 3/8npt-3/8 p/i	1	1.32	6827	tee male side adapt m22x1.5	1	1.29	6992	11mm lynch pin with o ring	1	8.3
6729NPT	elbow stud 3/8npt-3/8 p/i	1	1.32	6901	flaring tool 5 piece	1	7.3	7000	assorted box male brake pipe nuts	1	5.6
6730	elbow stud 1/2bsp-3/8 p/i	1	1.32	6901	flaring tool 5 piece	1	8.11	7001	male nut 3/16od 3/8x24tpi pkt10	10	5.2
6731	elbow stud 1/2bsp-1/2 p/i	1	1.32	6901.1	punch & die set 12mm	1	5.9	7002	male nut 3/16od 3/8x20tpi pkt10	10	5.2
6731NPT	elbow stud 1/2npt-1/2 p/i	1	1.32	6901.1	punch & die set 12mm	1	7.3	7003	male nut 1/4od 10x1.25mm pkt10	10	5.2
6731NPT	elbow stud 1/2npt-1/2 p/i	1	1.32	6901.3	punch & die set 5/16	1	5.9	7004	male nut short 3/16od 10x1.25mm	10	5.2
6733NPT	elbow stud 3/8npt-5/8 p/i	1	1.32	6901.3	punch & die set 5/16	1	7.3	7005	male nut long 3/16od 10x1mm pkt10	10	5.2
6733NPT	elbow stud 3/8npt-5/8 p/i	1	1.32	6901.7	punch & die set 6mm	1	5.9	7006	male nut 3/16od 10x1mm pkt10	10	5.3
6755	straight stud 1/8bsp-6mm p/i	1	1.31	6901.7	punch & die set 6mm	1	7.3	7007	male nut short 3/16od 10x1mm	10	5.3
6755NPT	straight stud 1/8npt-6mm p/i	1	1.31	6901M	flaring tool 5 piece metric	1	7.3	7008	male nut 3/16od 10x1mm tte datsun	10	5.3
6756	straight stud 1/8 bsp-8mm p/i	1	1.31	6901M	flaring tool 5 piece metric	1	8.11	7009	male nut 3/16od 12x1mm pkt5	5	5.3
6756NPT	straight stud 1/8npt-8mm p/i	1	1.31	6902	o clip pincers	1	6.5	7010	male nut 1/4od 7/16x20tpi pkt10	10	5.3
6759	straight stud 1/4bsp-6mm p/i	1	1.31	6902	o clip pincers	1	6.5	7011	male nut 5/16od 1/2x20tpi pkt5	5	5.4
6759NPT	straight stud 1/4npt-6mm p/i	1	1.31	6904	grease gun side lever	1	8.4	7012	male nut short 5/16od 1/2x20tpi pkt5	5	5.4
6760	straight stud 1/4 bsp-8mm p/i	1	1.31	6905	grease flexi hose 12" 1/8in bsp	1	8.3	7013	male nut 3/8od 5/8x18tpi pkt5	5	5.5
6760NPT	straight stud 1/4npt-8mm p/i	1	1.31	6905.18	grease flexi hose 18" 1/8in bsp	1	8.3	7015	male nut 3/16od 7/16x24tpi pkt10	10	5.2
6761	straight stud 1/8 bsp-10mm p/i	1	1.31	6905.24R	grease flexi hose 24" 1/8in	1	8.3	7016	male nut 1/4od 1/2x20tpi pkt5	5	5.3
6762	straight stud 1/4 bsp-10mm p/i	1	1.31	6906	slide on knuckle conn	1	8.3	7018	male nut 1/4od 12x1mm pkt5	5	5.4
6762NPT	straight stud 1/4npt-10mm p/i	1	1.31	6907	push on connector 1/8 bsp	1	8.3	7019	male nut 3/16od 7/16x20tpi pkt10	10	5.2
6763	straight stud 1/4 bsp-12mm p/i	1	1.31	6908	grease bucket pump 12.5kg	1	8.4	7020	male nut 3/16od 3/8x24tpi tte pkt10	10	5.2
6763NPT	straight stud 1/4npt-12mm p/i	1	1.31	6909	quick release coupler 1/8 bsp	1	8.3	7021	male nut 1/4od 1/2x20short pkt5	5	5.4
6764	straight stud 3/8 bsp-10mm p/i	1	1.31	6910	tube cutters	1	6.7	7022	long nut 3/16od 3/8x24tpi pkt10	10	5.2
6764NPT	straight stud 3/8npt-10mm p/i	1	1.31	6910	tube cutters	1	8.11	7023	male nut 3/16od 10x1.25mm tte	10	5.2
6765NPT	straight stud 1/2npt-16mm p/i	1	1.31	6911	spare blade for 6910	1	6.7	7024	male nut 5/16od 1/2x20tpi pkt5	5	5.4
6766	straight stud 3/8 bsp-12mm p/i	1	1.31	6911	spare blade for 6910	1	8.11	7025	male nut long 6mmod 12x1mm pkt3	3	5.4
6766NPT	straight stud 3/8npt-12mm p/i	1	1.31	6913	hook on connector	1	8.3	7026	male nut 8mmod m14x1.5 pkt3	3	5.4
6767	straight stud 1/2 bsp-10mm p/i	1	1.31	6914	tube and hose cutter	1	6.7	7028	push in end fitting 8x1mm(m18x1.5)	1	1.22
6767NPT	straight stud 1/2 npt-10mm p/i	1	1.31	6914	tube and hose cutter	1	8.11	7029	push in end fitting 10x1mmmm18x1.5	1	1.22
6768	straight stud 1/2 bsp-12mm p/i	1	1.31	6915	blades for 6914	1	6.7	7030	push-in end fitting 6x1mm	1	1.22
6768NPT	straight stud 1/2npt-12mm p/i	1	1.31	6915	blades for 6914	1	8.11	7030A	assorted box wira end fittings	1	1.22
6769NPT	straight stud 3/8npt-16mm p/i	1	1.31	6918	slide on connector	1	8.3	7031	push-in end fitting 8x1mm	1	1.22
6770	straight stud m10x1-1/4 p/i	1	1.33	6920	blow gun palm held conical noz	1	3.15	7031.5	push-in end fitting 8x1.5mm	1	1.22
6771	straight stud m12x1.5-1/4 p/i	1	1.33	6922	plastic blow gun	1	3.15	7032	push-in end fitting 9x1.5mm	1	1.22
6772	straight stud m16x1.5-1/4 p/i	1	1.33	6926	plastic blow gun	1	3.15	7033	push-in end fitting 10x1.25mm	1	1.22
6773	straight stud m16x1.5-3/8 p/i	1	1.33	6928	blow gun plastic	1	3.15	7033.1	push-in end fitting 10x1mm	1	1.22
6774	straight stud m22x1.5-3/8 p/i	1	1.33	6929	pistol grip blow gun	1	3.15	7033.5	push-in end fitting 10x1.5mm	1	1.22
6775	straight stud m16x1.5-1/2 p/i	1	1.33	6930	air line gauge 6ft hose	1	3.15	7034	push-in end fitting 11x1.5mm	1	1.22
6776	straight stud m22x1.5-1/2 p/i	1	1.33	6931	inflator twin hold on open end	1	3.15	7035	push-in end fitting 12x1.5mm	1	1.22
6777	straight stud m16x1.5-5/8 p/i	1	1.33	6932	inflator twin clip on open end	1	3.15	7037	push-in end fitting 15x1.5mm	1	1.22
6786	stud elbow 1/8bsp-6mm p/i	1	1.30	6934	single clip-on open 1/4hose	1	3.15	7037.2	push-in end fitting 15x2mm	1	1.22
6786NPT	stud elbow 1/8npt-6mm p/i	1	1.31	6935	plastic spray bottle chem resist	1	8.6	7038	push-in end fitting 16x2mm	1	1.22
6787	stud elbow 1/8 bsp-8mm p/i	1	1.30	6936	brake cleaner & chem sprayer	1	8.6	7039	push-in end fitting 18x2mm	1	1.22
6790	stud elbow 1/4 bsp-6mm p/i	1	1.30	6937	12.5kg auto lube filler pump	1	8.4	7041	straight stud m10x1-6x1mm	1	1.21
6790NPT	stud elbow 1/4npt-6mm p/i	1	1.31	6938	50kg air op greaser kit	1	8.5	7042	straight stud m12x1.5-6x1mm	1	1.21
6791	stud elbow 1/4 bsp-8mm p/i	1	1.30	6939	grease control gun & z swivel	1	8.5	7043	straight stud m14x1.5-6x1mm	1	1.21
6791NPT	stud elbow 1/4 npt-8mm p/i	1	1.31	6940	lever drum pump	1	8.7	7044	straight stud m16x1.5-6x1mm	1	1.21
6792	stud elbow 1/4 bsp-10mm p/i	1	1.30	6941	drum pump	1	8.8	7045	straight stud m22x1.5-6x1mm	1	1.21
6792NPT	stud elbow 1/4 npt-10mm p/i	1	1.31	6942	submersible 12v electric pump	1	8.7	7046	straight stud 1/4npt-8x1mm	1	1.21
6794	stud elbow 1/4 bsp-12mm p/i	1	1.30	6943	elec pump dispenser kit 12/24	1	8.8	7047	straight stud m10x1-8x1mm	1	1.21
6794NPT	stud elbow 1/4 npt-12mm p/i	1	1.31	6944	auto diesel shut off nozzle	1	8.7	7048	straight stud m12x1.5-8x1mm	1	1.21
6797	stud elbow 3/8 bsp-8mm p/i	1	1.30	6945	1/4"bspf dry brake coupling	1	8.4	7049	straight stud m14x1.5-8x1mm	1	1.21
6797NPT	stud elbow 3/8 npt-8mm p/i	1	1.31	6947	6" anti spill flexi spout funnel	1	8.6	7050	straight stud m16x1.5-8x1mm	1	1.21
6799	stud elbow 3/8 bsp-10mm p/i	1	1.30	6948	9" anti spill flexi spot funnel	1	8.6	7051	straight stud m22x1.5-8x1mm	1	1.21
6799NPT	stud elbow 3/8 npt-10mm p/i	1	1.31	6952	5 ltr flexi spout oil measure	1	8.6	7052	straight stud m12x1.5-9x1.5mm	1	1.21
6801	stud elbow 3/8 bsp-12mm p/i	1	1.30	6960	chemical barrel syphon pump	1	8.8	7053	straight stud m16x1.5-9x1.5mm	1	1.21
6801NPT	stud elbow 3/8npt-12mm p/i	1	1.31	6961	adblue & chemical piston pump	1	8.8	7054	straight stud m22x1.5-9x1.5mm	1	1.21
6803	stud elbow 1/2 bsp-8mm p/i	1	3.3	6962	adblue rotary barrel hand pump	1	8.9	7055	straight stud 1/4npt-10x1.25mm	1	1.21
6805	stud elbow 1/2 bsp-10mm p/i	1	1.30	6963	adblue manual nozzle	1	8.9	7056	straight stud m10x1-10x1.25mm	1	1.21
6807	stud elbow 1/2 bsp-12mm p/i	1	1.30	6964	adblue ibc gravity feed kit	1	8.9	7057	straight stud m12x1.5-10x1.25mm	1	1.21

Part No.	Description	Qty	Page	Part No.	Description	Qty	Page	Part No.	Description	Qty	Page
7503	grease nipple straight 5/16bsf	15	8.2	7618T	adaptor m16x1.5-1/2bsp m/f t&o	1	2.7	7671G	locknut m12x1.5	1	2.3
7504	grease nipple straight 1/4unf	10	8.2	7619	adaptor 3/8bsp-m22x1.5 m/f	1	2.7	7672G	locknut m14x1.5	1	2.3
7505	grease nipple long 1/4unf	10	8.2	7620	plug m10x1mm	1	2.3	7673G	locknut m16x1.5	1	2.3
7506	grease nipple straight 1/4bsp	6	8.2	7620C	plug m10x1mm c/w copper washer	1	2.3	7674G	locknut m18x1.5	1	2.3
7507	grease nipple straight 6x1mm	10	8.2	7620T	m10 plug c/w t&o	1	2.3	7675G	locknut m22x1.5	1	2.3
7508	grease nipple straight 8x1mm	10	8.2	7621	plug m12x1.5	1	2.3	7676G	locknut m26x1.5	1	2.3
7509	grease nipple straight 8x1.25mm	10	8.2	7621SB	brass blanking plug m12x1.5	1	1.15	7677G	straight stud 1/4npt-10mm	1	2.10
7510	grease nipple straight 10x1mm	10	8.2	7621ST	plug m12x1.5 hex socket t&o	1	2.3	7678G	straight stud 1/4npt-12mm	1	2.10
7511	grease nipple straight 10x1.5m	10	8.2	7621T	m12x1.5 plug t&o	1	2.3	7679G	straight stud 3/8npt-12mm	1	2.10
7512	grease nipple 90deg 1/8bsp	10	8.2	7622	plug m16x1.5	1	2.3	7680G	tube nut 6mmod	1	2.3
7517	grease nipple 90deg 6x1mm	10	8.2	7622SB	brass blanking plug m16x1.5	1	1.15	7681G	tube nut 8mmod	1	2.3
7520	grease nipple 45deg 1/8bsp	10	8.2	7622ST	plug m16x1.5 hex socket t&o	1	2.3	7682G	tube nut 10mmod	1	2.3
7525	grease nipple 45deg 8x1mm	8	8.2	7622T	plug m16 t&o	1	2.3	7683G	tube nut 12mmod	1	2.3
7526	grease nipple 45deg 8x1.25mm	8	8.2	7623	plug m22x1.5	1	2.3	7684G	tube nut 15mmod	1	2.3
7527	grease nipple 45deg 10x1mm	8	8.2	7623SB	brass blanking plug m22x1.5	1	1.15	7685G	tube nut 16mmod	1	2.3
7528	grease nipple 45deg 10x1.5mm	8	8.2	7623ST	plug m22x1.5 hex socket t&o	1	2.3	7686G	tube nut 18mmod	1	2.3
7576	ali port adaptor offset legs	1	2.8	7623T	plug m22 t&o ring	1	2.3	7687G	hose nut for 7779g	1	2.5
7577	15mm - m26x1.5 stud conn p/i	1	1.21	7624	plug m14x1.5	1	2.3	7687G	hose nut for 7779g	1	2.9
7578	ali port adaptor unequal legs	1	2.8	7624T	plug m14x1.5 t&o	1	2.3	7688G	tube nut long 15mm	1	2.5
7579	ali port adaptor equal legs	1	2.8	7625	plug m18x1.5	1	2.3	7690	cutting ring 6mm	1	2.5
7584	cutting ring 4mm	1	2.5	7625T	plug m18x1.5 c/w t&o	1	2.3	7691	cutting ring 8mm	1	2.5
7585	adaptor m26x1.5-m22x1.5 m/f	1	2.7	7627	adaptor male m16x1.5-m26x1.5	1	2.6	7692	cutting ring 10mm	1	2.5
7585T	adaptor m26x1.5-m22x1.5 m/f t&o	1	2.7	7627T	adaptor male m16x1.5-m26x1.5 t/o	1	2.6	7693	cutting ring 12mm	1	2.5
7586	socket m14x1.5	1	2.6	7628	drain tap m22x1.5	1	2.3	7694	cutting ring 15mm	1	2.5
7587	socket m12x1.5	1	2.6	7628T	drain valve m22x1.5 c/w t&o	1	2.3	7695	cutting ring 16mm	1	2.5
7588	adaptor m12x1.5-1/4bsp m/f	1	2.7	7629T	drain tap m22x1.5 c/w cable & t&o	1	2.3	7696	cutting ring 18mm	1	2.5
7589	assorted box m/f metric/imp	1	2.7	7630	aluminium seal m10	1	2.4	7700	adaptor m/f m16x1.5-m10x1	1	2.7
7590	assorted box m/f adpt imp/metric	1	2.7	7631	aluminium seal m12	1	2.4	7700T	adaptor m/f m16x1.5-m10x1	1	2.7
7591	socket m18x1.5-m22x1.5	1	2.6	7632	aluminium seal m14	1	2.4	7701G	socket m16x1.5-m12x1.5 fem	1	2.6
7592	thrust ring m26	1	2.4	7633	aluminium seal m16	1	2.4	7702	socket m22x1.5-m16x1.5	1	2.6
7593	o ring m26	1	2.4	7634	aluminium seal m18	1	2.4	7703	socket m22x1.5-3/8bsp	1	2.6
7594	adaptor m12x1.5-m16x1.5 m/f	1	2.7	7635	aluminium seal m22	1	2.4	7704	adaptor m12x1.5-m22x1.5 m/f	1	2.7
7594T	adaptor m12x1.5-m16x1.5 m/f t&o	1	2.7	7635A	assorted box aluminium seals	1	2.4	7705G	adaptor m14x1.5-m22x1.5 m/f	1	2.7
7595	adaptor m14x1.5-m16x1.5 m/f	1	2.7	7636	aluminium seal m26	1	2.4	7705T	adaptor m14x1.5-m22x1.5 m/f	1	2.7
7595T	adaptor m14x1.5-m16x1.5 m/f t&o	1	2.7	7638	assorted box thrust and o rings	1	2.4	7706G	straight stud m18x1.5-12mm	1	2.10
7596	adaptor 1/4bsp -m12x1.5 m/f	1	2.7	7639	assorted box cutting rings	1	2.5	7707G	straight stud m16x1.5-6mm	1	2.10
7598	adaptor 1/2bspt-m18x1.5 m/f	1	2.7	7640	thrust ring m10	1	2.4	7707T	straight stud m16x1.5-6 c/w to	1	2.10
7599	adaptor 1/4bsp-3/8bsp m/f	1	2.7	7641	thrust ring m12	1	2.4	7708	cone ring 15mm	1	2.5
7600	adaptor m16x1.5-m16x1.5 m/f	1	2.7	7642	thrust ring m14	1	2.4	7709	cone ring 16mm	1	2.5
7601	adaptor m22x1.5-1/8bsp m/f	1	2.7	7643	thrust ring m16	1	2.4	7711G	straight stud m12x1.5-6mm	1	2.10
7602	adaptor m22x1.5-1/4bsp m/f	1	2.7	7644	thrust ring m18	1	2.4	7711T	straight stud m12x1.5-6mm t/o	1	2.10
7602T	adaptor m22x1.5-1/4bsp m/f t&o	1	2.7	7645	thrust ring m22	1	2.4	7712G	straight stud m10x1mm-10mm	1	2.10
7603	adaptor m22x1.5-3/8bsp m/f	1	2.7	7646	nitrile o ring m10	1	2.4	7712T	straight stud m10x1mm-10 t/o	1	2.10
7603T	adaptor m22x1.5-3/8bsp m/f t&o	1	2.7	7647	nitrile o ring m12 (10x2.2)	1	2.4	7713G	straight stud m12x1.5-8mm	1	2.10
7604	adaptor m22x1.5-m16x1.5 m/f	1	2.7	7648	nitrile o ring m14	1	2.4	7713T	straight stud m12x1.5-8mm t/o	1	2.10
7604T	adaptor m22x1.5-m16x1.5 m/f t&o	1	2.7	7649	nitrile o ring m16	1	2.4	7714G	straight stud m14x1.5-8mm	1	2.10
7605	adaptor m22x1.5-m12x1.5 m/f	1	2.7	7650	nitrile o ring m18	1	2.4	7714T	straight stud m14x1.5-8mm t/o	1	2.10
7605T	adaptor m22x1.5-m12x1.5 m/f t&o	1	2.7	7651	nitrile o ring m22	1	2.4	7715G	straight stud m16x1.5-8mm	1	2.10
7606	adaptor m16x1.5-1/4bsp m/f	1	2.7	7652	copper seal m10	1	2.4	7715T	straight stud m16x1.5-8mm t/o	1	2.10
7606NPT	adaptor m16x1.5-1/4npt m/f	1	2.7	7653	copper seal m12	1	2.4	7716G	straight stud m22x1.5-8mm	1	2.10
7606T	adaptor m16x1.5-1/4bsp m/f t&o	1	2.7	7654	copper seal m14	1	2.4	7716T	straight stud m22x1.5-8mm t/o	1	2.10
7607	adaptor 1/2bsp-m16x1.5 m/f	1	2.7	7655	copper seal m16	1	2.4	7717G	straight stud m12x1.5-10mm	1	2.10
7608	socket m22x1.5-1/2bsp	1	2.6	7656	copper seal m18	1	2.4	7717T	straight stud m12-10mm t/o	1	2.10
7609G	socket m22x1.5 - m22x1.5	1	2.6	7657	copper seal m22	1	2.4	7718G	straight stud m14x1.5-10mm	1	2.10
7610G	socket m16x1.5-m16x1.5	1	2.6	7657A	assorted box copper seals	1	2.4	7718T	straight stud m14x1.5-10mm t/o	1	2.10
7611	adaptor 1/4bsp-m16x1.5 m/f	1	2.7	7659	fibre seal 12x19mm	1	2.5	7719G	straight stud m16x1.5-10mm	1	2.10
7612	adaptor 1/4bsp- m22x1.5 m/f	1	2.7	7660	fibre seal 14x18mm	1	2.5	7719T	straight stud m16x1.5-10mm t/o	1	2.10
7613	adaptor 1/2bsp-m22x1.5 m/f	1	2.7	7661	nitrile o ring 9.5mm x 12.5mm	1	2.4	7720G	straight stud m22x1.5-10mm	1	2.10
7614	adaptor m22x1.5-1/2bsp m/f	1	2.7	7662	nitrile o ring 21.6mm x 23mm	1	2.4	7720T	straight stud m22x1.5-10mm t/o	1	2.10
7614T	adaptor m22x1.5-1/2bsp m/f t&o	1	2.7	7664	bonded rubber seal m10	1	2.4	7721G	straight stud m12x1.5-12mm	1	2.10
7615	adaptor 3/8bsp-m16x1.5 m/f	1	2.7	7665	bonded rubber seal m12	1	2.4	7722G	straight stud m16x1.5-12mm	1	2.10
7616	adaptor m16x1.5-3/8bsp m/f	1	2.7	7666	bonded rubber seal m14	1	2.4	7722T	straight stud m16x1.5-12mm t/o	1	2.10
7616NPT	adaptor m16x1.5-3/8npt m/f t&o	1	2.7	7667	bonded rubber seal m16	1	2.4	7723G	straight stud m22x1.5-12mm	1	2.10
7616T	adaptor m16x1.5-3/8bsp m/f t&o	1	2.7	7668	bonded rubber seal m18	1	2.4	7723T	straight stud m22x1.5-12mm t/o	1	2.10
7617	adaptor m16x1.5-m22x1.5 m/f	1	2.7	7669	bonded rubber seal m22	1	2.4	7726G	straight stud m16x1.5-15mm	1	2.10
7617T	adaptor m16x1.5-m22x1.5 m/f t&o	1	2.7	7669A	assorted box bonded seals	1	2.4	7726T	straight stud m16x1.5-15mm t/o	1	2.10
7618	adaptor m16x1.5-1/2bsp m/f	1	2.7	7670G	straight stud 3/8 npt-10mm	1	2.10	7727G	straight stud m22x1.5-15mm	1	2.10

Part No.	Description	Qty	Page	Part No.	Description	Qty	Page	Part No.	Description	Qty	Page
7727T	straight stud m22x1.5-15mm t/o	1	2.10	7780T	elbow stud m12x1.5-8mm t/o	1	2.12	7839G	tee test point 12mm od	1	2.16
7728G	straight stud m22x1.5-18mm	1	2.10	7781G	elbow stud m12x1.5-10mm	1	2.12	7842G	tee test point m22x1.5-10mm	1	2.16
7728T	straight stud m22x1.5-18mm t/o	1	2.10	7781T	elbow stud m12x1.5-0mm t/o	1	2.12	7843G	tee test point m16x1.5-10mm	1	2.16
7729G	straight stud m10x1mm-8mm	1	2.10	7782G	elbow stud m14x1.5-10mm	1	2.12	7843T	tee test point m16x1.5-10mm t/o	1	2.16
7729T	straight stud m10x1mm-8mm t/o	1	2.10	7782T	elbow stud m14x1.5-10mm t/o	1	2.12	7847G	tee test point m12x1.5-10mm od	1	2.16
7730G	reducing conn 22mm-18mm od	1	2.10	7783G	elbow stud m16x1.5-10mm	1	2.12	7848G	tee stud m12x1.5 - 8mm	1	2.14
7731G	straight stud m22x1.5-16mm	1	2.10	7783T	elbow stud m16x1.5-10mm t/o	1	2.12	7849G	tee bulkhead m22x1.5	1	2.15
7731T	straight stud m22x1.5-16mm t/o	1	2.10	7784G	elbow stud m22x1.5-10mm	1	2.12	7850G	elbow conn m22x1.5 male	1	1.27
7732G	straight stud m10x1mm-6mm	1	2.10	7784T	elbow stud m22x1.5-10mm t/o	1	2.12	7850G	elbow conn m22x1.5 male	1	2.12
7733G	straight conn 6mm od	1	2.10	7785G	elbow stud m22x1.5x12mm	1	2.12	7850T	elbow conn m22x1.5 male t/o	1	1.27
7734G	straight conn 8mm od	1	2.10	7785T	elbow stud m22x1.5-12mm t/o	1	2.12	7850T	elbow conn m22x1.5 male t/o	1	2.12
7735G	straight conn 10mm od	1	2.10	7786G	elbow stud m22x1.5-15mm	1	2.12	7853G	stem tee branch 10mm od	1	2.13
7736G	straight conn 12mm od	1	2.10	7786T	elbow stud m22x1.5-15mm t/o	1	2.12	7854G	stem tee side 10mm od	1	2.14
7737G	straight conn 15mm od	1	2.10	7787G	elbow stud m22x1.5-18mm	1	2.12	7855G	elbow stud 3/8npt-10mm od	1	2.12
7738G	straight conn 16mm od	1	2.10	7787T	elbow stud m22x1.5-18mm t/o	1	2.12	7857G	hosetail swivel m16x1.5fem-11mmid	1	2.9
7739G	straight conn 18mm od	1	2.10	7788G	elbow stud m22x1.5-16mm	1	2.12	7858G	hosetail swivel 10mmod-3/8id	1	2.9
7740G	bulkhead conn m22x1.5-m14x1.5	1	1.27	7788T	elbow stud m22x1.5-16mm t/o	1	2.12	7859G	hosetail stem 12mmod-13mm id gold	1	2.9
7740G	bulkhead conn m22x1.5-m14x1.5	1	2.11	7789G	elbow stud m16x12mm	1	2.12	7860G	adaptor male m12x1.5-m12x1.5	1	2.6
7740T	bulkhead conn m22x1.5-m14x1.5	1	1.27	7789T	elbow stud m16x1.5-12mm t/o	1	2.12	7860T	adaptor male m12x1.5-m12x1.5 t/o	1	2.6
7740T	bulkhead conn m22x1.5-m14x1.5	1	2.11	7790G	elbow bulkhead 6mm od	1	2.12	7861G	adaptor male m12x1.5-m14x1.5	1	2.6
7741G	bulkhead conn m22x1.5-m16x1.5	1	1.27	7791G	elbow bulkhead 8mm od	1	2.12	7861T	adaptor male m12x1.5-m14x1.5	1	2.6
7741G	bulkhead conn m22x1.5-m16x1.5	1	2.11	7792G	elbow bulkhead 10mmod	1	2.12	7862G	adaptor male m12x1.5-m16x1.5	1	2.6
7741T	bulkhead conn m22x1.5-m16x1.5	1	1.27	7793G	elbow bulkhead 12mm od	1	2.12	7862T	adaptor male m12x1.5-m16x1.5	1	2.6
7741T	bulkhead conn m22x1.5-m16x1.5	1	2.11	7794G	elbow bulkhead 15mm od	1	2.12	7863G	adaptor male m12x1.5-m18x1.5	1	2.6
7742G	bulkhead conn m22x1.5	1	1.27	7795G	elbow stud 3/8npt-12mm od	1	2.12	7864G	adaptor male m12x1.5-m22x1.5	1	2.6
7742G	bulkhead conn m22x1.5	1	2.11	7798G	elbow bulkhead m22x1.5-8mm	1	2.12	7865G	adaptor male m14x1.5-m14x1.5	1	2.6
7742T	bulkhead conn m22x1.5 t/o	1	1.27	7799G	elbow standpipe 10mm od	1	2.12	7866D	adaptor m m14x1.5din-m16x1.5	1	2.6
7742T	bulkhead conn m22x1.5 t/o	1	2.11	7800G	elbow conn 6mm od	1	2.12	7866G	adaptor male m14x1.5-m16x1.5	1	2.6
7743G	bulkhead conn m16x1.5-10mm	1	2.11	7801G	elbow conn 8mm od	1	2.12	7866T	adaptor male m14x1.5-m16x1.5	1	2.6
7743T	bulkhead conn m16x1.5-10mm t/o	1	2.11	7802G	elbow conn 10mm od	1	2.12	7867G	adaptor male m14x1.5-m22x1.5	1	2.6
7744G	bulkhead conn m22x1.5-10mm	1	2.11	7803G	elbow conn 12mm od	1	2.12	7868G	adaptor male m16x1.5 - m16x1.5	1	2.6
7744T	bulkhead conn m22x1.5-10mm to	1	2.11	7804G	elbow conn 15mm od	1	2.12	7868T	adaptor male m16x1.5 - m16x1.5	1	2.6
7745G	bulkhead conn m22x1.5-12mm	1	2.11	7805G	elbow conn 16mm od	1	2.12	7869G	adaptor male m16x1.5-m22x1.5	1	2.6
7745T	bulkhead conn m22x1.5-12mm t/o	1	2.11	7806G	elbow conn 18mm od	1	2.12	7869T	adaptor male m16x1.5-m22x1.5	1	2.6
7746G	bulkhead conn m22x1.5-15mm	1	2.11	7807G	elbow stud1/4npt-10mm od	1	2.12	7870G	adaptor male m18x1.5-m18x1.5	1	2.6
7746T	bulkhead conn m22x1.5-15mm t/o	1	2.11	7808G	elbow conn male/fem m16x1.5	1	2.13	7871T	adaptor male m18x1.5-m22x1.5	1	2.6
7748G	bulkhead conn 6mm od	1	2.11	7808T	elbow conn male/fem m16x1.5 t/o	1	2.13	7872G	adaptor male m22x1.5-m22x1.5	1	2.6
7749G	bulkhead conn 8mm od	1	2.11	7809G	elbow conn male/fem m22x1.5	1	2.13	7872T	adaptor male m22x1.5-m22x1.5	1	2.6
7750G	bulkhead conn 10mm od	1	2.11	7809T	elbow conn male/fem m22x1.5 t/o	1	2.13	7873G	adaptor male m22x1.5-m26x1.5	1	2.6
7751G	bulkhead conn 12mm od	1	2.11	7810G	tee conn 6mm od	1	2.13	7873T	adaptor male m22x1.5-m26x1.5	1	2.6
7752G	bulkhead conn 15mm od	1	2.11	7811G	tee conn 8mm od	1	2.13	7874G	adaptor male 1/8npt-m12x1.5	1	2.6
7753G	bulkhead conn 16mm od	1	2.11	7812G	tee conn 10mm od	1	2.13	7875G	adaptor male 1/4npt-m12x1.5	1	2.6
7754G	bulkhead conn 18mm od	1	2.11	7813G	tee conn 12mm od	1	2.13	7876G	adaptor male 1/4npt-m14x1.5	1	2.6
7755G	bulkhead conn 1/2bsp-m22x1.5	1	1.27	7814G	tee conn 15mm od	1	2.13	7877G	adaptor male 1/4npt-m16x1.5	1	2.6
7755G	bulkhead conn 1/2bsp-m22x1.5	1	2.11	7815G	tee conn 16mm od	1	2.13	7877T	adaptor male 1/4npt-m16x1.5 t/o	1	2.6
7756G	bulkhead conn m22x1.5-8mm	1	2.11	7816G	tee conn 18mm od	1	2.13	7878G	adaptor male 3/8npt-m16x1.5	1	2.6
7756T	bulkhead conn m22x1.5 8mm to	1	2.11	7817G	tee stud m22x1.5-10mm	1	2.14	7879G	adaptor male 1/2npt-m22x1.5	1	2.6
7757G	female stud m22x1.5-6mm	1	2.11	7818G	tee stud m22x1.5-12mm	1	2.14	7879T	adaptor male 1/2npt-m22x1.5t/o	1	2.6
7759G	female stud m22x1.5-8mm	1	2.11	7819G	tee stud m22x1.5-15mm	1	2.14	7881G	tee stud m16x1.5-10mm	1	2.14
7760G	bulkhead conn m22x1.5-m18x1.5	1	1.27	7822G	tee bulkhead 10mm od	1	2.15	7881T	tee stud m16x1.5-10mm t/o	1	2.14
7760G	bulkhead conn m22x1.5-m18x1.5	1	2.11	7828G	tee bulkhead m22x1.5-13mmhose	1	2.8	7882G	hosetail stem 10mmod-13mmid	1	2.9
7760VT	straight stud m22x1.5-22mm	1	2.10	7828G	tee bulkhead m22x1.5-13mmhose	1	2.13	7883G	stem elbow 8mm od	1	2.12
7761G	female stud m22x1.5-10mm	1	2.11	7828G	tee bulkhead m22x1.5-13mmhose	1	2.13	7884G	tee side stem 12mm od	1	2.14
7763G	female stud m22x1.5-12mm	1	2.11	7828T	tee bulkhead m22x1.5-13mm t/o	1	1.27	7885G	tee branch stem 12mm od	1	2.13
7765G	female stud m22x1.5-15mm	1	2.11	7828T	tee bulkhead m22x1.5-13mm t/o	1	2.8	7886G	straight stud m14x1.5-12mm	1	2.10
7770G	hosetail swivel m16x1.5f-13mmid	1	2.9	7828T	tee bulkhead m22x1.5-13mm t/o	1	2.13	7887G	tee bulkhead m22x1.5	1	1.27
7771G	hosetail swivel m18x1.5f-13mmid	1	2.9	7829G	tee stud m12x1.5-10mm	1	2.14	7887G	tee bulkhead m22x1.5	1	2.15
7772G	hosetail m16x1.5-11mmid	1	2.9	7829T	tee stud m12x1.5-10mm t/o	1	2.14	7887T	tee bulkhead m22x1.5 t/o	1	1.27
7772T	hosetail m16x1.5-11mmid t/o	1	2.9	7830	test point female m12x1.5	1	2.16	7887T	tee bulkhead m22x1.5 t/o	1	2.15
7773	hosetail m22x1.5-11mmid	1	2.9	7831	test point female m16x1.5	1	2.16	7889G	tee female m16x1.5	1	2.14
7773T	hosetail m22x1.5-11mmid t/o	1	2.9	7832	test point female m22x1.5	1	2.16	7890G	tee side stem 8mm od	1	2.14
7774	hosetail m16x1.5-13mmid	1	2.9	7833	test point male 1/4npt	1	2.16	7891G	tee branch stem 8mm od	1	2.13
7774T	hosetail m16x1.5-13mmid t/o	1	2.9	7834	test point male m12x1.5	1	2.16	7893G	elbow stem 12mmod	1	2.12
7775G	hosetail m22x1.5-13mmid	1	2.9	7834T	test point male m12x1.5 t/o	1	2.16	7894	hosetail m16x1.5-3/8id	1	2.9
7775T	hosetail m22x1.5-13mmid t/o	1	2.9	7835T	test point male m16x1.5 t/o	1	2.16	7894T	hosetail m16x1.5-3/8id t/o	1	2.9
7779G	hosetail flat 13mmid	1	2.9	7836T	test point male m22x1.5 t/o	1	2.16	7895	hosetail swivel m16x1.5-13mmid	1	2.9
7780G	elbow stud m12x1.5-8mm	1	2.12	7838G	tee test point 10mm od	1	2.16	7895T	hosetail swivel m16x1.5-13mmid	1	2.9

Part No.	Description	Qty	Page	Part No.	Description	Qty	Page	Part No.	Description	Qty	Page
8615	adap 3/8npt-m16x1.5 m/f	2	2.7	9958	40 ltr air reservoir saddle	1	10.3	CAM530	straight stud m22x1.5 - 12x1.5	1	1.14
8616	adap m16x1.5-3/8bsp m/f	2	2.7	9961	60 ltr air reservoirs side mount	1	10.4	CAM533	straight stud m22x1.5 - 15mm p	1	1.14
8617	adap m16x1.5-m22 m/f	1	2.7	9962	60 ltr air reservoirs end mount	1	10.2	CAM536	straight stud m16x1.5 - 16mm p	1	1.14
8618	adap m16x1.5-1/2bsp m/f	1	2.7	9963	60 ltr air resevoirs saddle	1	10.3	CAM537	straight stud m22x1.5 - 16x2mm	1	1.14
8619	adap 3/8npt-m22x1.5 m/f	1	2.7	9964	60 ltr air reservoirs side mount	1	10.4	CAM573	straight stud m22x1.5 - 16mm p	1	1.17
8620	plug m10x1mm pkt2	2	2.3	9975	10/20ltr tank straps (pr)	PR	10.3	CAM574	elbow swivel c1 - 6x1mm pk1	1	1.17
8621	plug m12x1.5mm pkt2	2	2.3	9976	25/38ltr tank straps (pair)	PR	10.3	CAM575	elbow swivel c1 - 8x1mm pk1	1	1.17
8622	plug m16x1.5mm pkt2	2	2.3	9977	50/60ltr tank straps (pr)	PR	10.3	CAM576	elbow swivel c1 - 10x1.5mm pk1	1	1.17
8623	plug m22x1.5mm pkt2	2	2.3	9978	80ltr tank straps (pair)	PR	10.3	CAM577	elbow swivel c1 - 12x1.5mm pk1	1	1.17
8628	drain tap m22x1.5 pkt 1	1	2.3	CAM302	straight connector 6mm od pk2	2	1.13	CAM579	elbow c1 - m12x1.5 female	1	1.17
8632	aluminium seal m14 pkt10	10	2.4	CAM304	straight connector 8mm od pk1	1	1.13	CAM580	elbow c1 - m16x1.5 female	1	1.17
8633	aluminium seal m16 pkt10	10	2.4	CAM306	straight connector 10x1mm od p	1	1.13	CAM589	tee centre c1 - m12x1.5 pk1	1	1.17
8634	aluminium seal m18 pkt10	10	2.4	CAM306.25	straight connector 10x1.25 mm	1	1.13	CAM590	tee centre c1 - m16x1.5 pk1	1	1.17
8635	aluminium seal m22 pkt10	10	2.4	CAM306.5	straight connector 10x1.5 mm p	1	1.13	CAM591	tee side c1 - m12x1.5 pk1	1	1.17
8640	thrust & o ring m10 pkt10	10	2.4	CAM308	straight connector 12mm od pk1	1	1.13	CAM592	tee side c1 - m16x1.5 pk1	1	1.17
8641	thrust & o ring m12 pkt10	10	2.4	CAM311	straight connector 15mm od pk1	1	1.13	CAM595	tee female m22x1.5 pk1	1	1.15
8642	thrust & o ring m14 pkt10	10	2.4	CAM317	tee connector 6mm od pk1	1	1.15	CAM615	straight swivel c1 - m10x1 pk1	1	1.17
8643	thrust & o ring m16 pkt10	10	2.4	CAM319	tee connector 8mm od pk1	1	1.15	CAM616	straight swivel c1 - m12x1.5 p	1	1.17
8644	thrust & o ring m18 pkt10	10	2.4	CAM321	tee connector 10x1mm od pk1	1	1.15	CAM617	straight swivel c1 - m14x1.5 p	1	1.17
8645	thrust & o ring m22 pkt10	10	2.4	CAM321.5	tee connector 10mm x1.5 p/i pk	1	1.15	CAM618	straight swivel c1 - m16x1.5 p	1	1.17
8652	copper seal m10 pkt10	10	2.4	CAM323	tee connector 12x1.5mm od pk1	1	1.15	CAM619	straight swivel c1 - m22x1.5 p	1	1.17
8653	copper seal m12 pkt10	10	2.4	CAM333	elbow connector 6mm pk1	1	1.13	CAM7406	6mm tube release tool pk1	1	1.15
8654	copper seal m14 pkt10	10	2.4	CAM335	elbow connector 8mm pk1	1	1.13	CAM7406	6mm tube release tool pk1	1	1.17
8655	copper seal m16 pkt10	10	2.4	CAM337	elbow connector 10mm pk1	1	1.13	CAM7408	8mm tube release tool pk1	1	1.15
8656	copper seal m18 pkt10	10	2.4	CAM339	elbow connector 12mm pk1	1	1.13	CAM7408	8mm tube release tool pk1	1	1.17
8657	copper seal m22 pkt10	10	2.4	CAM402	elbow stud m12x1.5 - 6mm pk1	1	1.14	CAM7410	10mm tube release tool pk1	1	1.15
8659	fibre seal 12x19mm pkt10	10	2.5	CAM403	elbow stud m16x1.5 - 6mm pk1	1	1.14	CAM7410	10mm tube release tool pk1	1	1.17
8664	bonded seal m10 pkt10	10	2.4	CAM404	elbow stud m12x1.5 - 8mm pk1	1	1.14	CAM7412	12mm tube release tool pk1	1	1.15
8665	bonded seal m12 pkt10	10	2.4	CAM405	elbow stud m16x1.5 - 8mm pk1	1	1.14	CAM7412	12mm tube release tool pk1	1	1.17
8666	bonded seal m14 pkt6	6	2.4	CAM406	elbow stud m22x1.5 - 8mm pk1	1	1.14	CAM7415	15mm tube release tool pk1	1	1.15
8667	bonded seal m16 pkt10	10	2.4	CAM407	elbow stud m14x1.5 - 8mm pk1	1	1.14	CAM7415	15mm tube release tool pk1	1	1.17
8668	bonded seal m18 pkt8	8	2.4	CAM410	elbow stud m12x1.5 - 10x1mm	1	1.14	CAM7416	16mm tube release tool pk1	1	1.15
8669	bonded seal m22 pkt8	8	2.4	CAM410.25	elbow stud m12x1.5 - 10x1.25	1	1.14	CAM7416	16mm tube release tool pk1	1	1.17
8671	locknut m12x1.5 pkt10	10	2.3	CAM410.5	elbow stud m12x1.5 - 10x1.5mm	1	1.14	CC22060610	tee branch stud m10x1 - 6x1mm	1	1.13
8672	locknut m14x1.5 pkt8	8	2.3	CAM413	elbow stud m16x1.5 - 10x1mm	1	1.14	CC22060612	tee branch stud m12x1.5 - 6x1m	1	1.13
8673	locknut m16x1.5 pkt6	6	2.3	CAM413.25	elbow stud m16x1.5 - 10x1.25	1	1.14	CC22060616	tee branch stud m16x1.5 - 6x1m	1	1.13
8674	locknut m18x1.5 pkt6	6	2.3	CAM413.5	elbow stud m16x1.5 - 10x1.5mm	1	1.14	CC22080812	tee branch stud m12x1.5 - 8x1m	1	1.13
8675	locknut m22x1.5 pkt6	6	2.3	CAM414	elbow stud m22x1.5 - 10x1mm	1	1.14	CC22080816	tee branch stud m16x1.5 - 8x1m	1	1.13
8680	tube nut 6mm pkt10	10	2.3	CAM414.25	elbow stud m22x1.5 - 10x1.25	1	1.14	CC22080822	tee branch stud m22x1.5 - 8x1m	1	1.13
8681	tube nut 8mm pkt10	10	2.3	CAM414.5	elbow stud m12x1.5 - 10x1.5mm	1	1.14	CC23100606	tee stud run m10x1 - 6x1mm	1	1.14
8682	tube nut 10mm pkt8	8	2.3	CAM419	elbow stud m16x1.5 - 12x1.5mm	1	1.14	CC23120606	tee stud run m12x1.5 - 6x1mm	1	1.14
8683	tube nut 12mm pkt8	8	2.3	CAM420	elbow stud m22x1.5 - 12x1.5mm	1	1.14	CC23120808	tee stud run m12x1.5 - 8x1mm	1	1.14
8685	tube nut 16mm pkt2	2	2.3	CAM425	elbow stud m16x1.5 - 16mm pk1	1	1.14	CC23160808	tee stud run m16x1.5 - 8x1mm	1	1.14
8690	cutting ring 6mm pkt7	7	2.5	CAM426	elbow stud m22x1.5 - 16mm pk1	1	1.14	CC23161212	tee stud run m16x1.5 - 12x1.5m	1	1.14
8691	cutting ring 8mm pkt7	7	2.5	CAM502	straight stud m10x1 - 6x1mm pk	1	1.14	CC23161515	tee stud run m16x1.5 - 15x1.5m	1	1.14
8692	cutting ring 10mm pkt10	10	2.5	CAM503	straight stud m12x1.5 - 6x1mm	1	1.14	CC4502	straight stud m10x1 - 6x1mm p/	1	1.14
8693	cutting ring 12mm pkt8	8	2.5	CAM504	straight stud m14x1.5 - 6x1mm	1	1.14	CC4503	straight stud m12x1.5 - 6x1mm	1	1.14
8694	cutting ring 15mm pkt6	6	2.5	CAM505	straight stud m16x1.5 - 6x1mm	1	1.14	CC4504	straight stud m14x1.5 - 6mm p/	1	1.14
8695	cutting ring 16mm pkt6	6	2.5	CAM506	straight stud m22x1.5 - 6x1mm	1	1.14	CC4505	straight stud m16x1.5 - 6x1mm	1	1.14
8696	cutting ring 18mm pkt5	5	2.5	CAM507	straight stud m10x1 - 8x1mm pk	1	1.14	CC4506	straight stud m22x1.5 - 6x1mm	1	1.14
8742B	bulkhead conn m22-m22	1	1.27	CAM508	straight stud m12x1.5 - 8x1mm	1	1.14	CC4507	straight stud m10x1 - 8x1mm p/	1	1.14
8742B	bulkhead conn m22-m22	1	2.11	CAM509	straight stud m14x1.5 - 8x1mm	1	1.14	CC4508	straight stud m12x1.5 - 8x1mm	1	1.14
8907	push on conn 1/8 bsp pkt4	4	8.3	CAM510	straight stud m16x1.5 - 8x1mm	1	1.14	CC4509	straight stud m14x1 - 8x1mm p/	1	1.14
9100	diaphragm type 12	1	10.10	CAM511	straight stud m22x1.5 - 8x1mm	1	1.14	CC4510	straight stud m16x1.5x1 - 8x1m	1	1.14
9101	diaphragm type 16	1	10.10	CAM512	straight stud m10x1.5 - 10x1mm	1	1.14	CC4511	straight stud m22x1.5x1 - 8x1m	1	1.14
9102	diaphragm type 20	1	10.10	CAM513	straight stud m12x1.5 - 10x1mm	1	1.14	CC4512	straight stud m10x1 - 10mm p/i	1	1.14
9103	diaphragm type 24	1	10.10	CAM515	straight stud m16x1.5 - 10x1mm	1	1.14	CC4513	straight stud m12x1.5 - 10x1mm	1	1.14
9104	diaphragm type 30	1	10.10	CAM516	straight stud m22x1.5 - 10x1mm	1	1.14	CC4515	straight stud m16x1.5 - 10x1mm	1	1.14
9107	diaphragm type 20 l/s	1	10.10	CAM517	straight stud m12x1.5-10x1.25m	1	1.14	CC4516	straight stud m22x1.5 - 10x1mm	1	1.14
9108	diaphragm type 24 l/s	1	10.10	CAM519	straight stud m12x1.5 - 10x1.25	1	1.14	CC4517	straight stud m12x1.5 - 10x1.2	1	1.14
9277	sae straight conn 1/2 od	1	5.8	CAM520	straight stud m22x1.5 - 10x1.25	1	1.14	CC4519	straight stud m16x1.5 - 10x1.25	1	1.14
9288	sae straight conn 5/8 od	1	5.8	CAM522	straight stud m12x1.5 - 10x1.5	1	1.14	CC4520	straight stud m22x1.5 - 10x1.25	1	1.14
9355	sae tee conn 5/16 od	1	5.8	CAM524	straight stud m16x1.5 - 10x1.5	1	1.14	CC4522	straight stud m12x1.5 - 10x1.5	1	1.14
9366	sae tee conn 3/8 od	1	5.8	CAM525	straight stud m22x1.5 - 10x1.5	1	1.14	CC4524	straight stud m16x1.5 - 10x1.5	1	1.14
9940	10 ltr air resevoirs s/m	1	10.4	CAM527	straight stud m12x1.5 - 12x1.5	1	1.14	CC4525	straight stud m22x1.5 - 10x1.5	1	1.14
9946	20 ltr air resevoirs side	1	10.4	CAM528	straight stud m14x1.5 - 12x1.5	1	1.14	CC4527	straight stud m12x1.5 - 12x1.5	1	1.14
9956	50 ltr air reservoirs end	1	10.2	CAM529	straight stud m16x1.5 - 12x1.5	1	1.14	CC4528	straight stud m14x1.5 - 12x1.5	1	1.14

Part No.	Description	Qty	Page	Part No.	Description	Qty	Page	Part No.	Description	Qty	Page
CC4529	straight stud m16x1.5 - 12x1.5	1	1.14	CC6830	y fitting m16x1.5 - 8x1mm	1	1.15	MAB058	stud conn m16x1.5-12mm	2	2.10
CC4530	straight stud m22x1.5 - 12x1.5	1	1.14	CC6831	y fitting m22x1.5 - 12x1.5mm	1	1.15	MAB059	stud conn m22x1.5-12mm	2	2.10
CC4533	straight stud m22x1.5 - 15x1.5	1	1.14	CC6840	f fitting m22x1.5 - 12x1.5mm	1	1.15	MAB070	stud conn m22x1.5-15mm	1	2.10
CC4536	straight stud m16x1.5 - 16x2mm	1	1.14	CC6850	cross fitting m16x1.5	1	1.14	MAB071	stud conn m22x1.5-16mm	1	2.10
CC4537	straight stud m22x1.5 - 16x2mm	1	1.14	CC6860	3 way block m16x1.5	1	1.15	MAB072	stud conn m22x1.5-18mm	1	2.10
CC4573	elbow swivel c1 - 6x1mm p/i	1	1.17	CC6861	3 way block m16 f m22 m	1	1.15	MAB078	bulkhead conn m22x1.5 pkt1	1	1.27
CC4574	elbow swivel c1 - 8x1mm p/i	1	1.17	CC7400A	Camozzi Release Tools	1	1.15	MAB078	bulkhead conn m22x1.5 pkt1	1	2.11
CC4575	elbow swivel c1 - 10x1.25mm p/	1	1.17	CC7400A	Assorted box release Tool Kit	1	1.17	MAB082	bulkhead 1/2bsp-m22 pkt1	1	1.27
CC4576	elbow swivel c1 - 10x1.5mm p/i	1	1.17	CC7406	release tool 6mm	1	1.15	MAB082	bulkhead 1/2bsp-m22 pkt1	1	2.11
CC4577	elbow swivel c1 - 12x1.5mm p/i	1	1.17	CC7406	release tool 6mm	1	1.17	MAB084	bulkhead m22x1.5-8mm	1	2.11
CC4578	elbow 45 degree - c1 - m16x1.5	1	1.17	CC7408	release tool 8mm	1	1.15	MAB085	bulkhead m16x1.5-10mm	1	2.11
CC4579	elbow swivel c1 - m12x1.5	1	1.17	CC7408	release tool 8mm	1	1.17	MAB086	bulkhead m22x1.5-10mm	1	2.11
CC4580	elbow swivel c1 - m16x1.5	1	1.17	CC7410	release tool 10mm	1	1.15	MAB087	bulkhead m22x1.5-12mm	1	2.11
CC4589	tee swivel centre c1 - m12x1.5	1	1.17	CC7410	release tool 10mm	1	1.17	MAB095	hex nipple m12x1.5-m16x1.5	2	2.6
CC4590	tee swivel centre c1 - m16x1.5	1	1.17	CC7412	release tool 12mm	1	1.15	MAB097	hex nipple m12x1.5-m22x1.5	2	2.6
CC4591	tee swivel on run c1 - m12x1.5	1	1.17	CC7412	release tool 12mm	1	1.17	MAB100	hex nipple m14x1.5-m22x1.5	2	2.6
CC4592	tee swivel on run c1 - m16x1.5	1	1.17	CC7415	release tool 15mm	1	1.15	MAB101	hex nipple m16x1.5-m16x1.5	2	2.6
CC4595	tee female m22x1.5	1	1.15	CC7415	release tool 15mm	1	1.17	MAB102	hex nipple m16x1.5-m22x1.5	2	2.6
CC4596	tee female m22x1.5 c/w bracket	1	1.15	CC7416	release tool 16mm	1	1.15	MAB103	hex nipple m18x1.5-m18x1.5	1	2.6
CC4615	straight swivel c1 - m10x1	1	1.17	CC7416	release tool 16mm	1	1.17	MAB104	hex nipple m18x1.5-m22x1.5	1	2.6
CC4616	straight swivel c1 - m12x1.5	1	1.17	CC7420	anti rotation ring 22mm hex	1	1.17	MAB105	hex nipple m22x1.5-m22x1.5	2	2.6
CC4617	straight swivel c1 - m14x1.5	1	1.17	HT003	double hosetail 1/4 id pkt2	2	3.14	MAB109	hex nipple 1/4npt-m16x1.5	2	2.6
CC4618	straight swivel c1 - m16x1.5	1	1.17	HT005	double hosetail 5/16 id pkt2	2	3.14	MAB110	hex nipple 3/8npt-m16x1.5	1	2.6
CC4619	straight swivel c1 - m22x1.5	1	1.17	HT007	double hosetail 3/8 id pkt2	2	3.14	MAB111	hex nipple 1/2npt-m22x1.5	1	2.6
CC6502	straight connector 6mm p/i	1	1.13	HT009	double hosetail 1/2 id pkt2	2	3.14	MAB114	hosetail m16x1.5-13mm	2	2.9
CC6504	straight connector 8mm p/i	1	1.13	HT015	hosetail 1/4bsp-1/2 id pkt2	2	3.14	MAB115	hosetail m22x1.5-13mm	2	2.9
CC6506	straight connector 10mmx1mm p/	1	1.13	HT016	hosetail 3/8bsp-1/4 id pkt2	2	3.14	MAB116	fixed hose tail	2	2.9
CC6506.25	straight connector 10x1.25 mm	1	1.13	HT017	hosetail 3/8bsp-5/16 id pkt2	2	3.14	MAB119	hosetail m16x1.5fen-13mm	2	2.9
CC6506.5	straight connector 10x1.5 mm p	1	1.13	HT018	hosetail 3/8bsp-3/8 id pkt2	2	3.14	MAB123	elbow stud m12x1.5-8mm	1	2.12
CC6508	straight connector 12mm p/i	1	1.13	HT019	hosetail 3/8bsp-1/2 id pkt2	2	3.14	MAB124	elbow stud m12x1.5-8mm	1	2.12
CC6509	straight connector 18mm p/i	1	1.13	HT020	hosetail 1/2bsp-3/8 id pkt2	2	3.14	MAB126	stud elbow 1/4npt - 10mm	1	2.12
CC6511	straight connector 15mm p/i	1	1.13	HT021	hosetail 1/2bsp-1/2 id pkt2	2	3.14	MAB127	elbow stud m12x1.5-10mm	1	2.12
CC6512	straight connector 16mm p/i	1	1.13	HT024	hosetail swivel 1/4npt-3/8 pk1	1	2.9	MAB128	elbow stud m14x1.5-10mm	1	2.12
CC6517	tee connector 6mm p/i	1	1.15	HT026	hosetail swivel m16-3/8 pk1	1	2.9	MAB129	elbow stud m16x1.5-10mm	1	2.12
CC6519	tee connector 8mm p/i	1	1.15	HT028	hosetail swivel m16-13mm	1	2.9	MAB130	elbow stud m22x1.5-10mm	1	2.12
CC6521	tee connector 10mm p/i	1	1.15	MAB001	straight conn 6mm pkt2	2	2.10	MAB131	elbow stud m16x1.5-12mm	1	2.12
CC6521.5	tee connector 10mm x1.5 p/i	1	1.15	MAB002	straight conn 8mm pkt2	2	2.10	MAB132	elbow stud m22x1.5-12mm	1	2.12
CC6523	tee connector 12mm p/i	1	1.15	MAB004	straight conn 10mm pkt2	2	2.10	MAB133	elbow stud m22x1.5-15mm	1	2.12
CC6529	tee connector 8mm-8mm-6mm	1	1.15	MAB006	straight conn 12mm pkt2	2	2.10	MAB135	elbow standpipe 8mm od	1	2.12
CC6532	tee connector 12mm-12mm-8mm	1	1.15	MAB009	straight conn 15mm pkt1	1	2.10	MAB136	elbow standpipe 10mm od	1	2.12
CC6533	elbow connector 6mm	1	1.13	MAB010	straight conn 16mm pkt1	1	2.10	MAB137	elbow standpipe 12mm od	1	2.12
CC6535	elbow connector 8mm	1	1.13	MAB011	straight conn 18mm pkt1	1	2.10	MAB144	elbow male/female m16x1.5	1	2.13
CC6537	elbow connector 10mm	1	1.13	MAB013	elbow conn 6mm pkt1	1	2.12	MAB145	elbow male/female m22x1.5	1	2.13
CC6539	elbow connector 12mm	1	1.13	MAB014	elbow conn 8mm pkt1	1	2.12	MAB147	tee side stem 8mm od pkt1	1	2.14
CC6602	elbow stud m12x1.5 - 6mm	1	1.14	MAB016	elbow conn 10mm pkt1	1	2.12	MAB148	tee side stem 10mm od pkt1	1	2.14
CC6603	elbow stud m16x1.5 - 6mm	1	1.14	MAB018	elbow conn 12mm pkt1	1	2.12	MAB149	tee side stem 12mm od pkt1	1	2.14
CC6604	elbow stud m12x1.5 - 8mm	1	1.14	MAB021	elbow conn 18mm pkt1	1	2.12	MAB151	tee branch stem 8mm od pkt1	1	2.13
CC6605	elbow stud m16x1.5 - 8mm	1	1.14	MAB022	tee conn 6mm pkt1	1	2.13	MAB152	tee branch stem 10mm pkt1	1	2.13
CC6606	elbow stud m22x1.5 - 8mm	1	1.14	MAB023	tee conn 8mm pkt1	1	2.13	MAB156	tee female m16x1.5 pkt1	1	2.14
CC6607	elbow stud m14x1.5 - 8mm	1	1.14	MAB025	tee conn 10mm pkt1	1	2.13	MAB157	test point 1/4npt pkt1	1	2.16
CC6610	elbow stud m12x1.5 - 10x1mm	1	1.14	MAB026	tee conn 12mm pkt1	1	2.13	MAB158	test point m12x1.5 pkt1	1	2.16
CC6610.25	elbow stud m12x1.5 - 10x1.25mm	1	1.14	MAB032	stud conn m10x1-6mm pkt3	3	2.10	MAB159	test point m16x1.5 pkt1	1	2.16
CC6610.5	elbow stud m12x1.5 - 10x1.5mm	1	1.14	MAB033	stud conn m12x1.5-6mm pkt2	2	2.10	MAB160	test point m22x1.5 pkt1	1	2.16
CC6613	elbow stud m16x1.5 - 10x1mm	1	1.14	MAB034	stud conn m10x1-8mm pkt2	2	2.10	MAB164	tee t/p m16x1.5-10mm pkt1	1	2.16
CC6613.25	elbow stud m16x1.5 - 10x1.25mm	1	1.14	MAB035	stud conn m12x1.5-8mm pkt2	2	2.10	MAB165	tee t/p m22x1.5-10mm pkt1	1	2.16
CC6613.5	elbow stud m16x1.5 - 10x1.5mm	1	1.14	MAB036	stud conn m14x1.5-8mm pkt2	2	2.10	MAB170	test point adaptor	1	2.16
CC6614	elbow stud m22x1.5 - 10x1mm	1	1.14	MAB037	stud conn m16x1.5-8mm pkt2	2	2.10	MAB171	test point adapt m16x1.5-3/8	1	2.16
CC6614.25	elbow stud m22x1.5 - 10x1.25mm	1	1.14	MAB038	stud conn m22x1.5-8mm pkt2	2	2.10	MAB172	test point adapt m16x1.5-1/4	1	2.16
CC6614.5	elbow stud m22x1.5 - 10x1.5mm	1	1.14	MAB044	stud conn 1/4npt-10mm pkt2	2	2.10	MAB173	test point m16 female pkt1	1	2.16
CC6619	elbow stud m16x1.5 - 12mm	1	1.14	MAB045	stud conn m10x1-10mm pkt2	2	2.10	MAL001	reducer bush 1/4-1/8 pkt3	3	2.6
CC6620	elbow stud m22x1.5 - 12mm	1	1.14	MAB046	stud conn m12x1.5-10mm	2	2.10	MAL001	reducer bush 1/4-1/8 pkt3	3	4.7
CC6625	elbow stud m16x1.5 - 16mm	1	1.14	MAB047	stud conn m14x1.5-10mm	2	2.10	MAL002	reducer bush 3/8 x 1/4 pkt 3	3	2.6
CC6626	elbow stud m22x1.5 - 16mm	1	1.14	MAB048	stud conn m16x1.5-10mm	2	2.10	MAL002	reducer bush 3/8 x 1/4 pkt 3	3	4.7
CC6638	tee stud m16x1.5 - 10x1mm	1	1.13	MAB049	stud conn m22x1.5-10mm	2	2.10	MAL003	reducer bush 1/2-1/4 pkt3	3	2.6
CC6638.5	tee stud m16x1.5 - 10x1.5	1	1.13	MAB055	stud conn 1/4npt-12mm pkt1	1	2.10	MAL003	reducer bush 1/2-1/4 pkt3	3	4.7
CC6639	tee stud m22x1.5 - 10x1m	1	1.13	MAB056	stud conn m12x1.5-12mm pkt2	2	2.10	MAL004	reducer bush 1/2-3/8 pkt3	3	2.6
CC6639.5	tee stud m22x1.5 - 10x1.5m	1	1.13	MAB057	stud conn m14x1.5-12mm pkt2	2	2.10	MAL004	reducer bush 1/2-3/8 pkt3	3	4.7

Part No.	Description	Qty	Page	Part No.	Description	Qty	Page	Part No.	Description	Qty	Page
MAL006	reducer bush 3/4-1/2 pkt1	1	2.6	PIF061	straight conn 3/8 pkt2	2	3.9	PIF394	straight stud m22x1.5-15mm	1	1.30
MAL006	reducer bush 3/4-1/2 pkt1	1	4.7	PIF062	straight conn 1/2 pkt1	1	3.9	PIF395	straight stud m16x1.5-16mm	1	1.30
MAL007	female socket 1/8bsp pkt3	3	4.7	PIF073	tee conn 1/4 pkt2	2	3.9	PIF396	straight stud m22x1.5-16mm	1	1.30
MAL008	female socket 1/4bsp pkt3	3	4.7	PIF075	tee conn 3/8 pkt1	1	3.9	PIF402	elbow stud m12x1.5-6mm pkt1	1	1.30
MAL009	female socket 3/8bsp pkt3	3	4.7	PIF076	tee conn 1/2 pkt1	1	3.9	PIF404	elbow stud m12x1.5-8mm pkt1	1	1.30
MAL010	female socket 1/2bsp pkt3	3	4.7	PIF106	tube cutter pkt1	1	6.7	PIF405	elbow stud m16x1.5-8mm pkt1	1	1.30
MAL012	hex nipple 1/8bsp pkt3	3	4.7	PIF106	tube cutter pkt1	1	8.11	PIF406	elbow stud m22x1.5-8mm pkt1	1	1.30
MAL013	hex nipple 1/4bsp pkt3	3	4.7	PIF130	stem reducer 6mm-4mm pkt3	3	3.7	PIF410	elbow stud m12x1.5-10mm pkt1	1	1.30
MAL014	hex nipple 3/8bsp pkt2	2	4.7	PIF132	stem reducer 8mm-6mm pkt3	3	3.7	PIF413	elbow stud m16x1.5-10mm pkt1	1	1.30
MAL015	hex nipple 1/2bsp pkt3	3	4.7	PIF134	stem reducer 10mm-8mm pkt2	2	3.7	PIF414	elbow stud m22x1.5-10mm pkt1	1	1.30
MAL017	plug 1/8bsp pkt3	3	4.7	PIF136	stem reducer 12mm-8mm pkt2	2	3.7	PIF419	elbow stud m16x1.5-12mm pkt1	1	1.30
MAL018	plug 1/4bsp pkt5	5	4.7	PIF138	stem reducer 12mm-10mm pkt1	1	3.7	PIF420	elbow stud m22x1.5-12mm pkt1	1	1.30
MAL019	plug 3/8bsp pkt4	4	4.7	PIF147	straight conn 8mm-6mm pk2	2	3.7	PIF425	elbow stud m16x1.5-16mm pkt1	1	1.30
MAL020	plug 1/2bsp pkt3	3	4.7	PIF148	straight conn 6mm-4mm pkt 2	2	3.7	PIF426	elbow stud m22x1.5-16mm pkt1	1	1.30
MAL024	tee female 1/4bsp pkt2	2	4.7	PIF149	straight conn 10mm-6mm pkt 2	2	3.7	PIF438	tee stud m16x1.5-10mm pkt1	1	1.29
MAL026	tee female 1/2bsp pkt1	1	4.7	PIF150	straight conn 10mm-8mm pkt 2	2	3.7	PIF439	tee stud m22x1.5-10mm pkt1	1	1.29
MAL028	elbow female 1/4bsp pkt3	3	4.7	PIF186	elbow swivel 1/8bsp-4mm pkt 2	2	3.5	PIF444	tee stud m16x1.5-12mm pkt1	1	1.29
MAL030	elbow female 1/2bsp pkt2	2	4.7	PIF186	elbow swivel 1/8bsp-4mm pkt 2	2	3.7	PIF445	tee stud m22x1.5-12mm pkt1	1	1.29
MAL033	elbow male/female 3/8bsp pkt2	2	4.7	PIF194	elbow swivel 8mm-1/4bsp pkt1	1	3.5	PIF465	straight conn 1/4 pkt2	2	1.32
MAL034	elbow male/female 1/2bsp pkt2	2	4.7	PIF197	y conn 6mm pkt1	1	3.5	PIF467	straight conn 3/8 pkt 1	1	1.32
MAL042	hex nipple 1/4-1/2 pkt 2	2	4.8	PIF198	y conn 8mm pkt1	1	3.5	PIF501	straight stud 1/8bsp-1/4 pkt2	2	1.32
MAL043	hex nipple 3/8-1/2 pkt 2	2	4.8	PIF199	y conn 10mm pkt1	1	3.5	PIF504	straight stud 1/4bsp-3/16 pkt1	1	3.4
MSK240	assorted box plastic push in	1	3.5	PIF201	plug 6mm mod pk3	3	3.7	PIF505	straight stud 1/4bsp-1/4 pkt1	1	1.32
MSK300	assorted box brass olives	1	4.4	PIF203	plug 10mm mod pk2	2	3.7	PIF507	straight stud 1/4bsp-3/8 pkt1	1	1.32
MSK330	assorted box brass compression	1	4.4	PIF204	plug 12mm mod pk2	2	3.7	PIF512	straight stud 3/8bsp-3/8 pkt1	1	1.32
MSK470	assorted box voss 230 range	1	1.35	PIF300	straight conn 4mm pkt 2	2	3.2	PIF519	elbow swivel 1/8bsp-1/4 pkt 1	1	3.4
MSK475	assorted box voss 232 range	1	1.37	PIF301	straight conn 5mm pkt 2	2	3.2	PIF520	elbow swivel 1/8bsp-1/4 pkt1	1	1.32
MSK650	assorted box norgren push in	1	1.31	PIF302	straight conn 6mm pkt 2	2	1.29	PIF523	elbow stud 1/4bsp-1/4 pkt1	1	1.32
MSK703	assorted box wira push in range	1	1.21	PIF304	straight conn 8mm pkt 1	1	1.29	PIF526	elbow stud 1/4bsp-3/8 pkt1	1	1.32
MSK760	assorted box thread adaptors	1	2.7	PIF305	straight conn 9mm pkt1	1	1.29	PIF527	elbow stud 1/4bsp-1/2 pkt1	1	1.32
MSK764	assorted box sealing rings	1	2.4	PIF306	straight conn 10mm pkt 1	1	1.29	PIF529	elbow stud 3/8bsp-3/8 pkt1	1	1.32
MSK770	assorted box wira compression	1	2.11	PIF307	straight conn 11mm pkt1	1	1.29	PIF531	elbow stud 1/2bsp-1/2 pkt 1	1	1.32
MSK802	assorted box raufoss newline	1	1.4	PIF308	straight conn 12mm pkt 1	1	1.29	PIF555	straight stud 1/8bsp-6mm pkt1	1	1.31
MSK805	assorted box raufoss newline	1	1.4	PIF310	straight conn 14mm pkt1	1	1.29	PIF556	straight stud 1/8bsp-8mm pkt1	1	1.31
MSK811	assorted box emergency repair kit	1	1.15	PIF311	straight conn 15mm pkt 1	1	1.29	PIF557	straight stud 1/8bsp-4mm pkt2	2	3.2
MSK812	assorted box camozzi c1 range	1	1.17	PIF312	straight conn 16mm pkt 1	1	1.29	PIF559	straight stud 1/4bsp-6mm pk1	1	1.31
MSK813	assorted box camozzi c truck	1	1.15	PIF315	push in tee 4mm pkt 1	1	3.2	PIF560	straight stud 1/4bsp-8mm pkt1	1	1.31
MSK820	assorted box raufoss newline	1	1.4	PIF317	push in tee 6mm pkt 1	1	1.29	PIF561	straight stud 1/8bsp-10mm pk1	1	1.31
MSK830	assorted box camozzi	1	1.15	PIF319	push in tee 8mm pkt 1	1	1.29	PIF562	straight stud 1/4bsp-10mm pk1	1	1.31
PIF001	straight conn 4mm pkt3	3	3.5	PIF321	push in tee 10mm pkt 1	1	1.29	PIF563	straight stud 1/4bsp-12mm pk1	1	1.31
PIF002	straight conn 5mm pkt 3	3	3.5	PIF323	push in tee 12mm pkt 1	1	1.29	PIF564	straight stud 3/8bsp-10mm pk1	1	1.31
PIF003	straight conn 6mm pkt3	3	3.5	PIF327	push in tee 16mm pkt 1	1	1.29	PIF566	straight stud 3/8bsp-12mm pk1	1	1.31
PIF004	straight conn 8mm pkt2	2	3.5	PIF331	push in elbow 4mm pkt 2	2	3.2	PIF567	straight stud 1/2bsp-10mm pk1	1	1.31
PIF006	straight conn 10mm pkt2	2	3.5	PIF333	push in elbow 6mm pkt 1	1	1.29	PIF568	straight stud 1/2bsp-12mm pk1	1	1.31
PIF008	straight conn 12mm pkt2	2	3.5	PIF335	push in elbow 8mm pkt 1	1	1.29	PIF572	straight stud m16x1.5-1/4 pkt1	1	1.33
PIF010	straight conn 15mm pkt1	1	3.6	PIF337	push in elbow 10mm pkt 1	1	1.29	PIF573	straight stud m16x1.5-3/8 pkt1	1	1.33
PIF011	elbow conn 4mm pkt2	2	3.5	PIF339	push in elbow 12mm pkt 1	1	1.29	PIF575	straight stud m16x1.5-1/2 pkt1	1	1.33
PIF012	elbow conn 5mm pkt2	2	3.6	PIF343	push in elbow 16mm pkt 1	1	1.29	PIF584	elbow swivel 1/8bsp-4mm pkt2	2	3.2
PIF013	elbow conn 6mm pkt2	2	3.5	PIF364	straight stud m10x1-6mm pkt1	1	1.30	PIF585	elbow swivel 1/8bsp-5mm pkt2	2	3.2
PIF014	elbow conn 8mm pkt2	2	3.5	PIF365	straight stud m12x1.5-6mm pkt1	1	1.30	PIF586	elbow stud 1/8bsp-6mm pkt1	1	1.30
PIF016	elbow conn 10mm pkt2	2	3.5	PIF366	straight stud m14x1.5-6mm pkt1	1	1.30	PIF587	elbow stud 1/8bsp-8mm pkt1	1	1.30
PIF018	elbow conn 12mm pkt1	1	3.5	PIF367	straight stud m16x1.5-6mm pkt1	1	1.30	PIF588	elbow stud 1/4bsp-4mm pkt2	2	3.2
PIF020	elbow conn 15mm pkt1	1	3.6	PIF368	straight stud m22x1.5-6mm pkt1	1	1.30	PIF590	elbow stud 1/4bsp-6mm pkt1	1	1.30
PIF021	tee conn 4mm pkt2	2	3.5	PIF369	straight stud m10x1-8mm pkt1	1	1.30	PIF591	elbow stud 1/4bsp-8mm pkt1	1	1.30
PIF022	tee conn 5mm pkt2	2	3.5	PIF370	straight stud m12x1.5-8mm pkt1	1	1.30	PIF592	elbow stud 1/4bsp-10mm pkt1	1	1.30
PIF023	tee conn 6mm pkt2	2	3.5	PIF371	straight stud m14x1.5-8mm pkt1	1	1.30	PIF599	elbow stud 3/8bsp-10mm pkt1	1	1.30
PIF024	tee conn 8mm pkt2	2	3.5	PIF372	straight stud m16x1.5-8mm pkt1	1	1.30	PIF601	elbow stud 3/8bsp-12mm pkt1	1	1.30
PIF026	tee conn 10mm pkt1	1	3.5	PIF373	straight stud m22x1.5-8mm pkt1	1	1.30	PIF605	elbow stud 1/2bsp-10mm pkt1	1	1.30
PIF028	tee conn 12mm pkt1	1	3.5	PIF376	straight stud m10x1-10mm pkt1	1	1.30	PIF613	bulkhead conn m22x1.5-10mm	1	1.29
PIF030	tee conn 15mm pkt1	1	3.6	PIF377	straight stud m12x1.5-10mm	1	1.30	PIF616	bulkhead conn m22x1.5-12mm	1	1.29
PIF031	straight stud 1/8bsp-4mm pkt3	3	3.5	PIF378	straight stud m14x1.5-10mm	1	1.30	PIF803	straight conn 6mm pkt2	2	3.2
PIF033	straight stud 1/4bsp-6mm pkt3	3	3.5	PIF379	straight stud m16x1.5-10mm	1	1.30	PIF804	straight conn 8mm pkt2	2	3.2
PIF034	straight stud 1/4bsp-8mm pkt3	3	3.5	PIF380	straight stud m22x1.5-10mm	1	1.30	PIF805	straight conn 10mm pkt1	1	3.2
PIF036	straight stud 1/4bsp-10mm pkt2	2	3.5	PIF384	straight stud m12x1.5-12mm	1	1.30	PIF806	straight conn 12mm pkt1	1	3.2
PIF057	straight conn 5/32 pkt3	3	3.9	PIF385	straight stud m14x1.5-12mm	1	1.30	PIF813	tee conn 8mm pkt1	1	3.2
PIF058	straight conn 3/16 pkt3	3	3.9	PIF386	straight stud m16x1.5-12mm	1	1.30	PIF814	tee conn 10mm pkt1	1	3.2
PIF059	straight conn 1/4 pkt2	2	3.9	PIF387	straight stud m22x1.5-12mm	1	1.30	PIF834	straight stud 1/8bsp-6mm pkt2	2	3.2

Part No.	Description	Qty	Page	Part No.	Description	Qty	Page	Part No.	Description	Qty	Page
PIF835	straight stud 1/4bsp-6mm	2	3.2	R02031500	threadless coupling 15x1.5mm lrg	1	1.7	R10032200	swivel stud m22x1.5 lrg	1	1.5
PIF836	straight stud 1/8bsp-8mm	2	3.2	R02031600	threadless coupling 16x2 large	1	1.7	R10039530	swivel stud 3/8npt lrg	1	1.5
PIF837	straight stud 1/4bsp-8mm	2	3.2	R03000600	Elbow connector 6 x 1mm	1	1.8	R12000000	inline adaptor - fem - medium	1	1.8
PIF840	straight stud 1/8bsp-10mm	2	2	R03000800	Elbow connector 8 x 1mm	1	1.8	R14021622	bulkhead swi m22x1.5-m16 m/f	1	1.6
PIF841	straight stud 1/4bsp-10mm	1	3.2	R030010001	Elbow connector 10 x 1mm	1	1.8	R15020018	bulkhead swivel m18x1.5 med	1	1.6
PIF852	elbow swivel 1/4bsp-5mm	1	3.2	R030010002	Elbow connector 10 x 1.25mm	1	1.8	R17021622	bulkhead swivel m16x1.5-m22	1	1.6
PIF853	elbow swivel 1/8bsp-6mm	2	3.2	R030010005	Elbow connector 10 x 1.5mm	1	1.8	R17022222	bulkhead swivel m22x1.5 med	1	1.6
PIF854	elbow swivel 1/4bsp-6mm	2	3.2	R03001200	Elbow connector 12 x 1.5mm	1	1.8	R21000000	elbow 45 deg small body	1	1.9
PIF855	elbow swivel 3/8bsp-6mm	1	3.2	R03010600	integral elbow 6x1mm small	1	1.7	R22000000	elbow 45 deg medium body	1	1.9
PIF856	elbow swivel 1/8bsp-8mm	1	3.2	R03010800	integral elbow 8x1mm small	1	1.7	R32000000	elbow body med	1	1.9
PIF857	elbow swivel 1/4bsp-8mm	1	3.2	R03020600	integral elbow 6x1mm med	1	1.7	R33000000	elbow body large	1	1.9
PIF858	elbow swivel 3/8bsp-8mm	1	3.2	R03020610	stud elbow adpt 6 x 1 - m10x1	1	1.6	R42000000	f coupling body med	1	1.8
PIF860	elbow swivel 1/8bsp-10mm	1	3.2	R03020612	stud elbow adpt 6 x 1 - m12x1.5	1	1.6	R43000000	f coupling body large	1	1.8
PIF861	elbow swivel 1/4bsp-10mm	1	3.2	R03020616	stud elbow adpt 6 x 1 - m16x1.5	1	1.6	R51000000	tee coupling body small	1	1.9
R01041000	M Stud Con M10x1.5-4x1	1	1.5	R03020622	stud elbow adpt 6 x 1 - m22x1.5	1	1.6	R52000000	tee coupling body med	1	1.9
R01041200	M Stud Con M12x1.5-4x1	1	1.5	R03020800	integral elbow 8x1mm med	1	1.7	R52000600	Tee connector 6 x 1mm	1	1.8
R01061000	straight stud m10x1.5-6x1	1	1.5	R03020810	stud elbow adpt 8 x 1 - m10x1	1	1.6	R52000800	Tee connector 8 x 1mm	1	1.8
R01061200	straight stud m12x1.5-6x1	1	1.5	R03020812	stud elbow adpt 8 x 1 - m12x1.5	1	1.6	R520010001	Tee connector 10 x 1mm	1	1.8
R01061400	straight stud m14x1.5-6x1	1	1.5	R03020814	stud elbow adpt 8 x 1 - m14x1.5	1	1.6	R520010002	Tee connector 10 x 1.25mm	1	1.8
R01061600	straight stud m16x1.5-6x1	1	1.5	R03020816	stud elbow adpt 8 x 1 - m16x1.5	1	1.6	R520010005	Tee connector 10 x 1.5mm	1	1.8
R01062200	straight stud m22x1.5-6x1	1	1.5	R03020822	stud elbow adpt 8 x 1 - m22x1.5	1	1.6	R52001200	Tee connector 12 x 1.5mm	1	1.8
R01081000	straight stud m10x1.5-8x1	1	1.5	R03021001	integral elbow 10x1mm med	1	1.7	R53000000	tee body large	1	1.9
R01081200	straight stud m12x1.5-8x1	1	1.5	R03021002	integral elbow 10x1.25mm med	1	1.7	R53001500	Tee connector 15 x 1.5mm	1	1.8
R01081400	straight stud m14x1.5-8x1	1	1.5	R03021005	integral elbow 10x1.5mm med	1	1.7	R53001600	Tee connector 16 x 2mm	1	1.8
R01081600	straight stud m16x1.5-8x1	1	1.5	R030210101	stud elbow adpt 10 x 1 - m10x1	1	1.6	R60020000	threadless test point med	1	1.9
R01082200	straight stud m22x1.5-8x1	1	1.5	R030210102	stud elbow adpt 10 x 1.25 - m10x1	1	1.6	R61000000	y connector body small	1	1.8
R01101001	straight stud m10x1.5-10x1	1	1.5	R030210105	stud elbow adpt 10 x 1.5 - m10x1	1	1.6	R62000000	y connector body med	1	1.8
R01101003	straight stud m10x1.5-10x1.5	1	1.5	R030210121	stud elbow adpt 10 x 1 - m12x1.5	1	1.6	R64012200	rotaloc small 22mm hex	1	1.9
R01101201	straight stud m12x1.5-10x1	1	1.5	R030210122	stud elbow adpt 10x1.25-m12x1.5	1	1.6	R64021800	rotaloc regular 18mm	1	1.9
R01101202	stud m12x1.5-10x1.25	1	1.5	R030210125	stud elbow adpt 10x1.5 - m12x1.5	1	1.6	R64022200	rotaloc medium 22mm hex	1	1.9
R01101203	straight stud m12x1.5-10x1.5	1	1.5	R030210141	stud elbow adpt 10 x 1 - m14x1.5	1	1.6	R64022800	rotaloc medium 28mm hex	1	1.9
R01101401	straight stud m14x1.5-10x1	1	1.5	R030210142	stud elbow adpt 10x1.25-m14x1.5	1	1.6	R64032800	rotaloc large 28mm hex	1	1.9
R01101402	stud m14x1.5-10x1.25	1	1.5	R030210145	stud elbow adpt 10x1.5 - m14x1.5	1	1.6	R65020200	threadless adaptor med med	1	1.9
R01101403	straight stud m14x1.5-10x1.5	1	1.5	R030210161	stud elbow adpt 10 x 1 - m16x1.5	1	1.6	R65020300	threadless adaptor med lrg	1	1.9
R01101601	straight stud m16x.5-10x1	1	1.5	R030210162	stud elbow adpt 10x1.25-m16x1.5	1	1.6	R66021000	female swivel stud m10x1.5 reg	1	1.7
R01101602	stud m16x1.5-10x1.25	1	1.5	R030210165	stud elbow adpt 10 x 1.5-m16x1.5	1	1.6	R66021200	female swivel stud m12x1.5 reg	1	1.7
R01101603	straight stud m16x1.5-10x1.5	1	1.5	R030210221	stud elbow adpt 10 x 1 - m22x1.5	1	1.6	R66021600	female swivel stud m16x1.5 reg	1	1.7
R01102201	straight stud m22x1.5-10x1	1	1.5	R030210222	stud elbow adpt 10x1.25-m22x1.5	1	1.6	R66022200	female swivel stud m22x1.5 reg	1	1.7
R01102202	stud m22x1.5-10x1.25	1	1.5	R030210225	stud elbow adpt 10 x 1.5-m22x1.5	1	1.6	R68020000	threadless plug reg	1	1.7
R01102203	straight stud m22x1.5-10x1.5	1	1.5	R03021200	integral elbow 12x1.5mm med	1	1.7	R72000000	3 way conn body med	1	1.8
R01121000	straight stud m10x1.5-12x1.5	1	1.5	R03021210	stud elbow adpt 12 x 1.5 - m10x1	1	1.6	R75020300	Threadless Reducer large - reg	1	1.9
R01121200	stud m12x1.5-12x1.25	1	1.5	R03021212	stud elbow adpt 12x1.5 - m12x1.5	1	1.6	R82000000	cross coupling body med	1	1.8
R01121400	straight stud m14x1.5-12x1.5	1	1.5	R03021216	stud elbow adpt 12x1.5 - m16x1.5	1	1.6	R83000000	cross coupling body large	1	1.8
R01121600	straight stud m16x1.5-12x1.5	1	1.5	R03021222	stud elbow adpt 12x1.5 - m22x1.5	1	1.6	R92000000	4 way block medium body	1	1.8
R01122200	straight stud m22x1.5-12x1.5	1	1.5	R03021522	stud elbow adpt 15x1.5 - m22x1.5	1	1.6	R93000000	4 way block large body	1	1.8
R01126350	straight stud m12x1.5-1/4	1	1.5	R03021616	stud elbow adpt 16x2 - m16x1.5	1	1.6	R99000000	assorted box tube release tools	1	1.4
R01127160	straight stud m16x1.5-1/2npt	1	1.5	R03021622	stud elbow adpt 16 x 2 - m22x1.5	1	1.6	R99060200	tube release tool pro 6x1mm	1	1.4
R01151400	straight stud m14x1.5-15x1.5	1	1.5	R03031500	integral elbow 15x1.5mm lrg	1	1.7	R99080200	tube release tool pro 8mm	1	1.4
R01151600	straight stud m16x1.5-15x1.5	1	1.5	R03031600	integral elbow 16x2mm lrg	1	1.7	R99100200	tube release tool pro 10mm	1	1.4
R01152200	straight stud m22x1.5-15x1.5	1	1.5	R040106	medium plugg 6mm	1	1.9	R99120200	tube release tool pro 12mm	1	1.4
R01152600	straight stud m26x1.5-15x1.5	1	1.5	R040108	medium plugg 8mm	1	1.9	R99150200	tube release tool pro 15mm	1	1.4
R01159160	straight stud m16x1.5-5/8npt	1	1.5	R040112	medium plugg 12mm	1	1.9	R99160200	tube release tool pro 16mm	1	1.4
R01161200	straight stud m12x1.5-16x2	1	1.5	R10011200	swivel stud m12x1.5 small	1	1.5	RA499	bulkhead m22x1.5-m16x1.5 m/f	1	1.10
R01161600	straight stud m16x1.5-16x2	1	1.5	R10011600	swivel stud m16x1.5 small	1	1.5	RA581	elbow female m12x1.5 pkt1	1	1.11
R01162200	straight stud m22x1.5-16x2	1	1.5	R10013175	swivel stud 1/8npt small	1	1.5	RA582	elbow female m16x1.5 pkt1	1	1.11
R01635160	straight stud m16x1.5-1/4npt	1	1.5	R10016350	swivel stud 1/4npt small	1	1.5	RA583	elbow female m22x1.5 pkt1	1	1.11
R01953160	straight stud m16x1.5-3/8npt	1	1.5	R10021000	swivel stud m10x1 med	1	1.5	RA584	elbow m/f m12x1.5 pkt1	1	1.11
R02010800	threadless coupling 8x1 small	1	1.7	R10021200	swivel stud m12x1.5 med	1	1.5	RA585	elbow m/f m16x1.5 pkt1	1	1.11
R02020400	Threadless coupling reg - 4x1	1	1.7	R10021270	swivel stud 1/2npt med	1	1.5	RA586	elbow m22x1.5-m16x1.5 m/f	1	1.11
R02020600	threadless coupling 6x1 med	1	1.7	R10021400	swivel stud m14x1.5 med	1	1.5	RA587	elbow m/f m16x1.5 c/w l/n+o/r	1	1.11
R02020800	threadless coupling 8x1 med	1	1.7	R10021600	swivel stud m16x1.5 med	1	1.5	RA588	elbow m/f m22x1.5 c/w l/n+o/r	1	1.11
R02021001	threadless coup 10x1 med	1	1.7	R10022200	swivel stud m22x1.5 med	1	1.5	RA593	tee female m12x1.5 pkt1	1	1.11
R02021002	threadless coup 10x1.25 med	1	1.7	R10023175	swivel stud 1/8npt med	1	1.5	RA594	tee female m16x1.5 pkt1	1	1.11
R02021003	threadless coup 10x1.5 med	1	1.7	R10026350	swivel stud 1/4npt med	1	1.5	RA595	tee female m22x1.5 pkt1	1	1.11
R02021200	threadless coup 12x1.5 med	1	1.7	R10029530	swivel stud 3/8npt med	1	1.5	RA596	tee female m16x1.5	1	1.11
R02031200	threadless coup 12x1.5 large	1	1.7	R10031270	swivel stud 1/2npt lrg	1	1.5	RA604	adaptor m/f m16x1.5-m12x1.5	1	2.7
R02031400	threadless coup 14x2 large	1	1.7	R10031600	swivel large m16x1.5	1	1.5	RA606	adaptor m/f m22x1.5-m16x1.5	1	2.7

Part No.	Description	Qty	Page	Part No.	Description	Qty	Page	Part No.	Description	Qty	Page
RA608	adaptor m/f m16x1.5-1/4nptf pkt1	1	2.7	V235006	door retainerezinc plated l/h	1	10.6	VAL645	3/2 lever spring valve g1/8	1	9.6
RA610	adaptor m/f 1/4npt-m12x1.5 pkt1	1	2.7	V240001	rubber buffer 345mmx100x108	1	10.9	VAL646	3/2 solenoid valve	1	9.11
RA611	adaptor m/f 1/4npt-m16x1.5 pkt1	1	2.7	V240002	rubber buffer 240mmx80x90	1	10.9	VAL647	3/2 pilot spring valve g1/4 4 bar	1	9.3
RA613	bulkhead conn m16 - m18x1.5	1	1.10	V240003	rubber buffer 195mmx80x80	1	10.9	VAL648	non return valve 8mmod	1	9.17
RA630	bulkhead male/fem m16-m22x1.5	1	1.10	V240005	rubber buffer 210mmx50x58	1	10.9	VAL652	coil assembly 24v dc	1	9.21
RA631	bulkhead m16x1.5-m16-m22 In&o	1	1.10	V240010	uni-roll rubber twin roller	1	10.8	VAL654	12mm non return valve	1	9.18
RA700	straight stud m12x1.5-6x1mm	1	1.5	V240012	rubber roller	1	10.8	VAL655	3/2 pilot spring valve g1/4 2 bar	1	9.3
RA701	straight stud m14x1.5-6x1mm	1	1.5	V31008	clevis pin 1/2in pkt10	10	10.10	VAL656	non-return valve 10mm o/d	1	9.17
RA702	straight stud m16x1.5-6x1mm	1	1.5	V31107	clevis fork m16-1/2in pin	1	10.10	VAL657	pressure regulator g1/4	1	9.17
RA704	straight stud m22x1.5-6x1mm	1	1.5	V31109	clevis fork m16-14mm pin	1	10.10	VAL657B	bracket to suit val657	1	9.21
RA705	straight stud m10x1.5-8x1mm pk1	1	1.5	V31113	clevis pin 14mm pkt10	10	10.10	VAL659	3/2 solenoid spring valve volvo	1	9.11
RA706	straight stud m12x1.5-8x1mm	1	1.5	V31276	clevis fork m16 x 1.5 14mm pin	1	10.10	VAL660	connector with lead	1	9.11
RA707	straight stud m14x1.5-8x1mm pk1	1	1.5	V31306	clevis pin 16mm	1	10.10	VAL665	3/2 roller spring valve	1	9.9
RA708	straight stud m16x1.5-8x1mm	1	1.5	V31329	clevis fork m16 x 1.5 16mm pin	1	10.10	VAL666	3/2 roller lever spring valve g1/4	1	9.8
RA709	straight stud m22x1.5-8x1mm	1	1.5	V31367	clevis pin 10mm	1	10.10	VAL668	3/2 solenoid/spring valve g1/4	1	9.10
RA710	straight stud m12x1.5-10x1.25mm	1	1.5	V51001	wire rope grip pkt20	20	10.11	VAL671	plastic porous silencer 3/8"	1	9.20
RA712	straight stud m16x1.5-10x1.25mm	1	1.5	V51157	steel cable 1.5mm dia 50mtr reel	50m	10.11	VAL672	3/2 button spring valve g1/8	1	9.4
RA714	straight stud m22x1.5-10x1.25mm	1	1.5	V51319	steel cable 3mm dia 30mtr coil	30m	10.11	VAL673	5/3 lever lever valve g1/4	1	9.14
RA715	straight stud m12x1.5-12x1.25mm	1	1.5	V61098	wheel nut r/h 7/8bsf	1	10.9	VAL674	5/32 lever spring lever val g1/4	1	9.15
RA716	straight stud m16x1.5-12x1.5mm	1	1.5	V61099	wheel nut l/h 7/8bsf	1	10.9	VAL675	1/4npt bronze silencer	1	9.19
RA717	straight stud m16x1.5-16x2mm	1	1.5	V61143	wheel nut - 26mm deep	1	10.9	VAL677	3/2 antenna spring valve g1/8	1	9.9
RA718	straight stud m22x1.5-12x1.5mm	1	1.5	V71129	springhook 9 link chain 75mm	1	10.5	VAL678	5/2 push/pull or pilot valve g1/8	1	9.13
RA720	straight stud m22x1.5-15x1.5mm	1	1.5	V71132	springhook 14 link chain 102mm	1	10.5	VAL679	trailer park valve m16	1	9.19
RA722	straight stud m22x1.5-16x2mm	1	1.5	V71634	cable retainer clear	1	10.6	VAL680	3/2 button spring val black g1/8	1	9.5
RA723	straight stud m12x1.5-10x1mm	1	1.5	V73025A	stayfast latch 25mm lg c/w nut/was	1	10.5	VAL681B	3/2 solenoid/pilot valve g1/4	1	9.10
RA724	straight stud m12x1.5-10x1.5mm	1	1.5	V73034A	stayfast latch 34mm lg c/w nut/was	1	10.5	VAL682	3/2 solenoid air spring val g1/8	1	9.10
RA725	straight stud m16x1.5-10x1mm pk1	1	1.5	V73038	stayfast latch 38mm/m8x1.25mm	1	10.5	VAL684	5/2 lever/lever valve g1/4	1	9.14
RA726	straight stud m16x1.5-10x1.5mm	1	1.5	V73076A	stayfast latch 76mm lg m12x1.5	1	10.5	VAL685	coil assembly 24v dc	1	9.19
RA727	straight stud m22x1.5-10x1mm	1	1.5	V81028	winding handle slotted end 495mm	1	10.11	VAL687	plug 22mm industrial standard	1	9.19
RA728	straight stud m22x1.5-10x1.5mm	1	1.5	VAL601	3/2 roller lever/spring h/d g1/8	1	9.7	VAL690	pressure regulator (relieving)	1	9.16
RA731	threadless coupling 6x1mm med	1	1.7	VAL602	3/2 push/pull black handle g1/8	1	9.6	VAL691	3/2 pilot spring nc valve g1/8	1	9.3
RA733	threadless coupling 8x1mm med	1	1.7	VAL603	3/2 pilot/spring valve g1/8	1	9.3	VAL696	5/2 pilot spring valve g1/4	1	9.11
RA734	threadless coupling 10x1.25 med	1	1.7	VAL604	3/2 pilot/spring valve g1/4 2 bar	1	9.2	VAL697	5/2 pilot spring valve	1	9.12
RA735	threadless coupling 12x1.5 med	1	1.7	VAL605	3/2 pilot/spring valve m14	1	9.2	VAL698	pilot blocking valve 8mm	1	9.13
RA741	integral elbow 6x1mm med pkt1	1	1.7	VAL606	3/2 pilot/spring valve m14	1	9.2	VAL700	non return valve m22 m/f	1	9.18
RA743	integral elbow 8x1mm med pkt1	1	1.7	VAL608	5/2 push/pull valve black han g1/4	1	9.13	VAL702	exhaust guard 1/2" bsp/npt	1	9.20
RA744	integral elbow 10x1.25mm med	1	1.7	VAL609	5/2 solenoid spring valve	1	9.15	VAL704	filter/regulator	1	9.21
RA745	integral elbow 12x1.5mm med	1	1.7	VAL610	5/2 push/pull valve black han g1/8	1	9.12	VAL712	pressure gauge 10 bar	1	9.20
RA750	elbow body med pkt1	1	1.9	VAL611	5/2 toggle/toggle valve g1/8	1	9.14	VAL718	3/2 solenoid spring valve volvo	1	9.11
RA752	elbow 45deg body med pkt1	1	1.9	VAL612	3/2 roller lever spring valve	1	9.8	VAL719	operating head	1	9.19
RA754	tee coupling body med pkt1	1	1.9	VAL613	rota wink off black/on red	1	9.16	VAL722	3/2 lever spring valve g1/4	1	9.6
RA756	threadless adaptor med med pkt1	1	1.9	VAL614	3/2 black button/spring valve	1	9.5	VAL731	in-line flow regulator 6mm od	1	9.18
RA760	threadless test point pkt1	1	1.9	VAL615	3/2 solenoid/spring valve m14	1	9.9	VAL733	in-line flow regulator	1	9.18
RA762	tube release tool 6mm pkt1	1	1.4	VAL616	3/2 red button/spring valve g1/8	1	9.5	VAL800	Emergency Valve Kit	1	9.21
RA763	tube release tool 8mm pkt1	1	1.4	VAL617	3/2 green button/spring valve g1/8	1	9.5	VAL801	3/2 pilot/spring valve g1/8 0.9	1	9.2
RA764	tube release tool 10mm pkt1	1	1.4	VAL618	rotowink off red/on green	1	9.15	VAL804	3/2 pilot/spring valve g1/4 0.9	1	9.2
RA765	tube release tool 12mm pkt1	1	1.4	VAL619	rotowink off green/on red	1	9.15	VAL810	5/2 push/pull valve black g1/8	1	9.12
RA766	tube release tool 15mm pkt1	1	1.4	VAL620	pilot blocking valve 6mm	1	9.18	VAL811	5/2 toggle/toggle valve g1/8	1	9.14
RA767	tube release tool 16mm pkt1	1	1.4	VAL621	plastic silencer porous 1/2"npt	1	9.20	VAL812	3/2 roller lever spring valve	1	9.8
RA772	swivel stud m10x1 med pkt1	1	1.5	VAL622	exhaust filter	1	9.19	VAL815	3/2 solenoid/spring valve g1/8	1	9.10
RA773	swivel stud m12x1.5 med pkt1	1	1.5	VAL623	pressure regulator g1/4" (relieving)	1	9.16	VAL816	3/2 red button/spring valve g1/8	1	9.5
RA774	swivel stud m14x1.5 med pkt1	1	1.5	VAL624	pressure regulator g1/2" (relieving)	1	9.17	VAL823	pressure regulator g1/4"	1	9.16
RA775	swivel stud m16x1.5 med pkt1	1	1.5	VAL625	3/2 limit switch slider adjust g1/8	1	9.9	VAL839	3/2 emergency stop valve red	1	9.4
RA777	swivel stud m22x1.5 med pkt1	1	1.5	VAL626	3/2 push pull valve	1	9.7	VAL857	pressure regulator g1/4	1	9.17
RA780	straight coupling 6x1	1	1.8	VAL627	3/2 roller lever/spring valve	1	9.8	VAL866	3/2 roller lever spring valve g1/4	1	9.8
RA781	straight coupling 8x1	1	1.8	VAL628	3/2 roller trip valve nc g1/8	1	9.7	VAL868	3/2 solenoid/spring valve g1/4	1	9.10
RA782	straight coupling 10x1	1	1.8	VAL629	3/2 push/pull val pilot ret m14	1	9.6	VAL872	gauge	1	9.20
RA783	straight coupling 10x1.25	1	1.8	VAL630	3/2 pilot/pilot valve g1/4	1	9.4	VAL874	5/3 lever spring lever valve g1/4	1	9.15
RA784	straight coupling 10x1.5	1	1.8	VAL632	3/2 push pull valve	1	9.7	VAL878	5/2 push/pull valve g1/4	1	9.13
RA785	straight coupling 12x1.5	1	1.8	VAL633	rota wink off black/on green	1	9.16	VAL884	5/2 lever/lever valve g1/4	1	9.14
RA795	rotaloc 22mm hex medium pkt2	2	1.9	VAL634	filter/regulator	1	9.21	VAL896	5/2 pilot spring valve g1/4	1	9.12
RA796	rotaloc 28mm hex medium pkt2	2	1.9	VAL637	3/2 foot button valve	1	9.9	VAL898	5/2 Emergency Stop Valve g1/8	1	9.13
V231019	coupling box 200x605x120	1	10.7	VAL638	3/2 push/pull valve pilot ret g1/8	1	9.7	VAL922	3/2 lever spring valve g1/4	1	9.6
V231046	coupling box 450x305x120	1	10.7	VAL639	3/2 emergency stop valve	1	9.4	VOS702	male nut ng8 230 pkt1	1	1.35
V233067	side guard leg kit 706mm lg bzp	1	10.8	VAL641	3/2 pilot spring valve n/c g1/8	1	9.4	VOS703	male nut ng12 230 pkt1	1	1.35
V234001	trailer handbrake	1	10.12	VAL643	3/2 pilot spring valve n/o g1/4	1	9.3	VOS706	adaptor ng8-m16x1.5 230 pkt1	1	1.34
V234395	compensator 390-420mm crs	1	10.12	VAL644A	5/32 pilot spring valve	1	9.12	VOS712	adaptor ng12-m16x1.5 230 pkt1	1	1.34

Need help with your order?

Please contact

TGL
TUBE GEAR

TUBE GEAR LTD.

Tel: +44 (0)1474 321954

E: orders@tube-gear.com

Unit B, Mucklow Hill Trading Estate
Phase 2
Halesowen
West Midlands
B62 8DQ